

JAMICON Catalogue - Aldinet

1. Index.....	1
2. Aluminum Electrolytic Capacitors	2

JAMICON TEAPO

Aluminum Electrolytic Capacitors
铝电解电容器



凯美电机股份有限公司
KAIMEI ELECTRONIC CORP.



Company Profile

Established:	TEAPO ELECTRONICS CORP. (TEAPO) formally established on Sept. 11th 1978
Capital :	USD 64 million
Revenue :	
Employees :	1000
Listing :	August 29th 1998, Taiwan Stock Exchange
Stock Code :	TWSE 2375
Capacity :	450 million pcs/month
Product Lines :	Aluminum Electrolytic Capacitor Conductive Polymer Solid Aluminum Electrolytic Capacitor

Milestones:	1956	Set-up Aluminum Electrolytic Capacitor Division at SAMPO Electronic
	1965	Technical cooperation with ELNA Japan
	1966	Technical cooperation with HITACHI Japan
	1971	Technical cooperation with SHINYEI Japan
	1975	First development and mass production at Low ESR product in Taiwan
	1978	Foundation of TEAPO ELECTRONICS CORP.
	1995	Foundation of SUZHOU KAIMEI ELECTRONICS CO., LTD
	1998	Company stock listed in OTC market in Taiwan
	1998	Foundation of TEAPO ELECTRONIC (DONGGUAN) CO., LTD
	2001	Certified by ISO9001:2000
	2005	Merge G-LUXON ELECTRONICS CORP.
	2006	Development and mass production of Conductive Polymer Solid Aluminum Electrolytic Capacitor
	2008	Certified by ISO9001:2008
	2010	Certified by ISO14001:2004
	2014	Certified by ISO/TS16949:2009
	2014	Certified by IECQ/QC080000:2012
	2014	Certified by OHSAS 18001:2007
	2016	Pass global supply chain qualification audit of JABIL and audit of SUNGROW
	2019	Merge KAIMEI ELECTRONICS CORP.
	2019	TEAPO ELECTRONICS CORP. was renamed KAIMEI ELECTRONICS CORP.

Catalogue content

● Product Guide

	Page
1. Products Series Table	1
2. Products Group Chart	4
3. Industry Application	8
4. Part Number System	9
5. Taping specifications for Radial Type	11
6. Lead Cut/Forming for Radial Type	12
7. Terminals for Snap-in Type	13
8. Packaging specification	14
9. Usage conditions of Conductive Polymer Hybrid Capacitors	18
10. Precautions in Using Polymer solid aluminum electrolytic capacitor	21
11. Usage conditions of Aluminum Electrolytic Capacitors	25
12. Precautions in Using Aluminum Electrolytic Capacitors	29

● Conductive Polymer Aluminum Solid Capacitors

1. SMD Type Conductive Polymer Aluminum Solid Capacitors	33
2. Radial Type Conductive Polymer Aluminum Solid Capacitors	47
3. Hybrid Capacitors Type Conductive Polymer	67

● Aluminum Electrolytic Capacitors

1. Surface Mount Aluminium Electrolytic Capacitors	71
2. Radial Type Aluminium Electrolytic Capacitors	105
3. Snap-in Type Aluminium Electrolytic Capacitors	191
4. Screw Type Aluminium Electrolytic Capacitors	243

Products Series Table

■ Conductive Polymer Aluminum Solid Capacitors

Classify				Pages	Features	Standard Type	Miniaturization	Long life	Low impedance	High Ripple	Endurance (+R=With ripple)	Rated voltage range (Vdc)
Type	JAMICON	TEAPO	G-LUXON									
SMD Types	VP	VP	VP	33	Standard	*					105°C 2000hours	2.5~25
	VC	VC	VC	35	Vehclar Special	*					105°C 2000hours	2.5~25
	VB	VB	VB	37	High capacitance & Low ESR				*		105°C 2000hours	2.5~50
	VS	VS	VS	39	Long Life & Low ESR			*	*		105°C 5000hours	4~25
	VA	VA	VA	41	Long Life 15000hrs			*			105°C 15000hours	6.3~25
	VD	VD	VD	43	Long Life 20000hrs			*			105°C 20000hours	6.3~25
	VQ	VQ	VQ	45	125°C/2000hrs&Low ESR			*			125°C 2000hours	2.5~25
Radial Types	FG	FG	FG	47	Standard	*					105°C 2000hours	2.5~25
	FR	FR	FR	49	High Ripple & Low ESR					*	105°C 2000hours	2.5~6.3
	FF	FF	FF	51	Large Capacitance				*		105°C 2000hours	6.3~100
	FL	FL	FL	53	Special for Charger	*					105°C 2000hours	6.3~16
	FS	FS	FS	55	Large Capacitance&Long Life&High Voltage			*			105°C 5000hours	20~50
	FP	FP	FP	57	8mm height & Low ESR		*		*		105°C 3000hours	2.5~25
	FH	FH	FH	59	Long life & Low ESR			*			105°C 5000hours	2.5~16
	FC	FC	FC	61	Long Life 15000hrs			*			105°C 15000hours	6.3~80
	FB	FB	FB	63	Long Life 20000hrs			*			105°C 20000hours	6.3~80
	FT	FT	FT	65	125°C/2000hrs&Low ESR			*			125°C 2000hours	6.3~25

■ Conductive Polymer Hybrid Capacitors

Classify				Pages	Features	Standard Type	Miniaturization	Long life	Low impedance	High Ripple	Endurance (+R=With ripple)	Rated voltage range (Vdc)
Type	JAMICON	TEAPO	G-LUXON									
SMD	YA	YA	YA	67	Standard	*					105°C 2000hours	16~25
Radial	YX	YX	YX	69	Standard	*					105°C 2000hours	16~35

■ Surface Mount Aluminum Electrolytic Capacitors

Classify				Pages	Features	Standard Type	Miniaturization	Long life	Low impedance	High Ripple	Endurance (+R=With ripple)	Rated voltage range (Vdc)
Type	JAMICON	TEAPO	G-LUXON									
General Purpose	CS	GV	GV	71	General purpose	*					85°C 2000hours	4~100
	CT	SV	SV	74	General purpose	*					105°C 1000hours	4~100
	CH	DV	DV	76	General purpose 、 High voltage purpose	*					105°C 2000hours	6.3~450
Low Impedance or long life	CW	FV	FV	79	Long Life			*			85°C 3000~5000hours	4~100
	CK	PV	PV	81	Low Impedance	*					105°C 1000~2000 hours	6.3~ 50
	CL	YV	YV	83	Low Impedance				*		105°C 1000~2000hours	6.3~50
	CE	MV	MV	85	Low leakage current						105°C 2000 hours	6.3 ~ 50
	CF	EV	EV	87	Low impedance				*		105°C 2000 hours	6.3~50
	CD	LV	LV	89	Low Impedance 、 long life Series	*					105°C 2000~5000 hours	6.3~ 50
	CU	WV	WV	91	Long Life			*			105°C 3000~5000 hours	6.3~ 50

Products Series Table

■ Surface Mount Aluminum Electrolytic Capacitors

Classify				Pages	Features	Standard Type	Miniaturization	Long life	Low impedance	High Ripple	Endurance (+R=With ripple)	Rated voltage range (Vdc)
Type	JAMICON	TEAPO	G-LUXON									
Low Imp.	CZ	XV	XV	93	Ultra Low Impedance · Long Life	*					105°C 3000~5000hours	6.3~50
	CJ	AV	AV	95	Low Impedance · long life			*	*		105°C 5000 hours	6.3~50
Special Purpose	CA	CV	CV	97	Low Leakage current	*					85°C 2000 hours	6.3~50
	CN	RV	RV	99	Non-polar	*					85°C 2000 hours	6.3~50
	CP	NV	NV	101	Non-polar	*					105°C 2000 hours	6.3~50
	CB	HV	HV	103	High temperature			*			125°C 1000~2000hours	10~50

■ Radial Type Aluminum Electrolytic Capacitors

Classify				Pages	Features	Standard Type	Miniaturization	Long life	Low impedance	High Ripple	Endurance (+R=With ripple)	Rated voltage range (Vdc)
Type	JAMICON	TEAPO	G-LUXON									
Low Profile	ST	S5	FX	105	Low profile		*				105°C 1000hours+R	6.3~50
	SH	S7	SX	107	Low profile		*				105°C 1000hours+R	6.3~63
	H5	H5	H5	109	Low profile		*				105°C 2000 hours+R	6.3~50
	H7	H7	H7	111	Low profile		*				105°C 2000 hours+R	6.3~63
General Purpose	SK	SK	GR	113	Standard	*					85°C 2000hours+R	6.3~550
	TK	SH	SM	116	Standard	*					105°C 2000hours+R	6.3~550
Low Impedance	SZ	SZ	LW	120	Ultra low impedance				*		105°C 2000hours+R	6.3~16
	MZ	MZ	MZ	122	Ultra low impedance				*		105°C 2000hours+R	6.3 ~ 25
	WL	WL	WL	124	Low impedance				*		105°C 1000~2000hours+R	6.3~ 63
	TL	SJ	LU	128	Low impedance · High Ripple			*	*		105°C 1000~5000hours+R	6.3~100
	SC	SC	LZ	131	Low impedance · High Ripple				*		105°C 2000~3000hours+R	6.3~100
	WG	WG	WG	134	Low impedance · High Reliability				*		105°C 2000~3000hours+R	10~ 100
	TE	SY	LT	136	Low impedance · Long life			*	*		105°C 3000~6000hours+R	6.3~100
	TT	TA	TA	139	Low impedance · Long life			*	*		105°C 4000~10000hours+R	6.3~100
	TV	ST	ST	142	Low impedance · Long life(No water)			*	*		105°C 4000~10000hours+R	6.3~100
	SA	TT	TT	145	Low impedance · Long life · Miniaturization (No water)		*	*	*		105°C 5000hours+R	6.3~50
	TQ	TB	TB	147	Low impedance · High Ripple			*	*		105°C 5000~6000hours+R	6.3~35
	TU	TC	TC	149	Low impedance · Long life			*	*		105°C 6000~10000hours+R	6.3~100
High Ripple	TC	SQ	LB	152	High Ripple					*	105°C 2000hours+R	160~500
	TH	TH	TH	155	High Ripple · Low impedance				*	*	105°C 2000 ~3000hours+R	160 ~ 400
	TJ	SG	LC	157	High Ripple · Long life			*	*		105°C 3000~5000hours+R	160~500
	TX	TX	TX	160	High Ripple · Low impedance			*	*	*	105°C 3000~5000hours+R	160 ~ 450
	TF	SP	SP	162	High Ripple · Long life			*	*	*	105°C 8000~10000hours+R	160~500
	TR	SU	SU	164	High Ripple · Long life			*	*	*	105°C 10000~12000hours+R	160~450
	TS	TS	TS	166	High Ripple · Long life			*	*	*	105°C 15000~20000hours+R	160~450
High Temperature	WB	AK	AK	168	High Temperature · Ultra Long Life			*	*		125°C 2000-5000hours+R	10~450
	WF	AR	AR	170	High Tem. · Low impedance · Ultra long Life			*	*		125°C 3000~5000hours+R	25~63
	WH	AT	AT	172	High Temperature · Ultra Long Life			*	*		130°C 1000-4000hours+R	10~63
	AU	AU	AU	174	High Temperature · Ultra Long Life			*	*		135°C 1000-3000hours+R	10~63

Products Series Table

■ Radial Type Aluminum Electrolytic Capacitors

Classify				Pages	Features	Standard Type	Miniaturization	Long life	Low impedance	High Ripple	Endurance (+R=With ripple)	Rated voltage range (Vdc)
Type	JAMICON	TEAPO	G-LUXON									
Special Purpose	NK	RN	RN	176	Non-polar Standard	*					85°C 2000hours+R	6.3~250
	SN	SN	RX	179	Non-polar Standard	*					105°C 2000hours+R	6.3~250
	LK	LL	LL	181	Low Leakage current	*					85°C 2000 hours+R	10~63
	SB	SB	LX	183	Low Leakage current	*					105°C 2000hours+R	6.3~100
	RV	MA	MA	185	No Spark with DC Overvoltage	*					105°C 2000hours+R	200~400
	TP	TP	TP	187	High Temperature · Long Life			*			105°C 6000~20000hours+R	10~35
	TW	TE	TE	189	LED Lighting · Ultra Long Life			*			105°C 12000~20000hours+R	160~400

■ Snap-in Type Aluminum Electrolytic Capacitors

Classify				Pages	Features	Standard Type	Miniaturization	Long life	Low impedance	High Ripple	Endurance (+R=With ripple)	Rated voltage range (Vdc)
Type	JAMICON	TEAPO	G-LUXON									
General Purpose	LS	LH	TW	191	Standard	*					85°C 2000hours+R	6.3~550
	HS	LG	HW	197	Standard	*					105°C 2000hours+R	6.3~550
Long life	LT	LF	LF	203	Long Life			*	*		85°C 3000hours+R	10~550
	LB	GA	GA	208	Long Life · Large Capacitance			*			85°C 3000hours+R	16~550
	LL	GC	GC	212	Long Life						85°C 5000hours+R	160 ~ 450
	HT	LJ	LJ	214	Long Life			*	*		105°C 3000hours+R	10~550
	HB	GB	GB	220	Long Life · Large Capacitance			*			105°C 3000hours+R	16~500
	HL	LQ	LQ	224	Long Life			*	*		105°C 5000hours+R	160~550
	HF	LK	LK	227	Long Life			*			105°C 7000hours+R	160~450
Miniaturization	HX	LP	LP	230	Long Life			*			105°C 10000hours+R	200~450
	HM	LS	LS	232	Downsized · Low profile		*				105°C 2000hours+R	160~450
	LR	LR	LR	235	Downsized · Low profile			*			105°C 2000hours+R	400~450
Special Purpose	LM	LM	LM	237	Downsized · Low profile · Long Life		*	*			105°C 3000hours+R	400~450
	LA	LA	LA	239	Charge-Discharge Facility Series	*					105°C 3000hours+R	350~450
	HV	GD	GD	241	No Spark with DC Overvoltage	*					105°C 3000hours+R	200~ 400

■ Screw Type Aluminum Electrolytic Capacitors

Classify				Pages	Features	Standard Type	Miniaturization	Long life	Low impedance	High Ripple	Endurance (+R=With ripple)	Rated voltage range (Vdc)
Type	JAMICON	TEAPO	G-LUXON									
General Purpose	KP	KP	KP	243	Standard	*				*	85°C 2000hours+R	6.3~450
	WP	WP	WP	247	Standard · High Ripple	*				*	85°C 2000hours+R	160~550
	QP	QP	QP	249	Standard · High Ripple	*				*	105°C 2000hours+R	160~500
	RP	RP	RP	251	Wide temperature range standard	*					105°C 2000hours+R	10~450
Long life	MP	MP	MP	253	High voltage · Long life			*			85°C 5000hours+R	350~450
	XP	XP	XP	255	High voltage · Long life			*	*		105°C 5000hours+R	200~450
	JP	JP	JP	257	High voltage · Long life			*			85°C 10000hours+R	350~450
	EP	EP	EP	259	High voltage · Long life			*			105°C 10000hours+R	350~450

Systematic Diagram of Capacitor

Conductive Polymer Aluminum Solid Capacitors: Radial Type

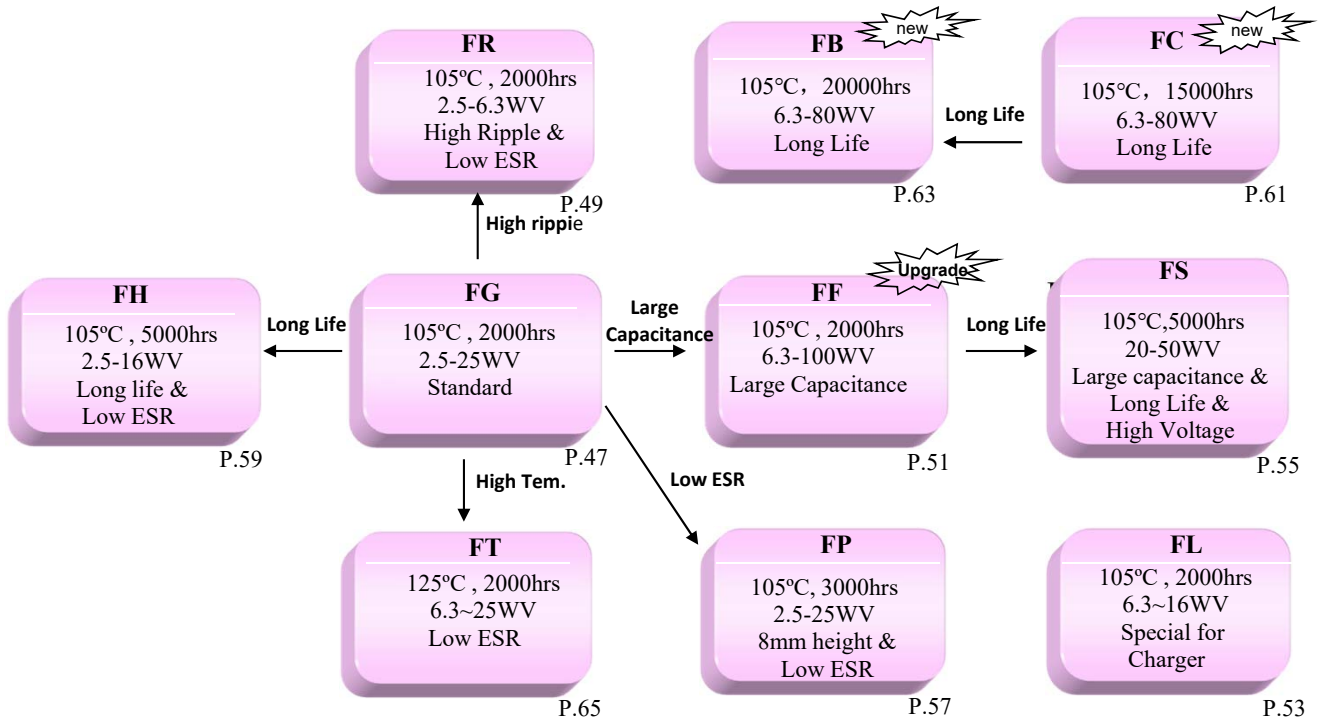

Conductive Polymer Aluminum Solid Capacitors: SMD Type

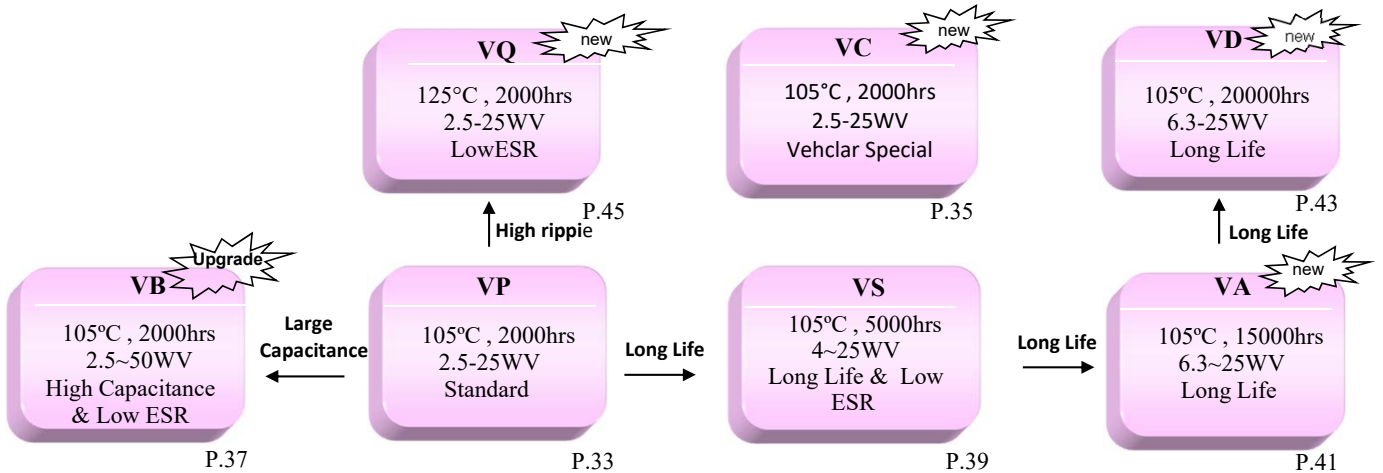

Conductive Polymer Hybrid Capacitors

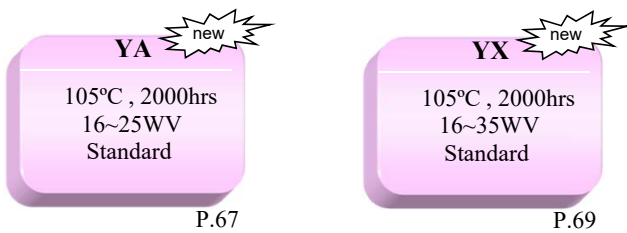

Systematic Diagram of Capacitor

Surface Mount Aluminum Electrolytic Capacitors

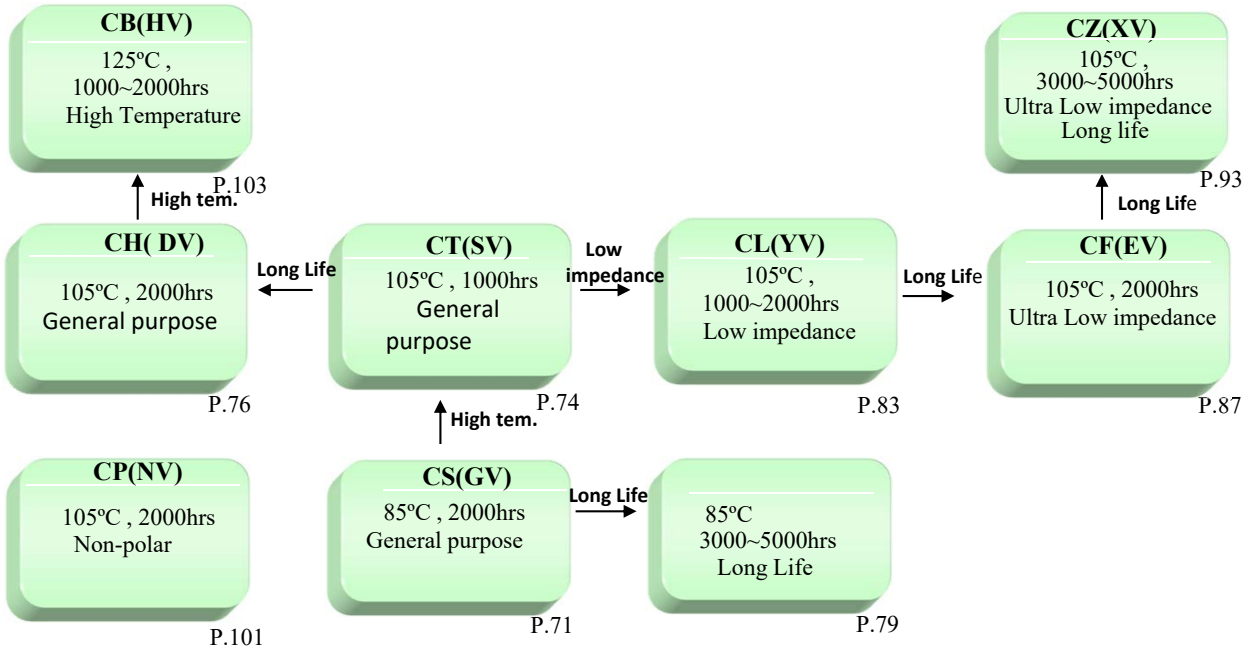

Radial Type Aluminum Electrolytic Capacitors:

Low profice

Standard :

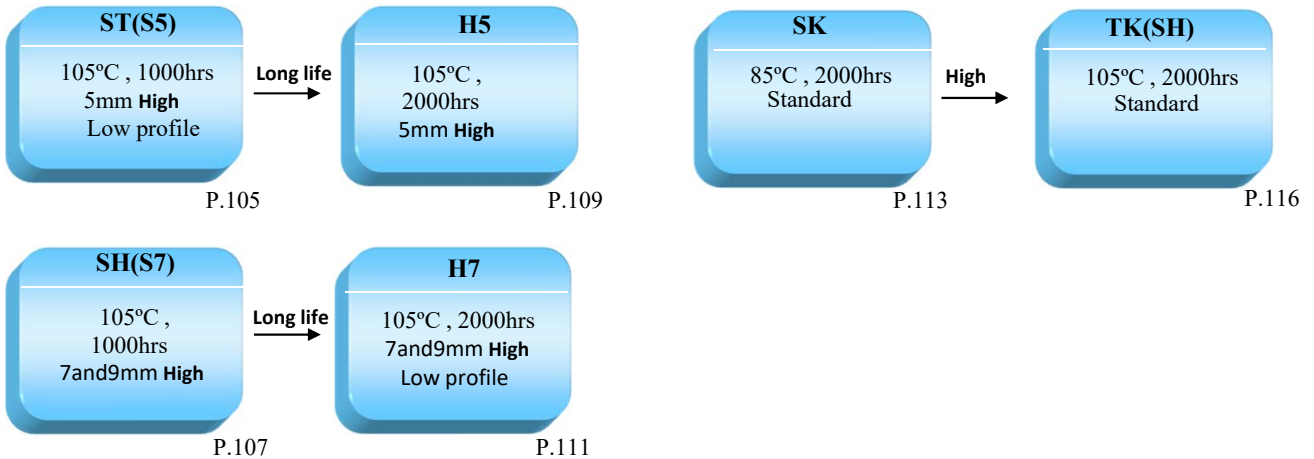

Low ESR (For Power Output Smoothly Current Using) :

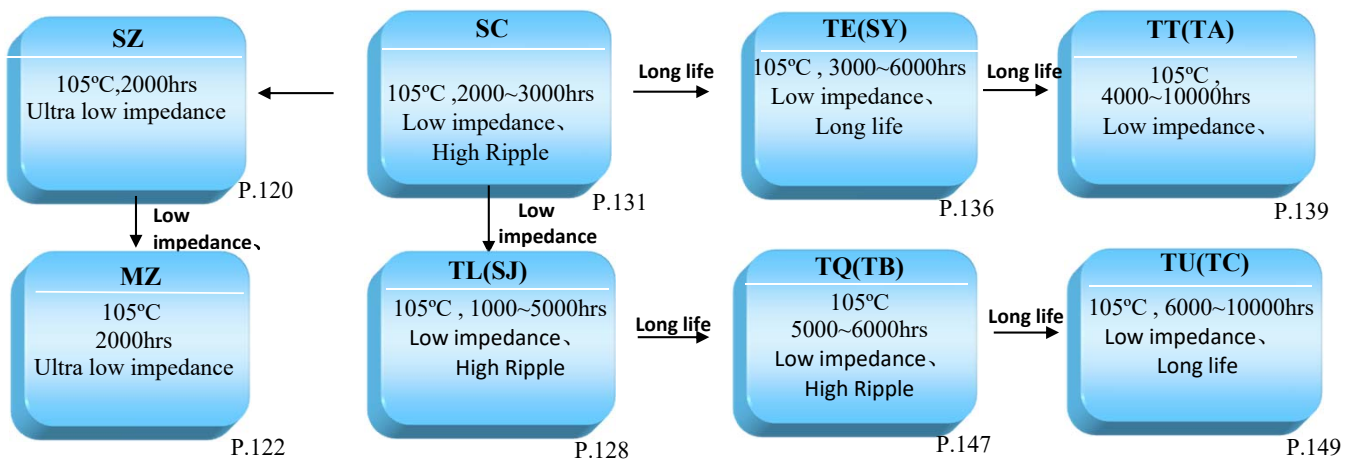

Systematic Diagram of Capacitor

High Ripple (Power Input Smoothly Current Using) :

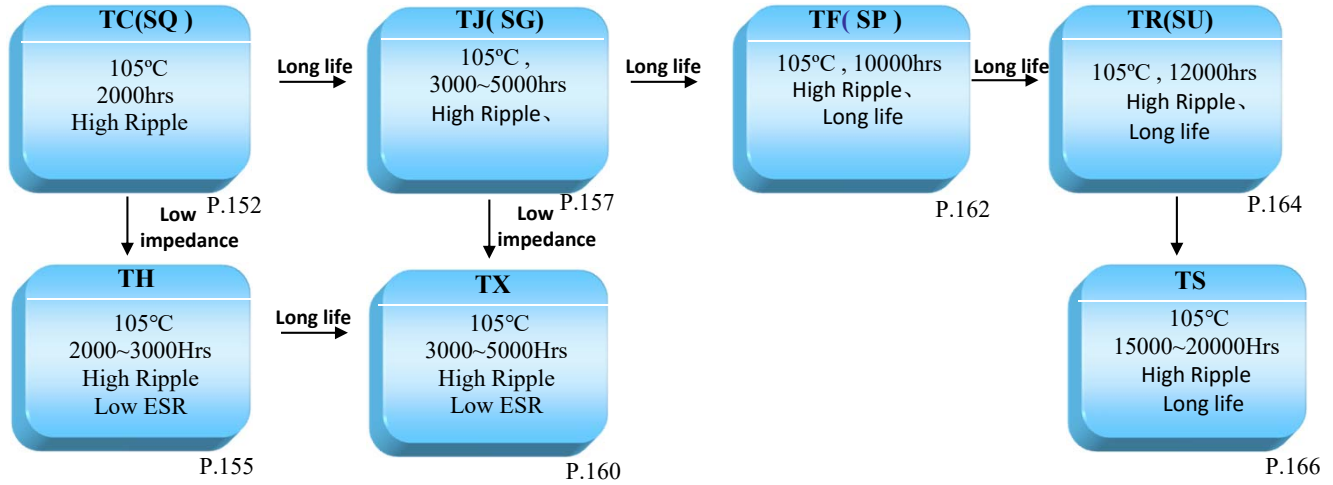

Products For Special Purpose :

Non-polar (For Audio Coupling Using)

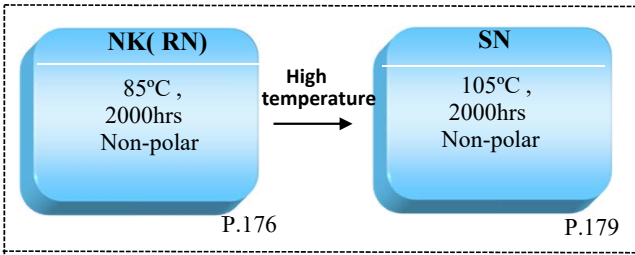

LED Lighting

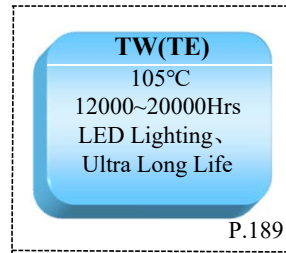

Low leakage current

Low leakage current

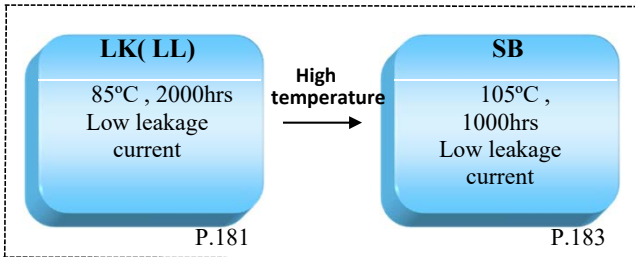

No water (LED Lighting & for Vehicle-Mounted)

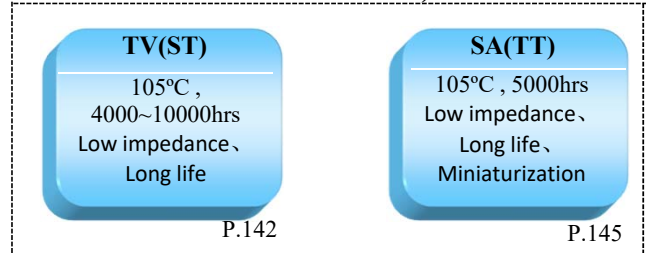

High Temperature (For Vehicle-Mounted)

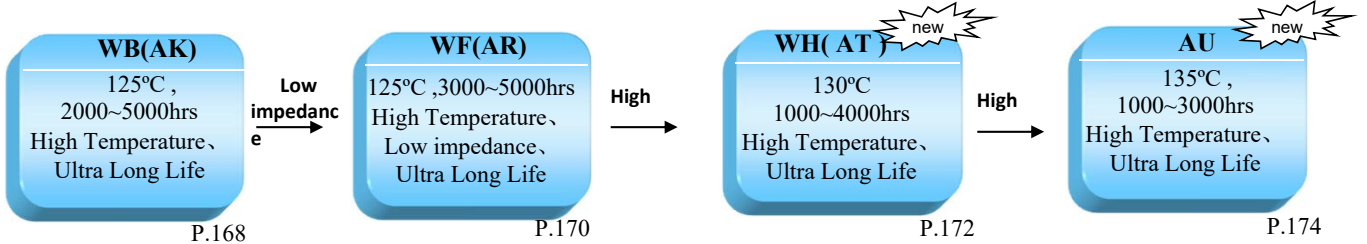

Systematic Diagram of Capacitor

Snap-in Type Aluminum Electrolytic Capacitors (Power input or output):

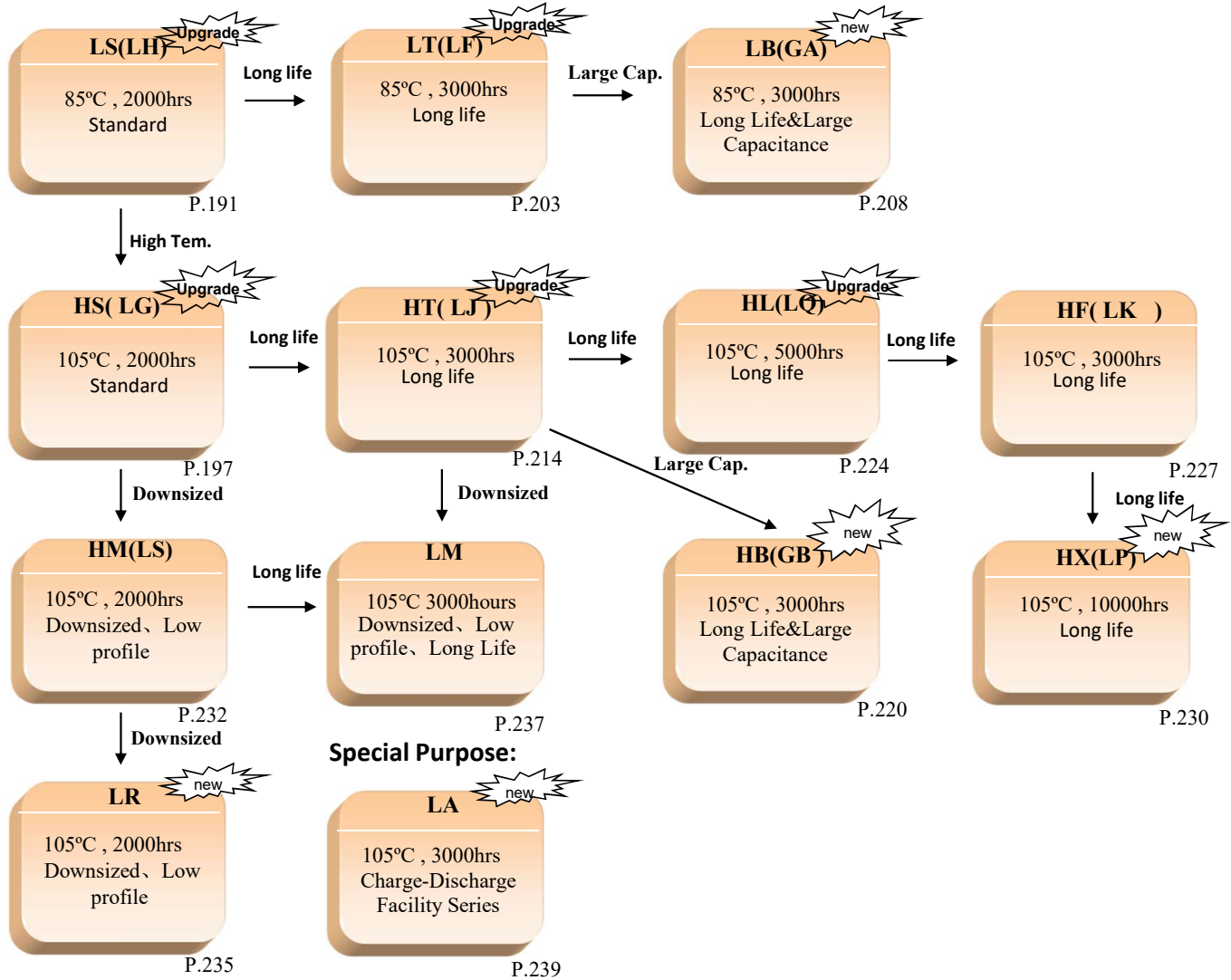

Screw Type Aluminum Electrolytic Capacitors (For Frequency Converter Using)

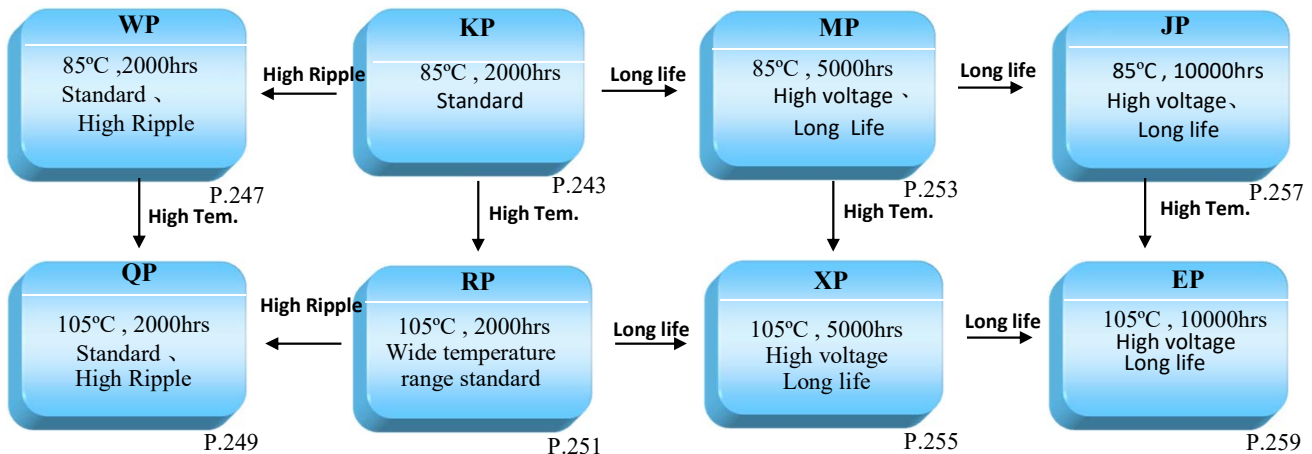

Industry Application

Recommended Applications	Conductive Polymer Aluminum Solid Capacitor	SURFACE MOUNT	RADIAL LEAD TYPE 6.3~100V	RADIAL LEAD TYPE 160~500V	SNAP-IN TYPE	SCREW TYPE
Charger	FL	CS(GV)・CT(SV)・CH(DV)・CF(EV)・CZ(XV)	SC(SC)・SL(SJ)	TK(SH)	—	—
Lighting Equipment	FG・FF	CB(HV)	TV(ST)・TT(TA)・TU(TC)	TW(TE)・TJ(SG)・TR(SU)	—	—
Network Communication	FG・FF・FB・VD	CF(EV)・CH(DV)・CZ(XV)・CB(HV)	TZ(SJ)・TE(SY)・TT(TA)・TU(TC)	TJ(SG)・TF(SP)・TR(SU)	—	—
Power Supply	FG・FC・FT・VQ	CS(GV)・CT(SV)・CH(DV)・CF(EV)・CZ(XV)	TK(SH)・TE(SY)	TK(SH)・TJ(SG)	—	—
Control Panel	VP・FG	CS(GV)・CT(SV)・CH(DV)	TK(SH)・SC(SC)	TK(SH)	—	—
Audio	VP・FG	CS(GV)・CH(DV)・CF(EV)・CZ(XV)・CP(NV)	SC(SC)・TK(SH)・SK(SK)	—	LS(LH)・HS(LG)・HT(LJ)	—
Intelligent Electric Meters Intelligent Water Meter Intelligent Gas Meter	FH・FS・YX・YA	CF(EV)・CZ(XV)・CH(DV)	TK(SH)・TE(SY)・TT(TA)	TK(SH)・TJ(SG)・TC(SQ)	HS(LG)・HT(LJ)	—
UPS	FG	CH(DV)	—	—	HM(LS)・HF(LK)・HX(LP)	MP
Inside and Outside Accessories for Automotive	VC・FG	CF(EV)・CZ(XV)・CH(DV)	SK(SK)・TK(SH)・TZ(SJ)・TE(SY)・	—	—	—
Ethernet Router Interchanger	FG	CH(DV)・CF(EV)	SC(SC)・TT(TA)	—	—	—
Servosystem	FP	CH(DV)・CZ(XV)	—	TJ(SG)・TR(SU)	LM・HL(LQ)	MP・XP
Plastic Working Equipment	—	—	—	—	LM・HL(LQ)	MP・XP
Electric Car Equipment Charging pile	FG・VP	CH(DV)	—	—	HS(LG)・HL(LQ)	MP・XP
Inverter	—	CH(DV)・CF(EV)・CZ(XV)	—	TR(SU)	HT(LJ)・HL(LQ)・HF(LK)・HX(LP)	MP・XP・EP
Inverter Air-Conditioner Inverter Washing Machine Inverter Refrigerator	VS・VA・FH・FB	CH(DV)・CF(EV)・CZ(XV)	TK(SH)	TF(SP)・TR(SU)	HS(LG)・HL(LQ)・HX(LP)・LM LT(LF)・	MP・XP・EP
Printer Facsimile Machine	VS・VA・FH・FB	CH(DV)・CF(EV)・CZ(XV)	—	TC(SQ)・TJ(SG)	HS(LG)・HM(LS)	—
Elevator	—	CH(DV)	SK(SK)・TK(SH)・TV(ST)・TT(TA)・TE(SY)	TK(SH)・TJ(SG)・TF(SP)	HS(LG)・LH・HM(LS)・HL(LQ)・HX(LP)	—
Mainboard	FG・VB	CS(GV)・CT(SV)・CH(DV)	SK(SK)・TK(SH)	SK(SK)・TK(SH)	—	—

Part Number System

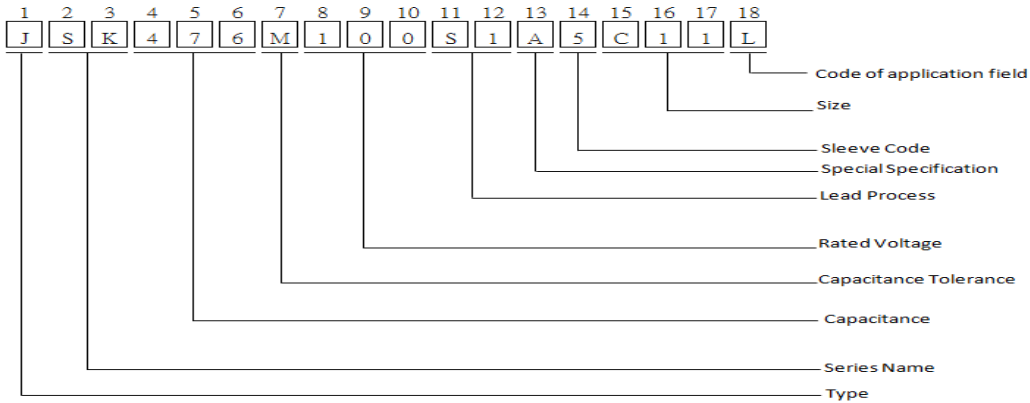

Code 1

Type

Code	Model Type
J	Jamicon Radial Type (PET sleeve)
K	Teapo Radial Type (PET sleeve)
V	SMD (V-chip) Type (Nylon coating)
S	TEAPO Snap-in Type (PET sleeve)
T	JAMICON Snap-in Type (PET sleeve)
H	JAMICON Snap-in Type (No Insulating base, PET sleeve)
P	Conductive Polymer Aluminum Solid Capacitor
N	Screw Type(PVC sleeve)
B	Radial Type special for CP line(PET sleeve)
M	Radial Type 8 φ pitch =2.5mm(PET sleeve)
G	G-LUXON Radial Type (PET sleeve)
R	Conductive Polymer Hybrid Aluminum Electrolytic Capacitors
Z	Teapo Snap-in Type (No Insulating base, PET sleeve),the last code "0" is for G-LUXON Snap-in Type (No Insulating base, PET sleeve)

Code 2~3

Series Name (as content page 2 to page 4)

Code 4~6

Capacitance

Capacitance(uf)	0.47	4.7	47	470	4700	47000	470000	4700000	47000000	470000000
product code	474	475	476	477	478	479	47A	47B	47C	47D

Code 7

Capacitance Tolerance

A : - 8~ + 32%	B : - 5~ + 10%	C : + 10~ + 30%	D : - 40~ + 0%	W : - 15~ + 0%	X : - 15~ + 5%
G : - 30~ + 0%	H : - 5~ + 15%	I : - 20~ + 0%	J : - 5~ + 5%	Q : - 10~ + 30%	R : - 0~ + 20%
M : - 20~ + 20%	N : - 30~ + 30%	O : - 20~ + 10%	P : - 0~ + 30%	K : - 10~ + 10%	L : - 15~ + 15%
S : - 0~ + 50%	T : - 10~ + 50%	U : - 10~ + 75%	V : - 10~ + 20%	E : - 12~ + 20%	F : - 5~ + 20%
Y : - 10~ + 150%	Z : - 20~ + 80%				

Code 8~10

Rated Voltage

Rated Voltage(WV)	2.5	5	6.3	63	100	450
product code	2R5	005	6R3	063	100	450

Code 11~12

Lead Process

Code processing form	Code 11	Code 12	Description
Standard	A	1	Screw type standard type
	S	0	Standard SMD type
		1	Standard Dip & Snap-in type
Ammo tape	T	1	Standard ammo tape (pitch 5mm for dia. ~ 13mm)
		2	Ammo tape with straight lead (available for dia. 4~8mm)
		4	Ammo formed tape with pitch 2.5mm (available for dia.4~5mm)
Reel tape	R	1	Standard reel tape (pitch 5mm for dia.~ 10mm)
		2	Reel tape with straight lead (available for dia. 4~8mm)
		3	Reel formed tape with pitch 2.5mm (available for dia.4~5mm)
Straight cut	C	3	Straight cut lead with L : 3.2+/-0.5mm
		5	Straight cut lead with L : 4.0+/-0.5mm
		7	Straight cut lead with L : 5.0+/-0.5mm
Kink(Crimp)cut	K	2	Kink cut lead with L : 4.5+/-0.5mm
Formed cut	F	6	Forming cut lead with L : 4.0+/-0.5 (Pitch : 5mm)

Code 13 Special Specification

A	Standard	J	S-protection	S	spacer special DIP special	2	Life & ESR special
B	DF (tanδ)special	K	Above life specified in catalog	T	length of body special fortolerance	3	Life & Impedance special
C	ESR special	L	Pins or Wire diameter	U	Pack special	4	Life & Ripple current
D	Impedance special	M	Customer requirements	V	Sleeve special	5	Life & LC special
E	Ripple current special	N	Pitch special	W	Capacitance special	6	life & rubber cover or
F	LC special	O	LC & ESR or Impedance special	X	DF & LC & ESR or Impedance special	7	DF & ESR or Impedance special
G	GUM or special for capacitor cover plate or non-salient point in bottom	P	Under life specified in catalog	Y	RC & LC & ESR or Impedance special	8	DF & RC special
H	Customer requirements	Q	DF & Ripple current & ESR or Impedance special	Z	Frequency & ESR or Impedance special	9	DF & LC special
I	RC & LC special	R	Shelf is 1000Hrs	1	Life & DF special	0	RC & ESR or Impedance

Code 14 Sleeve Code (please contact us if the sleeve code in the form cannot corresponding with your requirement.)

代碼	Color	JAMICON	TEAPO
1	Dark blue with white	/	SK
5	Black with white printing	NK,SK,TE,TQ,TT,TV,TP,TR,TW,SA,RV,HF,HM,HS,HT,LS,HV,HX,WB,WH,LB,HB,KP,MP,WP,QP,RP,XP,JP,EP,MP	SH,SG,SP,SB,SY,SJ,RN,SQ,AK,ST,TA,SU,TB,LH,LG,LJ,LF,LQ,LM,TE,LS,LK,TT,S5,S7,H5,H7,KP,WP,QP,MP,XP,JP,MA,TP,LA,GA,GB
6	Black with golden printing	TU,WF	TC
C	Green with golden printing	SL,WL,TF	SC,WL
H	Royal blue with golden printing	/	SZ
N	SMD standard pack & POLYMER	CA,CD,CE,CJ,CK,CN,CU,CS,CW,CT,CH,CL,CF,CZ,CB,CP,VP,VC,VB,VS,VA,VD,VQ,FG,FR,FF,FL,FS,FP,FH,FC,FB,FT,YA,XX	XV,LV,MV,AV,PV,RV,WV,GV,FV,SV,DV,YV,EV,XV,HV,NV,VP,VC,VB,VS,VA,VD,VQ,FG,FR,FF,FL,FS,FP,FH,FC,FB,FT,YA,XX
M	Black with blue printing	SH,ST,TK,TC	/
A	Green with black printing	LK,WB	LL
9	Green with silvery printing	MZ	MZ
B	Brown with white printing	TH,TL,HL,LL,HV	TH,GC,GD
Z	Brown with silver printing	TX,TJ,	TX
7	Green with white printing	LT,HT	/

Code 15~17 Case Size (Please contact us if the case size is required and not shown in the table.)

Code 15 Diameter

Code	A	B	C	D	E	F	G	8	H	9
Case size	3	4	5	5.5	6.3	7.3	8	8.2	10	10.2
Code	J	K	L	6	M	N	7	P	Q	R
Case size	12	12.5	13	14.5	16	18	18.5	20	22	25
Code	S	T	U	V	W	X	Y	Z	1	
Case size	30	35	40	45	51	64	77	90	101	

Code 16~17 Length

For ECAP-DIP & POLYMER-DIP & SNAP-IN & SCREW TYPE :

Code	05	07	09	10	1A	11	1B	12	1C	13
Length	05	07	09	10	10.5	11	11.5	12	12.5	13
Code	14	15	16	17	18	20	25	30	3B	32
Length	14	15	16	17	18	20	25	30	31.5	32
Code	35	3F	36	40	45	50	55	60	65	70
Length	35	35.5	36	40	45	50	55	60	65	70
Code	75	80	90	96	A0	B5	C1	D0	E4	F5
Length	75	80	90	96	100	115	121	130	144	155

For V-CHIP SMD

Code	01	02	03	04	05	06	07	08
Length	5.4	6.2	10.2	7.7	13.5	16、16.5	12.5	5.8

For POLYMER SMD

Code	A1	A2	A3	A4	A5	A6	A7	A8	A9
Length	5.8	6.0	6.7	7.7	10.2	10.4	12.0	12.2	9.0

Code 18 Code of application field

H: Intelligent instrument	R:Medical	X:Weekly date code	6:Industrial equipment / inverter
K:TEAPO	S:Auto grade	0:G.LUXON	L : JAMICON

Taping specifications for Roldal Type:

Fig.1 : Code T1/R1 : Ammo / Reel Tape (Φ4 - Φ6.3)

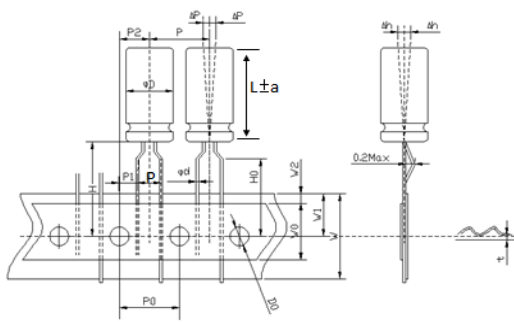

Fig.2 : Code T1/R1 : Ammo / Reel Tape (Φ8)(P3=2.0~2.7, θ=110°±15°)

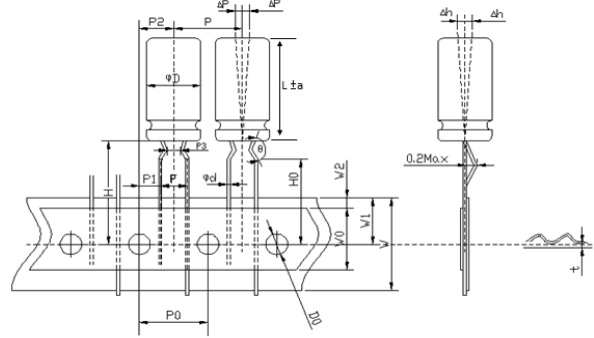

Fig.3 : Code T1/R1 : Ammo / Reel Tape (Φ10)

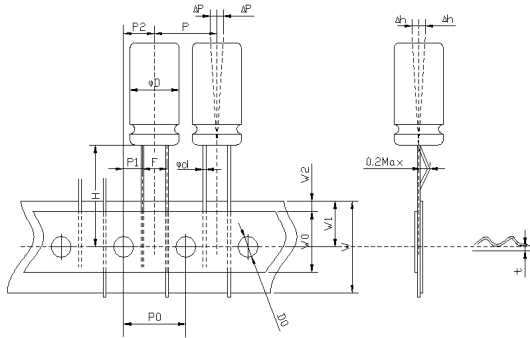

Fig.4 : Code T1 : Ammo Tape (Φ13~Φ18)

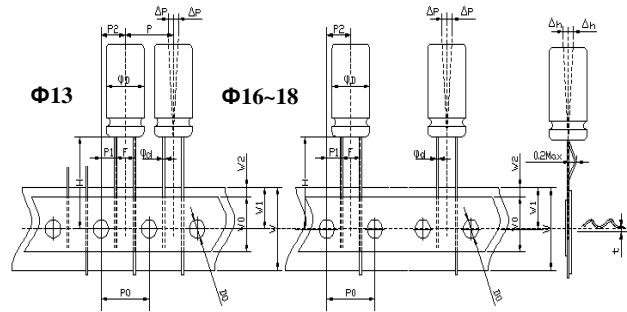

Fig.5 : Code T2/R2 , Φ4 ~ Φ8

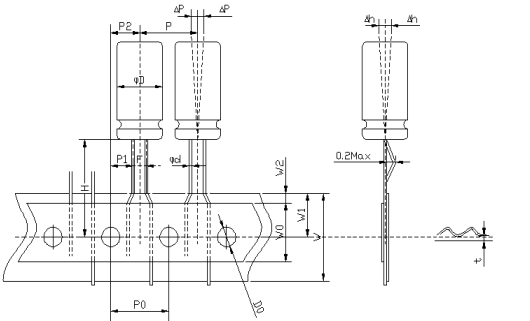
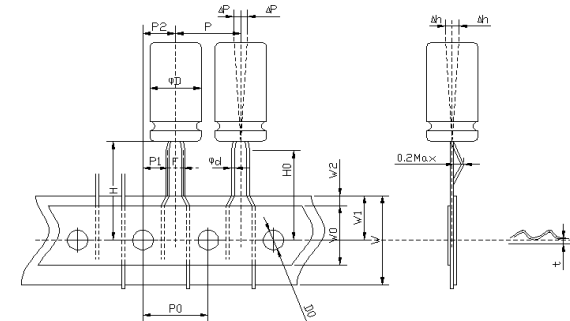

Fig.6 : Code T4/R3 : Ammo / Reel Formed Tape (Φ4~Φ5 / pitch 2.5mm)



unit : mm

Code	Symbol	φ d	P	P0	P1	P2	F	W	W0	W1	W2	H	H0	D0	ΔP	Δh	t	
T1/R1	Tolerance	±0.05	±1.0	±0.3	±0.5	±1.0	+0.6/- 0.2	±0.5	min	±0.5	max	±0.5	±0.5	±0.3	max	max	±0.3	
	4x5	0.45	12.7	12.7	3.85	6.35	5.0	18.0	8.0	9.0	2.0	18.5	16.0	4.0	0.2	0.2	0.6	
	5x5~11	0.45or0.5	12.7	12.7	3.85	6.35	5.0	18.0	8.0	9.0	2.0	18.5	16.0	4.0	0.2	0.2	0.6	
	6.3x5~11	0.45or0.5	12.7	12.7	3.85	6.35	5.0	18.0	8.0	9.0	2.0	18.5	16.0	4.0	0.2	0.2	0.6	
	Tolerance	±0.05	±1.0	±0.3	±0.7	±1.0	+0.6/- 0.2	±0.5	min	±0.5	max	±0.5	±0.5	±0.3	max	max	±0.3	
	8x5~30	0.45~0.6	12.7	12.7	3.85	6.35	5	18.0	8.0	9.0	2.0	18.5	16.0	4.0	0.2	0.2	0.6	
	Tolerance	±0.05	±1.0	±0.3	±0.5	±1.0	+0.6/- 0.2	±0.5	min	±0.5	max	±0.5	—	±0.3	max	max	±0.2	
	10x10~30	0.6	12.7	12.7	3.85	6.35	5	18.0	8.0	9.0	2.0	18.5	—	4.0	0.2	0.2	0.7	
	Tolerance	±0.05	±1.0	±0.3	±0.7	±1.3	+0.6/- 0.2	±0.5	min	±0.5	max	±0.5	—	±0.3	max	max	±0.3	
	12.5x15~25	0.6	15	15	5.00	7.50	5.0	18.0	8.0	9.0	2.0	18.5	—	4.0	0.2	0.2	0.7	
13x13~40	0.6	15	15	5.00	7.50	5.0	18.0	8.0	9.0	2.0	18.5	—	4.0	0.2	0.2	0.7		
16x16~40	0.8	30	15	3.75	7.50	7.5	18.0	8.0	9.0	2.0	18.5	—	4.0	0.2	0.2	0.7		
18x20~32	0.8	30	15	3.75	7.50	7.5	18.0	8.0	9.0	2.0	18.5	—	4.0	0.2	0.2	0.7		
T2/R2	Code	Symbol	Φ d	P	P1	P0	P2	F	W	W0	W1	W2	H	—	D0	Δp	—	t
	Tolerance	±0.05	±1.0	±0.5	±0.3	±1.0	+0.6/-0.2	±0.5	min	±0.5	max	±0.5	—	±0.3	max	—	±0.2	
	4x5~7	0.45	12.7	12.7	5.6	6.35	1.5	18	8	9	2.0	18.5	—	4	0.2	—	0.6	
	5x5~11	0.45or0.5	12.7	12.7	5.35	6.35	2	18	8	9	2.0	18.5	—	4	0.2	—	0.6	
	6.3x5~11	0.45or0.5	12.7	12.7	5.1	6.35	2.5	18	8	9	2.0	18.5	—	4	0.2	—	0.6	
8x5~20	0.6	12.7	12.7	4.6	6.35	3.5	18	8	9	2.0	18.5	—	4	0.2	—	0.6		
T4/R3	Code	sign	Φ d	P	P0	P1	P2	F	W	W0	W1	W2	H	H0	D0	ΔP	Δh	t
	Tolerance	±0.05	±1.0	±0.3	±0.5	±1.0	+0.6/- 0.2	±0.5	min	±0.5	max	±0.5	±0.5	±0.3	max	max	±0.3	
	4x5~4x7	0.45	12.7	12.7	5.1	6.35	2.5	18.0	8.0	9.0	2.0	18.5	17.0	4.0	0.2	0.2	0.6	
5x5~5x11	0.45or0.5	12.7	12.7	5.1	6.35	2.5	18.0	8.0	9.0	2.0	18.5	17.0	4.0	0.2	0.2	0.6		

Cut/Formatted Lead For Radial Lead Type :

Shape	Suitable size	Shape	Suitable size
Code C5 : Straight Cut 	ϕD=4~18	Code K2 : Kink cut, & Crimping 	ϕD=4~18
Code F* : Molding Truncation type 	ϕD=4~8	Code V*/O*/Z*/X* : Horizontal processing 	ϕD=4~18

unit : mm

C	Code	1	2	3	4	5	6	7	8	9	A	B	C	D	E	F	G	H
	L	2.5	2.8	3.2	3.4	4.0	4.5	5.0	5.5	6.5	7.0	8.0	10.0	3.6	6.0	3.2	4.2	2.4
	Code	J	K	L	M	N	P	Q	R	S	T	U	V	X	Y	Z	W	
	L	4.2	3.7	12.0	2.0	2.2	2.5	13.5	9.0	20.0	16.0	18.0	3.0	13.0	12.5	15.0	3.1	

P	Code	1	2	3					
	L	11.0	3.8	14.0					
K	Code	1	2	3	4	5	6	7	9
	L	3.2	4.5	5.0	3.5	4.0	4.3	3.5	3.2
	Code	A	B	D	E	F	H	K	L
	L	3.3	3.6	3.6	3.3	18.0	7.0	6.8	4.0

X	代碼	3
	L1	1.8±0.2
	L2	3.0±0.2

F	Code	1	2	3	4	5	6	7	8	9	A	B	C	D	E	F	G	H
	L	3.0	3.1	3.2	3.4	3.5	4.0	4.8	4.5	3.2	6.0	4.3	5.0	3.0	3.6	5.0	3.0	6.5
	Code	J	K	L	M	N	O	P	Q	R	S	T	U	V	W	Z	I	
	L	3.7	2.5	2.2	1.5	2.9	3.7	7.0	4.2	9.0	2.8	3.7	2.4	4.0	3.1	4.5	4.0	

V	Process number	1	2	6	J	Q	F	8	N
	L1	1.25±0.25	2.5±0.5	2.5±0.25	1.0±0.5	1.5±0.5	1.25±0.25	2.0±0.5	2.2±0.5
	L2	2.6±0.3	3.5±0.5	4.1±0.5	3.85±0.25	3.0±0.5	11.5±0.5	4.0±0.5	<3.6
	Process number	5	P	3	Y	R	G	9	Z
	L1	2.5±0.25	5.0±0.5	2.5±0.25	1.0±0.5	1.5±0.5	1.0±0.2	2.0±0.5	2.2±0.5
	L2	3.25±0.25	3.25±0.25	4.1±0.5	3.85±0.25	3.0±0.5	2.4±0.3	4.0±0.5	<3.6
	Process number	B	S	U	H	D	O	E	M
	L1	2.5±0.5	2.0±0.5	3.5±0.3	1.0±0.2	2.0±0.5	2.5±0.5	1.5±0.2	3.3±0.2
	L2	3.3±0.5	3.5±0.3	5.0 ±0,-0.5	2.4±0.3	6.7±0.5	7.0±0.5	2.25±0.25	3.25±0.25
	Process number	X	W	V	7	C	A	4(Don't cut the foot)	T
	L1	2.5±0.5	2.0±0.5	1.0±0.5	2.0±0.5	<1.6(containϕd)	2.5±0.3	4.0±0.5	<2.0
	L2	5.8±0.5	2.5±0.5	3.5±0.3	3.2±0.4	2.0±0.5	3.7±0.3	15.5±0.5	9.3±0.5

O	Process number	1	2	5	8	B	G	H	M
	L1	2.0±0.3	1.±0.2	1.2±0.25	1.0±0.3	1.5±0.5	1.5±0.5	1.5±0.5	3.0±0.5
	L2	3.7±0.3	3.7±0.3	2.0±0.2	2.3±0.2	6.5±0.2	3.2±0.2	5.0±0.2	6.0±0.5

Z	Process number	3	C	I	U	4	6	7	8
	L1	2.0+0/0.5	2.5±0.5	1.0±.2	1.2±.2	2.5±0.5	1.0±0.2	4.0±.5	2.5±0.3
	L2	3.85±0.25	4.6±.5	3.0±.2	2.8±.3	3.85±0.25	3.80±0.2	3.4±0.5	3.5±.3

Note: if the above size can not satisfied your need please contact us.

Available Terminals For SNAP-IN Type :

<p>Standard product code: S1G(the NO.13 code is G)</p> <p>apply to size $\Phi 22\sim 35$</p>	<p>Standard product code: S1A(the NO.13 code is A)</p> <p>apply to size $\Phi 22\sim 35$</p>
<p>Code: LL</p> <p>apply to size $\Phi 25\sim 35$</p>	<p>Three terminal code: L3</p> <p>apply to size $\Phi 25\sim 35$</p>
<p>Horizontal code: V*</p> <p>apply to size $\Phi 22\sim 35$</p>	<p>Four terminal code: L4</p> <p>apply to size $\Phi 35\sim 45$</p>
<p>代码: LT</p> <p>apply to size $\Phi 22\sim 35$</p>	<p>代码: LC</p> <p>apply to size $\Phi 35\sim 45$</p>

Available Terminals For Screw Type :

Standard product code: A1

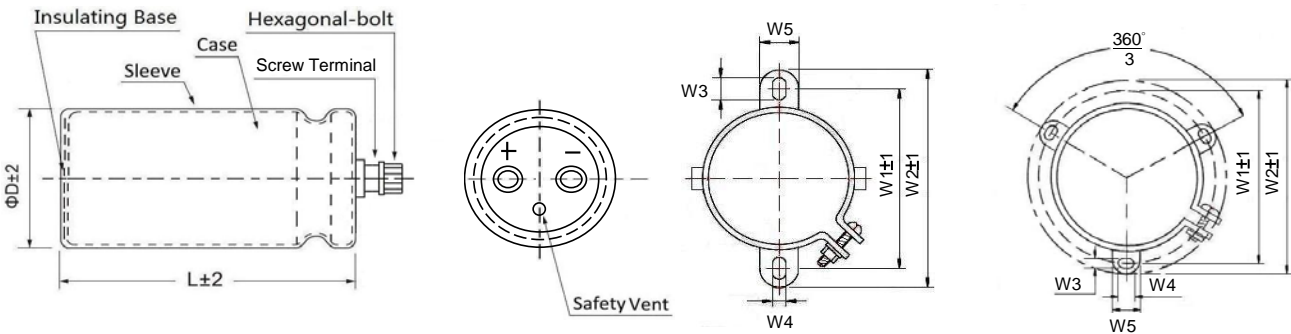

ΦD	W1	W2	W3	W4	W5
35	48.0	58.0	6.0	3.5	10
51	63.5	73.0	5.0	7.0	14
64	76.2	85.1	5.0	7.0	14
77	88.9	98.4	5.0	7.0	14
90	101.6	111.1	5.0	7.0	14

Packaging Specification

1.SMD Packing Specification

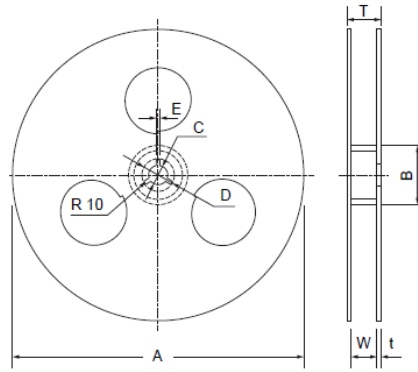

Size Unit : mm

Size	A	B	C	D	E	W	T	t
4Φ ~ 5Φ	380±2	84min	13.0±0.5	42	2.0±0.5	14±1	18±1	2.0
6.3Φ ~ 8×6.7	380±2	84min	13.0±0.5	42	2.0±0.5	18±1	22±1	2.0
8×10.2 ~ 10Φ	380±2	84min	13.0±0.5	42	2.0±0.5	26±1	30±1	2.0
12.5Φ	380±2	84min	13.0±0.5	42	2.0±0.5	32±1	36±1	2.0
16.0Φ	380±2	84min	13.0±0.5	42	2.0±0.5	44±1	48±1	2.0

① Reel Tape

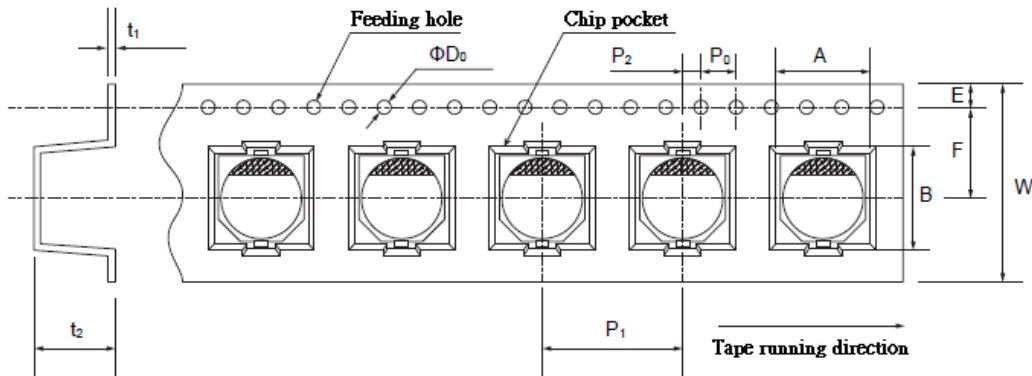

Size Unit : mm

Symbol SizeDxL	W	A	B	P ₀ ±0.1	P ₁	P ₂ ±0.1	F	ΦD ₀	t ₁	E	t ₂
4x5.4	12.0	4.7	4.7	4.0	8.0	2.0	5.5	1.5+0.1-0	0.4	1.75	5.8
5x5.4(5.8*)	12.0	5.7	5.7	4.0	12.0	2.0	5.5	1.5+0.1-0	0.4	1.75	5.8
6.3x5.4(5.8*)	16.0	7.0	7.0	4.0	12.0	2.0	7.5	1.5+0.1-0	0.4	1.75	5.8
6.3x7.7*	16.0	7.0	7.0	4.0	12.0	2.0	7.5	1.5+0.1-0	0.4	1.75	8.3
8x6.2	16.0	8.7	8.7	4.0	12.0	2.0	7.5	1.5+0.1-0	0.4	1.75	6.8
8x10.2(10.4*)	24.0	8.7	8.7	4.0	16.0	2.0	11.5	1.5+0.1-0	0.4	1.75	11.0
10x10.2*(12.2*)	24.0	10.7	10.7	4.0	16.0	2.0	11.5	1.5+0.1-0	0.4	1.75	11.0
12.5x13.5	32.0	13.4	13.4	4.0	24.0	2.0	14.2	1.5+0.1-0	0.4	1.75	14.0
12.5x16.0	32.0	13.4	13.4	4.0	24.0	2.0	14.2	1.5+0.1-0	0.4	1.75	16.2
16.0x16.5	44.0	17.5	17.5	4.0	28.0	2.0	20.2	1.5+0.1-0	0.4	1.75	16.7

② Packaging Specification

Size DxL(mm)	Q'ty per (pcs)	Inner box (pcs)	Measurement (mm)	gross (kg)	Outer carton (pcs)	Measurement (mm)	gross (kg)
4x5.4	2000	20,000	390x195x395	4	40,000	420x410x414	9
5x5.4(5.8*)	1000	10,000	390x195x395	5	20,000	420x410x414	11
6.3x5.4(5.8*)	1000	10,000	390x235x405	5	20,000	420x410x492	12
6.3x7.7*	1000	10,000	390x235x405	7	20,000	420x410x492	14
8x6.2	1000	10,000	390x235x405	7	20,000	420x410x492	15
8x10.2(10.4*)	500	4,000	390x255x405	6	8,000	420x410x530	13
10x10.2*(12.2*)	500	4,000	390x255x405	8	8,000	420x410x530	17
12.5x13.5	200	1,200	390x255x405	5	2,400	420x410x530	13
12.5x16.0	150	900	390x255x405	5	1,800	420x410x530	13
16.0x16.5	125	625	390x255x405	5	1,250	420x410x530	13

Note: product size don't marked with "*" mark is an applicable polymer solid aluminum electrolytic capacitor.

More detailed information please contact our company.

Packaging Specification

2. Conductive Polymer Aluminum Solid Capacitors

① Bulk package : Standard

Classification		Standard		
size ΦDxL(mm)	Vinyl bag Qty (pcs)	Inner box (pcs)	Outer carton (pcs)	gross weight (kg)
5×7.5×9,6.3×5.4	2,000	16,000	32,000	11
5.5×9,6.3×6.3×8	1,000	12,000	24,000	10
6.3×10.5	1,000	10,000	20,000	14
8×8,8×9,8×11.5	500	7,500	15,000	17
10×12.5	200	4,000	8,000	15

② Bulk package : Cutting & Forming

Classification		Cutting & Forming		
size ΦDxL(mm)	Vinyl bag Qty (pcs)	Inner box (pcs)	Outer carton (pcs)	gross weight (kg)
5×7.5×9,6.3×5.4	2,000	10,000	40,000	16
5.5×9,6.3×6.3×8	2,000	10,000	40,000	15
6.3×10.5	1,000	7,000	28,000	17
8×8,8×9	500	4,000	16,000	18
8×11.5	500	4,000	16,000	18
10×12.5	200	2,000	8,000	15

③ Ammo Tape (Fig.1)

Classification		Ammo Tape		gross weight (kg)
size ΦDxL(mm)	Outer carton (pcs)	Outer carton (pcs)		
6.3Φ	2,000	10,000	8	
8Φ×5-16L	1,000	5,000	7	
10Φ×10~17L	600	3,000	7	

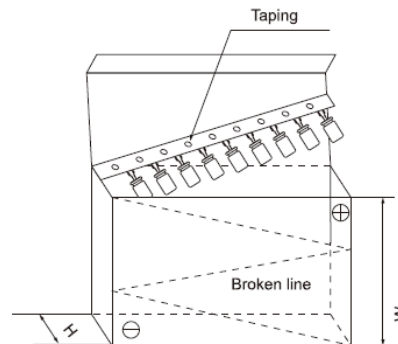

Fig.1

④ Reel Tape (Fig.2)

Classification		Roll Reel braid		gross weight (kg)
size ΦDxL(mm)	Inner box (pcs)	Outer carton (pcs)		
6.3Φ	2,000	10,000	6	
8Φ×5-16L	1,600	8,000	12	
10Φ×10~17L	1,000	5,000	14	

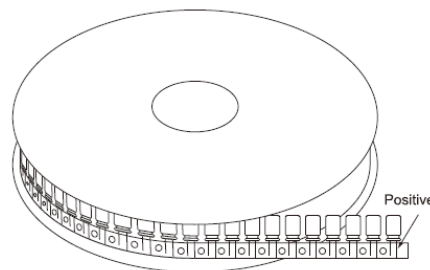

Fig.2

3. Radial Lead Type Aluminum Electrolytic Capacitors

① Bulk package : Standard

Standard					Standard				
size DxL(mm)	Vinyl bag Qty (pcs)	Inner box (pcs)	Outer carton (pcs)	gross weight (kg)	size DxL(mm)	Vinyl bag Qty (pcs)	Inner box (pcs)	Outer carton (pcs)	gross weight (kg)
4×5	2,000	24,000	48,000	13	10×14~10×15	200	3,600	7,200	15
4×7	2,000	20,000	40,000	12	10×16~10×18	200	3,600	7,200	15
5×5	2,000	20,000	40,000	11	10×20~10×21	200	3,000	6,000	16
5×7	2,000	16,000	32,000	14	10×22~10×25	200	2,400	4,800	16
5×9~5×11	1,000	12,000	24,000	11	10×26	200	2,400	4,800	17
5×15	1,000	10,000	20,000	13	10×27~10×35	200	1,800	3,600	16
6.3×5	2,000	16,000	32,000	13	12.5×13~12.5×16	100	2,400	4,800	15
6.3×7	2,000	12,000	24,000	11	12.5×20~12.5×22	100	1,800	3,600	15
6.3×9~6.3×14	1,000	10,000	20,000	14	12.5×23~12.5×26	100	1,200	2,400	13
6.3×15~6.3×17	1,000	10,000	20,000	14	12.5×30	100	1,200	2,400	15
8×5~8×7	500	10,000	20,000	14	13×13~13×16	100	2,400	4,800	15
8×9~8×12	500	7,500	15,000	16	13×18~13×21	100	1,800	3,600	16
8×14~8×15	500	5,000	10,000	13	13×24~13×26	100	1,200	2,400	12
8×16	500	5,000	10,000	14	13×30	100	1,200	2,400	13
8×20~8×25	200	4,000	8,000	14	13×35~13×36	100	1,000	2,000	14
10×9~10×13	200	4,000	8,000	14	13×38~13×40	100	800	1,600	13

② Bulk package : Cutting & Forming

Cutting & Forming					Cutting & Forming				
size ΦDxL(mm)	Vinyl bag Qty (pcs)	Inner box (pcs)	Outer carton (pcs)	gross weight (kg)	size ΦDxL(mm)	Vinyl bag Qty (pcs)	Inner box (pcs)	Outer carton (pcs)	gross weight (kg)
4×5	2,000	40,000	80,000	13	6.3×7	2,000	20,000	40,000	18
4×7	2,000	32,000	64,000	15	6.3×9~6.3×14	1,000	14,000	28,000	19
5×5	2,000	32,000	64,000	14	6.3×15~6.3×17	1,000	10,000	20,000	15
5×7	2,000	32,000	64,000	17	8×5~8×7	500	8,000	16,000	12
5×9~5×11	1,000	20,000	40,000	17	8×9~8×12	500	8,000	16,000	15
5×15	1,000	14,000	28,000	14	8×14~8×15	500	6,000	12,000	15
6.3×5	2,000	20,000	40,000	17	8×16	200	4,000	8,000	11

② Bulk package : Cutting & Forming

Classification		Cutting & Forming			Classification		Cutting & Forming		
size ΦDxL(mm)	Vinyl bag Qty (pcs)	Inner box (pcs)	Outer carton (pcs)	gross weight (kg)	size ΦDxL(mm)	Vinyl bag Qty (pcs)	Inner box (pcs)	Outer carton (pcs)	gross weight (kg)
8x20~8x25	200	4,000	8,000	13	12.5x23~12.5x26	200	1,200	2,400	12
10x9~10x13	200	4,000	8,000	13	12.5x30	100	1,000	2,000	11
10x14~10x15	200	4,000	8,000	15	13x13~13x16	200	1,600	3,200	11
10x16~10x18	200	3,200	6,400	14	13x18~13x21	200	1,200	2,400	11
10x20~10x21	200	2,800	5,600	13	13x24~13x26	200	1,200	2,400	11
10x22~10x25	200	2,400	4,800	15	13x30	100	1,000	2,000	13
10x26	200	1,600	3,200	13	13x35~13x36	100	600	1,200	9
10x27~10x35	200	1,600	3,200	14	13x38~13x40	100	600	1,200	12
12.5x13~12.5x16	200	1,600	3,200	11	16x15~16x20	200	1,000	2,000	14
12.5x20~12.5x22	200	1,200	2,400	10	18x15~18x20	200	1,000	2,000	17

③ For lattice bar type packing of standard& Cutting & Forming (Fig.3)

size		Standard		size		Cutting & Forming	
size ΦDxL(mm)	Inner box (pcs)	Outer carton (pcs)	gross weight (kg)	size ΦDxL(mm)	Inner box (pcs)	Outer carton (pcs)	gross weight (kg)
8φ×50~60L	1000	2000	10	8φ×30~45L	1000	4000	13
10φ×30~45L	700	2100	16	8φ×46~50L	1000	3000	14
10φ×46~60L	700	1400	13	10φ×30~45L	700	2800	15
12.5φ×35~45L	460	1380	12	10φ×46~60L	700	2100	16
12.5φ×50~60L	460	920	13	12.5φ×40~45L	460	1840	13
16φ×15~20L	300	1200	9	12.5φ×46~55L	460	1380	12
16φ×21~26L	300	900	8	16φ×21~30L	300	1200	13
16φ×27~32L	300	900	9	16φ×31~45L	300	1200	16
16φ×33~40L	300	900	14	18φ×21~30L	250	1000	13
16φ×45L	300	600	12	18φ×31~45L	250	1000	19
18φ×15~20L	250	1000	9	18φ×50L	250	750	16
18φ×21~45L	250	750	14	22φ×25~30L	160	640	11
18φ×50L	250	500	11	22φ×31~45L	160	640	16
22φ×25~45L	160	480	13	22φ×50L	160	480	13
22φ×50L	160	320	11				

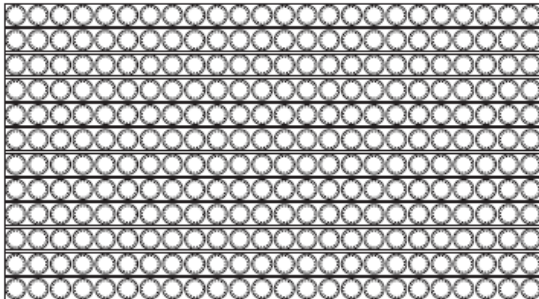

Fig.3

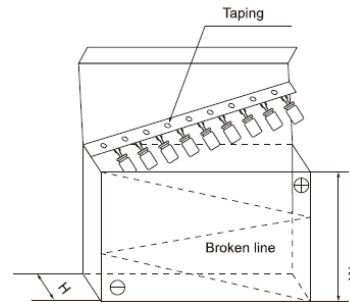

Fig.4

④ For Taping Ammo & Reel(Fig.4)

Classification		Ammo Tape					
size ΦDxL(mm)	Inner box (pcs)	Outer carton (pcs)	gross weight (kg)	size ΦDxL(mm)	Inner box (pcs)	Outer carton (pcs)	gross weight (kg)
4φ×5~7L	3000	15000	5	12.5φ×12.5~31L	500	2000	14
5φ×5~15L	2600	13000	8	13φ×13~31L	500	2000	14
6.3φ×5~17	2000	10000	8	12.5φ×35~41L	500	1500	12
8φ×5~17L	1200	6000	10	13φ×35~41L	500	1500	12
8φ×18~30L	1200	4800	13	16φ×15~32L	300	1200	14
10φ×9~17L	800	4000	10	16φ×35~40L	300	900	13
10φ×18~32L	800	3200	11	18φ×16~32L	250	1000	16
10φ×35L	800	2400	14	18φ×35~35.5L	250	750	14

⑤ Roll Reel braid(Fig.5)

Classification		Ammo Tape	
size ΦDxL(mm)	quantity (pcs/box)	quantity (pcs/box)	gross weight (kg/box)
4x5~7L	3,000	15,000	6
5x5~11L	2,400	12,000	8
6.3x5~11L	2,000	10,000	9
8x5~16L	1,600	8,000	12
8x20L	1,000	5,000	12
10x10~16L	1,200	6,000	13
10x17~20L	1,000	5,000	12

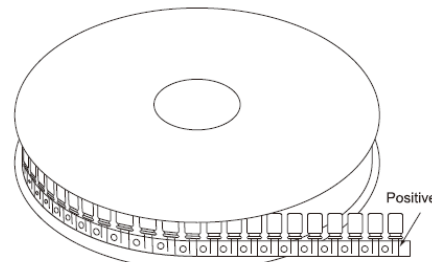

Fig.5

4. SNAP-IN Type Aluminum Electrolytic Capacitors(Fig.6)

size	weighe	inner box	outer carton
$\Phi D \times L(\text{mm})$	(g/pcs)	(pcs)	(pcs)
22x25 ~ 30	20 ~ 25	100	800
22x35 ~ 50	25 ~ 30	100	600
25x25 ~ 30	25 ~ 30	100	800
25x35 ~ 50	30 ~ 35	100	600
25x55 ~ 70	38.5 ~ 62	100	400
30x20 ~ 30	30 ~ 35	50	400
30x35 ~ 50	35 ~ 40	50	300
30 x 55~70	45~50	50	200
35x25 ~ 30	40 ~ 45	40	320
35x35 ~ 50	45 ~ 50	40	240
35x55 ~ 70	55~70	40	160

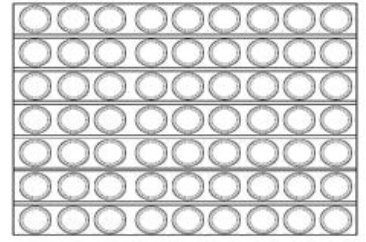

Fig.6

5. SCREW Type Aluminum Electrolytic Capacitors(Fig.7)

size	outer carton
$\Phi D \times L(\text{mm})$	(pcs)
35x50~100	42
51x70~115	40
64x96~115	15
77x100~236	15
90*105~236	12

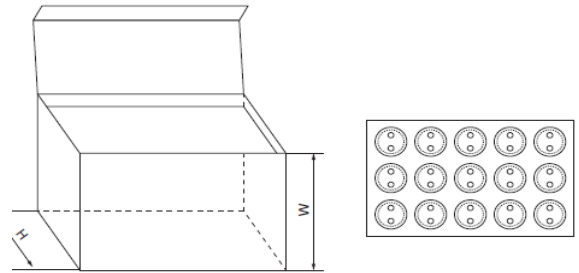

Fig.7

I .Lifetime Estimation

Subject series : FR/FH/FG/FF/FS/FL/FT/FP/VB/VP/VS

Conductive polymer aluminum solid capacitors are finite life electronic components like aluminum electrolytic capacitors. The lifetime is affected by ambient temperature, humidity, ripple current and surge voltage.

The lifetime of aluminum electrolytic capacitors is affected mainly by the loss of electrolyte as the result of the liquid electrolyte evaporating through the rubber seal materials, resulting in capacitance drop and tanδ rise. On the other hand, the lifetime of conductive polymer aluminum solid capacitors is affected mainly by oxidation degradation of the conductive polymer caused by osmose of oxygen or the thermal degradation of the conductive polymer by ambient temperature or self-heating, resulting in ESR rise and tanδ rise. The infiltration rate of the oxygen is depend on the temperature as the liquid electrolyte evaporation and the relationship follows the Arrhenius's Law, too. Similarly, thermal degradation of the conductive polymer by self-heating follows the Arrhenius's Law, too. Therefore, the lifetime estimation has been using the theory of lifetime increasing by 10 times at every 20°C reducing of the ambient temperature.

1. Lifetime Estimation

Equation (1) can be used for estimating the lifetime of the conductive polymer aluminum solid capacitors based on the ambient temperature and the rise of internal temperature due to ripple current.

$$L_x = L_0 \times 10^{(T_0 - T_x) / 20} \text{-----(1)}$$

- Lx : Estimation of actual lifetime (hour)
- Lo : Specified lifetime with the rated voltage at the upper limit of the category temperature (hour)
- To : Maximum category temperature (°C)
- Tx : Actual ambient temperature of the capacitor (°C)

Longer lifetime is expected by lowering the ripple current and the ambient temperature.
Please consult us about lifetime equations for the series of the category temperature 125°C.
Subject series : FT

An approximate value of ripple current-caused ΔT can be calculated using Equation (2)

$$\Delta T = \Delta T_0 \times (I_x / I_0)^2 \text{-----(2)}$$

- ΔTo : Rise in internal temperature due to the rated ripple current (20°C) The product that the maximum category temperature is less than 105°C
 - Ix : Operating ripple current (Arms) actually flowing in the capacitor
 - I0 : Rated ripple current (Arms), frequency compensated, at the upper limit of the category temperature range
- Please contact us about the product that the maximum category temperature is more than 125°C.
To determine more accurate values of ΔT, they can be actually measured using a thermocouple.

2. Rated Ripple Current Frequency Multipliers

Self-heat rise is generated by the ripple current even though the conductive polymer aluminum solid capacitors have low ESR compared to liquid based electrolyte aluminum electrolytic capacitor. Longer lifetime is expected by lowering the ripple current and the ambient temperature. Table 1 shows Frequency Multipliers of Rated ripple current.

Frequency Multipliers

Frequency [Hz]	120	1k	10k	50k	100k~500k
SMD type	0.05	0.3	0.55	0.7	1
Radial lead type	0.1	0.35	0.6	0.8	1

Conductive polymer aluminum solid capacitors have super low ESR characteristic in high-frequency range. On the whole, ESR in low-frequency range relatively rises. Therefore, they can use only l ripple current in low-frequency range.

3. Restriction of calculated lifetime

- (1) The result calculated by the estimated lifetime formula, it is not guaranteed lifetime by Nippon Chemi-Con Corporation.
- (2) When designer calculate the lifetime of apparatus, please include an ample margin in consideration to the estimated lifetime of a capacitor.
- (3) When calculated lifetime result are over 15 years by using the estimated lifetime formula, please consider 15 years to be a maximum in considering that the sealing rubber characteristics vary during the lifetime.
- (4) If 15 years or more may be required as an expected lifetime, please consult us.

II . About failure and shelf-life

Failure rate(failure rate level) subject to 0.5 %/1000 h of JIS C 5003 (Credibility level 60 %)
The main failure mode of polymer solid aluminum electrolytic capacitor of is shown below.

1. Random failure

The main cause of failure mold is short-circuit due to heat stress, electrical stressing and mechanical stress in using environment or welding.

- (1) applied voltage more than rated voltage
- (2) applied reverse voltage
- (3) Excessive mechanical stress
- (4) Applying fast charging and discharging that more than specifications and cause surge current

a.If the short circuit current flows through the solid capacitor will cause the following phenomenon.

- (1) When the electric current is less after short-circuit (φ10 : about below 1 A , φ8 : about below 0.5 A , φ6.3 : about below 0.2 A) PC-CON body will have little heat but appearance is normal even continuous electricity.

The Proper Usage Method of Conductive Polymer Solid Aluminum Electrolytic Capacitor

(2) When the short circuit current value exceeds the above numerical, internal temperature will increased, encapsulation adhesive pad summoned and the odorous gases to overflow.

b. In order to ensure the safety in case of occurs short circuit, please take the following countermeasures

- (1) Cut off the main power supply and stop using immediately if overflow the odorous gases.
- (2) Due to the different conditions , the odorous gases occurrence generally takes a few seconds to several minutes, When using protection circuits we recommend to start protect function in this period.
- (3) Cleaned immediately if the gas enters into eye , gargle immediately if inhalation into mouth.
- (4) Don't lick the electrolyte if electrolyte contact with the skin please washing with soap immediately.
- (5) PC - CON including combustibile material, current value greatly after the short circuit and short circuit parts will have a possibility of spark. In order to protect safety, please pay attention to the design structure and use protection circuit.

2. The wear failure (Shelf life)

Electrical characteristics can make a big change when more than the guarantee time of durability and high temperature and high humidity test, electrolyte will insulation (degradation) formation of open mode eventually.

Even used within the prescribed scope of electrical and mechanical properties, it may also reducing capacitance and increase ESR, so please take care when design.

III .Leak Current

The leak current of conductive polymer solid aluminum electrolytic capacitor will increase due to the mechanical stress .

In this case, if the solid capacitor apply voltage below the high using temperature, the repairing effect of leak current will reducing gradually.

If the solid capacitor applies rated voltage within the high using temperature, the repairing speed of leak current will faster.

Conductive polymer solid aluminum electrolytic capacitor
Repiring character of leak current
10μF/16 V.DC (apply 16 V.DC)

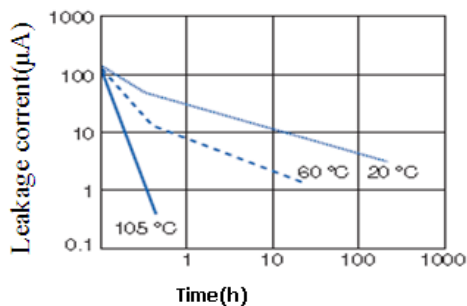

Conductive polymer solid aluminum electrolytic capacitor
Repiring character of leak current
33μF/10 V.DC (ambient temperature65°C)
(Test voltage10V.DC)

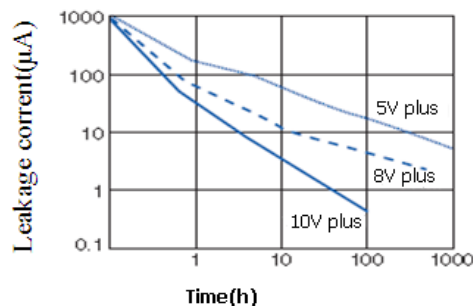

※In order to show more clearly said repair of leakage current , we use the sample of apply stress to PC-CON that increased leak current on purple

IV.The limited of faster charging and discharging

Faster charging and discharging will lead to large surge current and then result in short-circuit or increase leak current.

When the surge current value as below, we recommend to use protection circuit in order to maintain high reliability.

- (1) more than 10 A
- (2) exceed rated ripple current 10times

V. Correct mounting

1. About the soldering iron soldering

- (a)Avoiding applying stress on PC - CON body when it need to process lead due to unconformity between lead gap and circuit board gap of plug-in mounting.
- (b)Avoiding applying excessive stress on PC - CON body when soldering.
- (c) When need to take out PC-CON after soldering, please melt molten solder sufficient, implement under the condition of not put stress on the PC - CON body.
- (d) Don't let the tip of the soldering iron to touch the PC - CON body.

2. Wave-soldering

- (a) Do not have wave soldering to SMD product.
- (b) Do not dip the PC-CON body into dissolved soldering flux.
- (c) Welding parts only limited between the circuit board and the opposite side of the PC - CON.
- (d) Don't splash other place expectation rosin.
- (e)Avoiding other parts lie down and touching PC-CON when soldering.

3. Reflow soldering

- (a) Do not have reflow soldering to plug-in mounting product .
- (b) Please consult us when use VPS for soldering.

The Proper Usage Method of Conductive Polymer Solid Aluminum Electrolytic Capacitor

4. Precaution after soldering

Take care for not to apply the following excessive stress for polymer solid aluminum electrolytic capacitor.

- (a) Do not tilt down or distorted capacitor.
- (b) Mobile circuit board can not handle PC - CON.
- (c) Do not crash PC-CON.
- (d) Do not make the PC - CON touch PCB circuit boards and other components when stacked.

5. Recommended conditions for solder

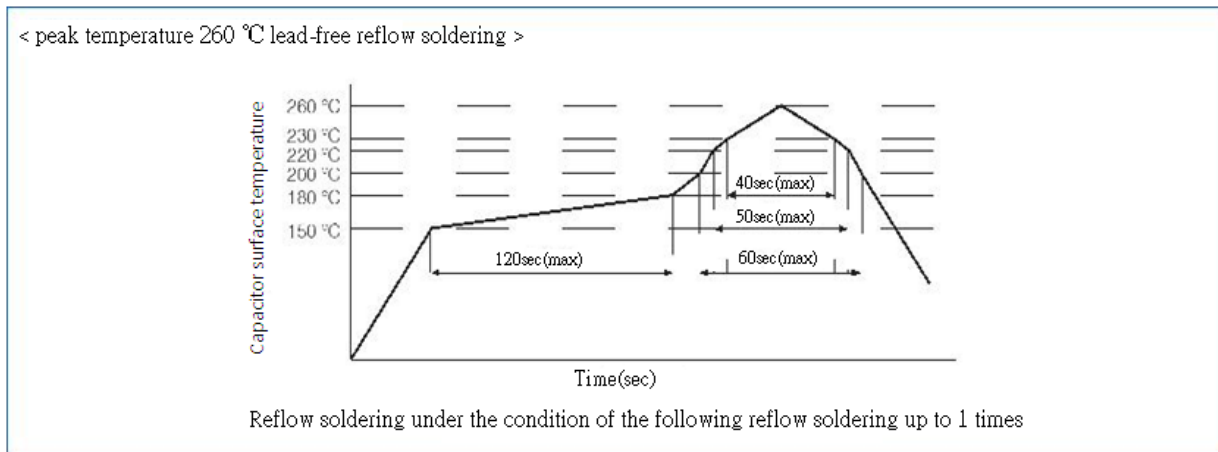
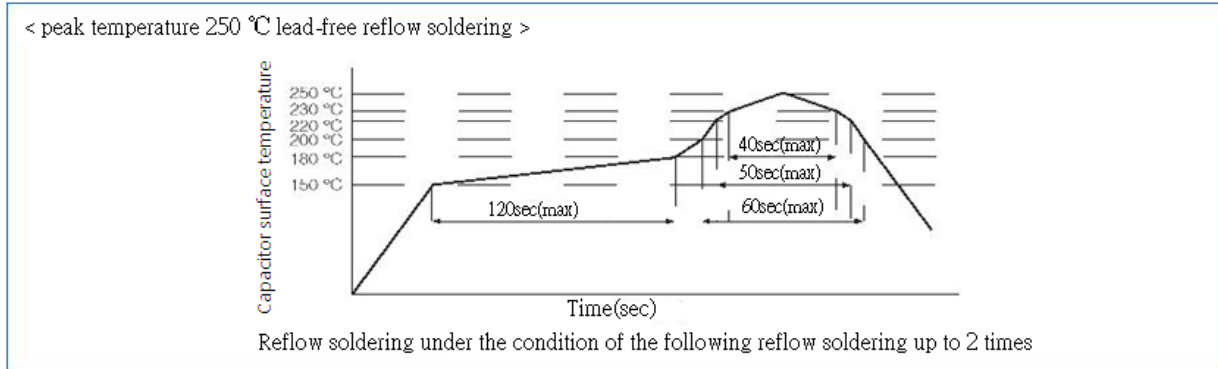

6. Solder iron temperature : less than 400°C±10°C ; working hours : within 5s

Wave-soldering

	Temperature	Time	Number of Time
Preheat	120°C below (ambient temperature)	less than 120s	once
Welding Condition	260°C+ 5°C below	less than 10+ 1s	less than twice*1

*1 : For 2 times, solder dipping time total of 10 + 1 seconds.

7. Recommend the bonding pad size

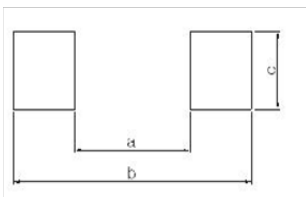

Unit : mm

Size Code	a	b	c
φ5.0	1.4	7.4	1.6
φ6.3	2.1	9.1	1.6
φ8.0	2.8	11.1	1.9
φ10.0	4.3	13.1	1.9

Precautions For Conductive Polymer Solid Aluminum Electrolytic Capacitor

I .Device circuits design considerations

1.Prohibited to use circuit

Conductive Polymer Solid Aluminum Electrolytic Capacitor (The following is called capacitor) may cause the leak current occur changing due to the heat stress in welding. Please avoid to use in the below circuit.

- ① High resistance voltage holding circuit.
- ② Coupled circuits.
- ③ The other circuits that affected leakage current larger

2.Circuit design

Please design circuit on the basis of confirming the following content.

- ① As the change of temperature and frequency, electric property of capacitor will changes.Please design circuit after confirming those changes.
- ② When more than 2 capacitors in parallel , please consider the balance of current when design circuit.
- ③ When more than 2 capacitors in series , as the difference of load voltage , it may load overvoltage, so please consulting us when using.
- ④ Please don't install heating components around the capacitor and the back of the printed wiring board.

3.Using capacitors for significantly safety-oriented applications

Consult us about capacitors for a device application affecting human safety (①Aviation and aerospace ②Nuclear ③Medical) or for any device whose failure will make an impact on society.

4.Polarity

Our company conductive polymer capacitor is the solid aluminum electrolytic capacitor with polarity. Never apply a reverse voltage or AC voltage. Connecting with wrong polarity will short-circuit in initial State. About polarity, please confirm product catalogue or the diagram in the product specifications.

5.Operating voltage

Do not apply an over-voltage that exceeds rated voltage. Because even if to load the voltage that more than the rated voltage only for an instant , it can also lead to increased leakage current and short-circuit. The total peak value of the ripple voltage plus the DC voltage must not exceed the rated voltage of the capacitors. In the work, it doesn't need to reduce the voltage. Although capacitors specify a surge voltage, in the temperature range, if under the rated voltage, whatever is the environment temperature; it also has limited and does not assure long-term use.

6.Ripple current

Do not apply an overcurrent that exceeds the rated ripple current specified for the capacitors. Excessive ripple current will increase heat production within the capacitors, shortening the life and short-circuit.

7.Operating temperature

If use beyond working temperature range of environment, can lead to aging and failure performance, please use in working temperature range.

8.Charging and discharging

Don not use capacitor in the circuit of rapid charge and discharge repeatedly. If capacitors are used in the circuits that repeat a charge and discharge, capacitance will decrease and/or the capacitors will be damaged by internal heat generation. When the peak of current value more that 20A, we recommend to use protect circuit in order to keep the reliability.

9.Leakage current

Sometime the leakage current will increase , but if load voltage in working temperature, it will decrease gradually though self-healing effect. In addition, the more closely to the limit temperature, the faster of the reduce speed of leakage current. The reasons for leakage current increase as below :

- ① Welding
- ② High temperature without load, high temperature and high humidity, rapid temperature change test and so on.

10.Failure mode

- ① Reduce the failure rate by reducing the surrounding temperature, ripple current and load voltage.
- ② Electrostatic capacity decreases caused by product temperature rise and opening mode wear caused by ESR rise, which are the main failure mode. Sometimes it will occur short-circuit mode due to the overvoltage and large current.
- ③ Lead to short-circuit due to load the voltage that more than rated voltage, when the current is larger, the shell will expansion or peeling off, give out bad smell due to the internal pressure rising.
- ④ The constitute material of products containing flammable materials , the short-circuit parts will fire may due to the spark. The install ways , location , graphic design of the product, please consider the following importance points of design to ensure the absolute safety.

* Setting up protection circuit and protection devices to ensure that equipment safety.

* Setting up long circuit etc . , so that the devices will stabilization even of a single fault.

11.The insulation of the capacitor

The outer sleeve of a capacitor does not assure electrical insulation Please have electrical insulation between the capacitor sleeve and cathode terminal and anode terminal and circuit board.

12.Operating conditions

Do not use/expose capacitors to the following conditions:

- ① Direct contact with water, salt water or oil, or high condensation environment.
- ② Direct sunlight.
- ③ Toxic gases such as hydrogen sulfide, sulfurous acid, nitrous acid, chlorine and its compounds, bromine and its compounds and ammonium.
- ④ Ozone, ultraviolet rays or radiation.
- ⑤ Extreme vibration or mechanical shock that exceeds limits in the catalogs or product specifications.

13. Capacitor Mounting

- ① SMD product (mould SMD 、 SMD) solder graphics of the Capacitor printed wiring board, Please refer to the provisions of the catalogue or specifications for graphic design.
- ② For radial lead type capacitors, please make sure the terminal spacing of a capacitor equals the holes spacing on the PC board.
- ③ Do not print any copper trace under the seal (terminal) side of a capacitor. Copper traces should be 1 mm (preferably 2mm or more) spaced apart from the side of the capacitor body.
- ④ In designing a double-sided PC board, do not locate any through-hole via or unnecessary hole underneath a capacitor.
- ⑤ In designing a double-sided PC board, do not print any circuit pattern underneath a capacitor.

II . Installation

1.Assembling

- ① Do not try to reuse the capacitors once assembled and electrically.

Precautions For Conductive Polymer Solid Aluminum Electrolytic Capacitor

② Capacitors may have been spontaneously recharged with time by a recovery voltage phenomenon. In this case, discharge the capacitors through a resistor of approximately 1kΩ before use.

③ If non-solid aluminum electrolytic capacitors have been stored at any conditions more than 35°C and 75%RH for long storage periods of time more than the limits specified in the catalogs or product specifications, they may have high leakage current. In this case, discharge by apply-ing the rated voltage through a resistor of approximately 1kΩ.

④ Confirm the rated capacitance and voltage of capacitors before installation.

⑤ Confirm the polarity of capacitors before installation.

⑥ Do not try to use the capacitors that were dropped to the floor and so forth.

⑦ Do not deform the can case of a capacitor.

⑧ Make sure that the terminal spacing of a capacitor equals the holes spacing on the PC board before installing the capacitor.

⑨ Do not apply excessive mechanical force to capacitors more than the limits prescribed in the catalogs or product specifications. If apply excessive force, the terminal will break off or deformation and affect install, even cause short-circuit, break line, increase LC and damage package. Avoid excessive mechanical force while the capacitors are in the process of vacuum-picking, placing and positioning by automatic mounting machines or cutting the lead wires by automatic insertion machines.

2. Soldering and heat resistance

Ensure that the soldering conditions meet the specifications recommended by Nippon Chemi-Con. Note that the leakage current may increase or capacitance may decrease due to thermal stresses that occur during soldering, etc. Furthermore, the leakage current which rose gradually decreases, when voltage is applied at below the category upper limit temperature. Additionally the self repairing action is faster when voltage near the rated voltage rather than at a higher voltage is applied at below the category's upper temperature limit.

1) Verify the following before using a soldering iron:

① That the soldering conditions (temperature and time) are within the ranges specified in the catalog or product specifications.

② That the tip of the soldering iron does not come into contact with the capacitor itself.

2) Verify the following when flow soldering:

① Do not dip the body of a capacitor into the solder bath only dip the terminals in. The soldering must be done on the reverse side of PC board.

② Soldering conditions should be within the limits prescribed in the catalog or the product specifications.

③ Do not apply flux to any part of capacitors other than their terminals.

④ Make sure the capacitors do not come into contact with any other components while soldering.

Please note the SMD product (SMD type) non-corresponding wave-soldering.

3) Verify the following when reflow soldering:

① Soldering conditions (preheat, solder temperature and soldering time) should be within the limits prescribed in the catalogs or the product specification.

② The heat level should be appropriate. (Note that the thermal stress on the capacitor varies depending on the type and position of the heater in the reflow oven, and the color and material of the capacitor.)

Except for the surface mount type, reflow soldering must not be used for the other capacitors.

4) Do not reuse a capacitor that has already been soldered to PC board and then removed. When using a new capacitor in the same location, remove the flux, etc. first, and then use a soldering iron to solder on the new capacitor in accordance with the specifications.

3. Handling After Soldering

Do not apply any mechanical stress to the capacitor after soldering onto the PC board. □

① Do not lean or twist the body of the capacitor after soldering the capacitors onto the PC board.

② Do not use the capacitors for lifting or carrying the assembly board.

③ Do not hit or poke the capacitor after soldering to PC board. When stacking the assembly board, be careful that other components do not touch the aluminum electrolytic capacitors.

④ Do not drop the assembled board.

4. Cleaning PC boards

1) Do not wash capacitors by using the following cleaning agents. Solvent resistant capacitors are only suitable for washing using the cleaning conditions prescribed in the catalog or the product specification. In particular, ultrasonic cleaning will accelerate damage to capacitors.

* Halogenated solvents → cause capacitors to fail due to corrosion.

* Alkali system solvents → corrode (dissolve) an aluminum case.

* Petroleum system solvents → cause the rubber seal material to deteriorate.

* Xylene → causes the rubber seal material to deteriorate

* Acetone → erases the markings

CFC alternatives or the other cleaners above; please consult with us.

2) Verify the following points when washing capacitors.

① Monitor conductivity, pH, specific gravity and the water content of cleaning agents. Contamination adversely affects these characteristics.

② Be sure not to expose the capacitors under solvent rich conditions or keep capacitors inside a closed container.

In addition, please dry the solvent sufficiently on the PC board and the capacitor with an air knife (temperature should be less than the maximum rated category temperature of the capacitor) for 10 minutes. Aluminum electrolytic capacitors can be characteristically and catastrophically damaged by halogen ions, particularly by chlorine ions, though the degree of the damage mainly depends upon the characteristics of the electrolyte and rubber seal material. When halogen ions come into contact with the capacitors, the foil corrodes when a voltage is applied. This corrosion causes an extremely high leakage current which results venting and an open circuit.

3) Verify the following when reflow soldering:

① Higher alcohol cleaning agents.

Using these cleaning agents, capacitors are capable of withstanding immersion or ultrasonic cleaning for 10 minutes at a maximum liquid temperature of 60°C. Find optimum condition for washing, rinsing, and drying. Be sure not to rub the marking off the capacitor which can be caused by contact with other components or the PC board. Note that shower cleaning adversely affects the markings on the sleeve.

② Non-Halogenated Solvent Cleaning.

Immersion, ultrasonic or vapor cleaning for 5 minutes. However, from an environmental point of view, these types of solvent will be banned in near future. We would recommend not using them if at all possible.

③ Isopropyl Alcohol (IPA).

IPA (Isopropyl Alcohol) is one of the most acceptable cleaning agents; it is necessary to maintain a flux content in the cleaning liquid at a maximum limit of 2 Wt.%.)

Precautions For Conductive Polymer Solid Aluminum Electrolytic Capacitor

5.Precautions for using adhesives and coating materials

- 1) Do not use any adhesive and coating materials containing.
- 2) Verify the following before using adhesive and coating material.
 - ① Remove flux and dust left over between the rubber seal and the PC board before applying adhesive or coating materials to the capacitor.
 - ② Dry and remove any residual cleaning agents before applying adhesive and coating materials to the capacitors. Do not cover over the whole surface of the rubber seal with the adhesive or coating materials.
 - ③ For permissible heat conditions for curing adhesives or coating materials, please consult with us.
 - ④ Covering over the whole surface of the capacitor rubber seal with resin may result in a hazardous condition because the inside pressure cannot be completely released. Also, a large amount of halogen ions in resins will cause the capacitors to fail because the halogen ions penetrate into the rubber seal and the inside of the capacitor.
 - ⑤ Some coating materials, it cannot be implemented to the capacitor.

6. Fumigation

In many cases when exporting or importing electronic devices, such as capacitors, wooden packaging is used. In order to control insects it may become necessary to fumigate the shipment. Precautions during "Fumigation" using halogenated chemical such as Methyl Bromide must be taken. Halogen gas can penetrate packaging materials such as cardboard boxes and vinyl bags. Penetration of the halogenated gas can cause corrosion of Electrolytic capacitors. Nippon Chemi-Con gives consideration to the packaging materials not to require the Fumigation. Verify whether the assembled PC board, products and capacitors themselves are subjected to Fumigation during their transportation or not.

III.The Operation of Devices

1.Do not touch the capacitor terminals directly.

2.Do not short-circuit the terminal of a capacitor by letting it come into contact with any conductive object.

Also, do not spill electric-conductive liquid such as acid or alkaline solution over the capacitor.

3.Please make sure the assembly of the complete circuit of capacitor installation environment.

Do not use capacitors in circumstances where they would be subject to exposure to the following materials

- ① Oil, water, salty water or damp location.
- ② Direct sunlight.
- ③ Ozone, ultraviolet rays or radiation.
- ④ Toxic gases such as hydrogen sulfide, sulfurous acid, nitrous acid, chlorine or its compounds, and ammonium.
- ⑤ Severe vibration or mechanical shock conditions beyond the limits prescribed in the catalog or product specification.

IV.Maintenance Inspection

1.Make periodic inspections of capacitors that have been used in industrial applications.

Before inspection, turn off the power supply and carefully discharge the electricity in the capacitors. Verify the polarity when measuring the capacitors with a volt-ohm meter. Do not apply any mechanical stress to the terminals of the capacitors.

2.The following items should be checked during the periodic inspections.

- ① Significant damage in appearance.
- ② Electrical characteristics: leakage current, capacitance, $\tan\delta$ and other characteristics prescribed in the catalog or product specification.

We recommend replacing the capacitors if the parts are out of specification.

V.Contingencies

- 1) If gas has vented from the capacitor during use, there is a short circuit and burning, or the capacitor discharges an odor or smoke, turn off the main power supply to the equipment or unplug the power cord.
- 2) If there is a problem with the capacitor or a fire breaks out, the capacitor may produce a burning gas or reactive gas from the outer resin, etc. If this happens, keep your hands and face away from the gas. If vented gas is inhaled or comes into contact with your eyes, flush your eyes immediately with water and/or gargle. If vented gas comes into contact with the skin, wash the affected area thoroughly with soap and water.

VI.Storage

We recommend the following conditions for storage.

- 1) Store capacitors in a cool, dry place. Store at a temperature between 5 and 35°C, with a humidity of 75% or less.(table-1 Maximum storage term)

The duration, please refer to the table below.

	Before the bag is opened	After the bag is opened
SMD (Resin-Molded chip type	within six months after delivery	Within 30 days after the bag is opened
Radial lead type	within one year after delivery	Within 7 days after the bag is opened

- ① SMD products are sealed in a PE plastic bag. Use all capacitors in desposit period once the bag is opened.
 - ② If the bag have open and need to storage, please return unused capacitors to the bag, and seal it with a zipper.
 - ③ Be sure to follow our recommendations for reflow soldering.
- 2) Store the capacitors in a location free from direct contact with water, salt water, and oil.
 - 3) Store in a location where the capacitor is not exposed to toxic gas, such as hydrogen sulfide, sulfurous acid, nitrous acid, chlorine or chlorine compounds, bromine or other halogen gases, methyl bromide or other halogen compounds, ammonia, or similar.
 - 4) Store in a location where the capacitor is not exposed to ozone, ultraviolet radiation, or other radiation.
 - 5) It is recommended to store capacitors in their original packaging wherever possible.

VII.Disposal

Please consult with a local industrial waste disposal specialist when disposing of aluminum electrolytic capacitors.

VIII.Regarding compliance for EU REACH Regulation

- 1) According to the content of REACH handbook (Guidance on requirements for substances in articles which is published on May 2008), our electronic components are "articles without any intended release". Therefore they are not applicable for "Registration" for EU REACH Regulation Article 7 (1).

Reference: Electrolytic Condenser Investigation Society:"Study of REACH Regulation in EU about Electrolytic Capacitor" (publicized on 13 March 2008)

- 2) Nippon TEAPO develops the products without substance of very high concern(SVHC).

IX.Catalogs

Specifications in the catalogs are subject to change without notice. Test data shown in the catalogs are not assured as the whole performance values, but typical values.

1 . Overview of Aluminum Electrolytic Capacitors

1-1 Basic Model of Aluminum Electrolytic Capacitors

1) Capacitors are passive components. Among the various kinds of capacitors, aluminum electrolytic capacitors offer larger CV product per case size and lower cost than the others. In principles of capacitor, its fundamental model is shown in Fig.1 and its capacitance © is expressed by Equation (1) below:

$$C = 8.854 \times 10^{-12} \times \frac{\epsilon S}{d} (F) \dots\dots\dots (1)$$

- ε : Dielectric constant
- S : Surface area of dielectric (m²)
- d : Thickness of dielectric (m)

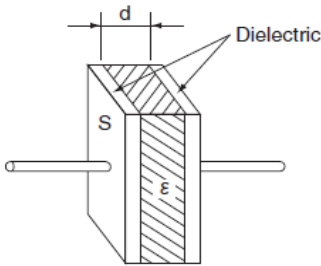

Fig-1 Basic model of capacitor

2) Equation (1) shows that the capacitance (C) increases as the dielectric constant (ε) and/or its surface area (S) increases and/or the dielectric thickness (d) decreases.

An aluminum electrolytic capacitor comprises a dielectric layer of aluminum oxide (Al₂O₃), the dielectric constant (ε) of which is 8 to 10. This value is not significantly larger than those of other types of capacitors

However, by extending the surface area (S) of the aluminum foil electrode by means of etching, and by electrochemically forming a thinner but highly voltage-withstandable layer of oxide layer dielectric, the aluminum electrolytic capacitor can offer a larger CV product per case than other types of capacitors.

3) A basic model of aluminum electrolytic capacitor is shown in Fig. 2.

An aluminum electrolytic capacitor comprises

- Anode ...Aluminum foil
- Dielectric...Electrochemically formed oxide layer (Al₂O₃) on the anode
- Cathode ...A true cathode is electrolytic solution (electrolyte).

Other component materials include a paper separator that holds electrolyte in place and another aluminum foil that functions as a draw-out electrode coming into contact with the true cathode (electrolyte). In general, an aluminum electrolytic capacitor is asymmetrical in structure and polarized. The other capacitor type known as a bi-polar (non-polar) comprises the anodic aluminum foils for both electrodes.

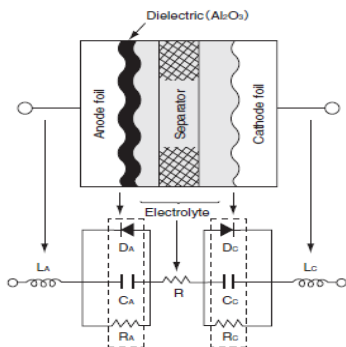

Fig-2 Basic model and equivalent circuit aluminum electrolytic capacitor

- CA, CC : Capacitance due to anode and cathodes foils
- DA, DC : Diode effects due to oxide layer on anode and cathode foils
- L , L : Inductance due to anode and cathode terminals
- R : Resistance of electrolyte and separator
- RA, RC : Internal resistance of oxide layer on anode and cathode foils.

1-2 Structure of Aluminum Electrolytic Capacitor

1) The aluminum electrolytic capacitor has, as shown in Fig. 3, a roll of anode foil, paper separator, cathode foil and electrode terminals (internal and external terminals) with the electrolyte impregnated, which is sealed in an aluminum can case with a sealing material. The terminal draw-out structure, sealing material and structure

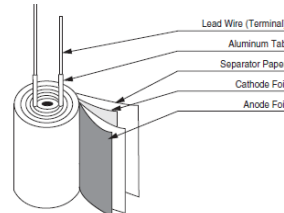

Fig-3 Basic model of element

2) The terminal draw-out structure, sealing material and structure differ depending on the type of the capacitor. Figure 4 shows typical examples.

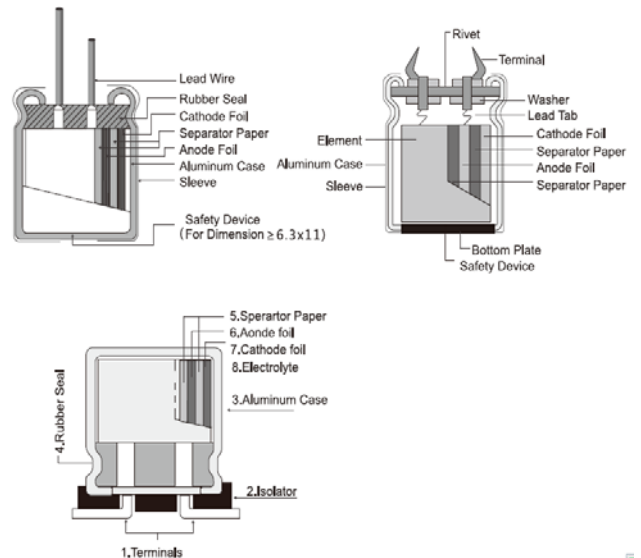

Fig-4 Construction of Aluminum Electrolytic Capacitors

1-3 Features of Capacitor Materials

Aluminum, which is main material in an aluminum electrolytic capacitor, forms an oxide layer (Al₂O₃) on its surface when the aluminum is set as anode and charged with electricity in electrolyte. The aluminum foil with an oxide layer formed thereon, as shown in Fig. 5, is capable of rectifying electric current in electrolyte. Such a metal is called a valve metal.

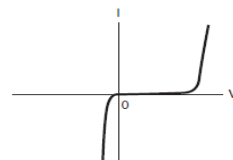

Fig-5 V-I characteristics of aluminum oxide

<Anode aluminum foil>

First, the foil material is electromechanically etched in a chloride solution to extend the surface area of the foil. Secondly, for the foil to form an aluminum oxide layer (Al_2O_3) as a dielectric, more than the rated voltage is applied to the foil in a solution such as ammonium borate. This dielectric layer is as dense and thin as 1.1 - 1.5 nm/volt and showing a high insulation resistance (108 - 109 Ω/m). The thickness of the oxide layer determines withstand voltage according to their direct proportional relationship. For the etching pits to be shaped to the intended thickness of the oxide, the pit patterns have been designed to have efficient surface area extension depending on the intended withstand voltage (see Fig. 6)

<Cathode aluminum foil>

An etching process is performed to the cathode aluminum foil as well as the anode foil. However, the formation process for oxide layer is generally not performed. Therefore, the surface of the cathode foil only has an oxide layer (Al_2O_3) that has spontaneously formed, which gives a withstand voltage of about 0.5 volt

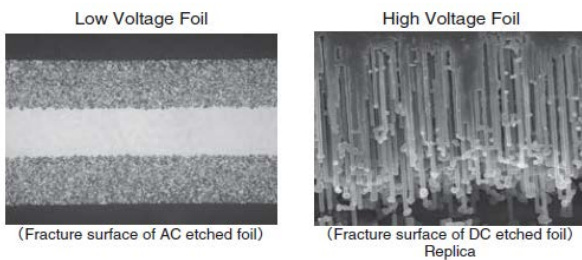

Fig-6 Cross section of aluminum etched foil (SEM)

<Electrolyte>

The electrolyte, an ion-conductive liquid functions as a true coming into contact with the dielectric layer on the surface of the foil. The cathode foil serves as a collector electrode to connect the cathode with the external circuit. Electrolyte is an essential controls the performance of the capacitor (temperature frequency characteristics, service life, etc.).

<Paper separator >

The separator maintains uniform distribution of the electrolyte and keeps the anode-to-cathode foil distance unchanged.

<Can case and sealing materials>

An aluminum can case and seal materials mainly consisting of rubber are used for the purpose of keeping airtightness.

1-4 Manufacturing Process

① Etching (for extending the surface area)

This etching process serves to extend the surface area of the foil. This is an AC or DC current-employed electrochemical process for etching the foil surface in a chloride solution (see Fig. 7)

② Formation (for forming a dielectric)

This is a process for forming a dielectric layer (Al_2O_3), which is normally performed on the anode aluminum foil. (see Fig. 8)

③ Slitting

This is a process for slitting aluminum foils (both the anode and cathode) and separator papers to the specified product size. (see Fig. 9)

④ Winding

This is a process for rolling a set of anode and cathode foils into a cylindrical form with a paper separator inserted between them. During this process, an inner terminal (called a tab) is attached to each of the aluminum foils. The roll made at this process is called a capacitor element.

⑤ Impregnation

This is a process for impregnating the element with electrolyte as a true cathode. The electrolyte also functions to repair the dielectric layer. (see Fig. 11)

⑥ Sealing

This process seals the element using the aluminum can case and sealing materials (rubber, rubber-lined cover, etc.) for keeping the case airtight. (see Fig. 12)

⑦ Aging (reforming)

The process of applying voltage to a post-sealed capacitor at high temperature is called "aging". This serves to repair defective dielectrics that have been made on the foil during the slitting or winding process.

⑧ 100% inspection and packaging

After the aging, all products shall undergo testing for checking their electrical characteristics with chip termination, lead reforming, taping etc. finished, and then be packaged.

⑨ Outgoing inspections

Outgoing inspections are performed as per standard inspection procedures.

⑩ Shipment

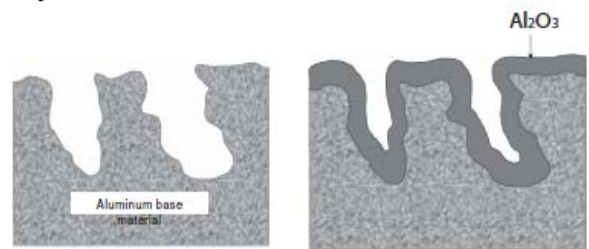

see Fig. 7 Etching Model

see Fig. 8 Forming Model



see Fig. 9 Slitting Model

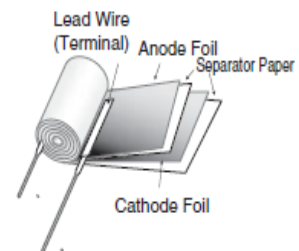

see Fig. 10 Cathode Foil

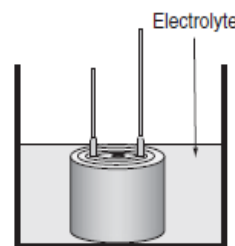

see Fig. 11 Impregnation

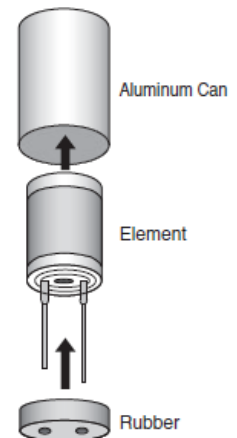

see Fig. 12

2 . Basic Performance

2-1 Basic Electrical Characteristics

2-1-1 Capacitance

The larger the surface area of an electrode is, the higher the capacitance (capacity for storing electricity) is. For aluminum electrolytic capacitors, capacitance is measured under the standard of 20°C and a 120Hz AC signal of about 0.5V. Generally, as the temperature rises, the capacitance increases; as the temperature decreases, the capacitance decreases (Fig. 13). With a higher frequency, the capacitance is smaller; with a lower frequency, the capacitance is larger (Fig.14).

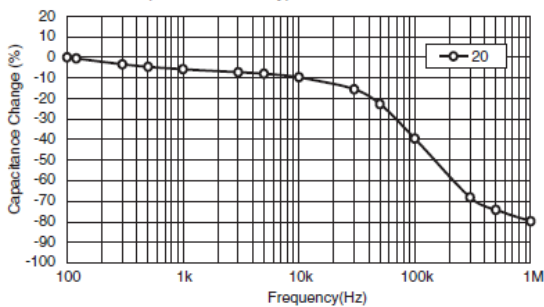
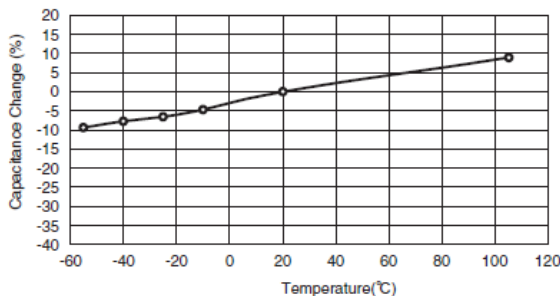

Fig-14 Frequency Characteristics of Capacitance

2-1-2 Tanδ (also called tangent of loss angle or dissipation factor)

(Fig. 15) is a simplified model of the equivalent circuit shown in (Fig. 15). For an ideal capacitor with an equivalent series resistance of R = 0, the tanδ shown in (Fig. 10) is zero. For an aluminum electrolytic capacitor, the equivalent series resistance (R) is not zero due to the presence of resistance of the electrolyte and paper separator and other contact resistances. 1/ωC and R are correlated as shown in (Fig. 16) and Equation (2).

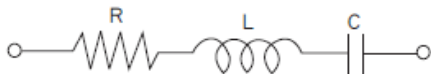

Fig-15 Simplified equivalent circuit

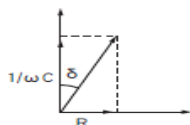

Fig-16 Dissipation Factor (tanδ)

$$\tan \delta = \frac{R}{1/\omega C} = \omega CR \dots\dots\dots (2)$$

ω : 2 π f

π = Circular constant, f : Frequency (f = 120Hz)

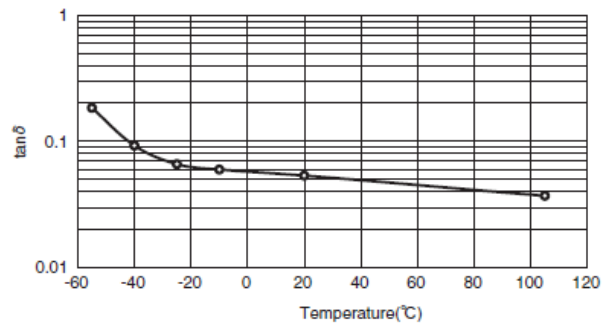

Fig-17 Temperature Characteristics of tanδ

2-1-3 Leakage Current (LC)

① As a feature of an aluminum electrolytic capacitor, when DC voltage is applied to it, the oxide layer that acts as a dielectric in the electrolyte allows a small amount of electric current to flow in it. The small amount

of current is called a leakage current (LC). An ideal capacitor does not allow the leakage current to flow (this is not the case for charging current).

② The leakage current (LC) changes with time as shown in (Fig. 18). value. Therefore, the specifications of LC are defined as a value of the rated voltage at 20°C. As the temperature rises, the LC increases; as the temperature decreases, the LC decreases (Fig.19). As the applied voltage decreases, the LC decreases.

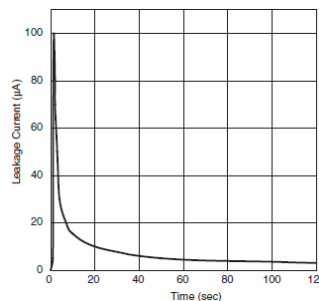

Fig-18 Leakage Current vs. Time

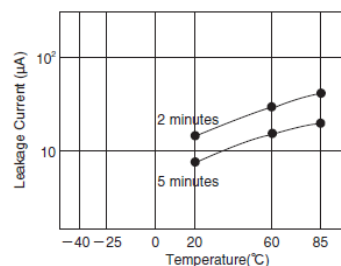

Fig-19 Temperature Characteristics of Leakage Current

2-2 Frequency Characteristics of Impedance (Z)

① When a capacitor is applied with a voltage with the frequency changed, the impedance (Z), a factor of preventing the AC current changes as shown in (Fig. 14). This is the impedance-frequency characteristics of the capacitor.

② (Fig. 15) is a simplified model of an equivalent circuit of an aluminum electrolyte capacitor. (Fig. 20) shows dotted lines representing a breakdown of the impedance-frequency characteristic curve into components (C, R and L). As can be seen in this figure, the impedance-frequency characteristics are a composition of C, R and L frequency characteristics.

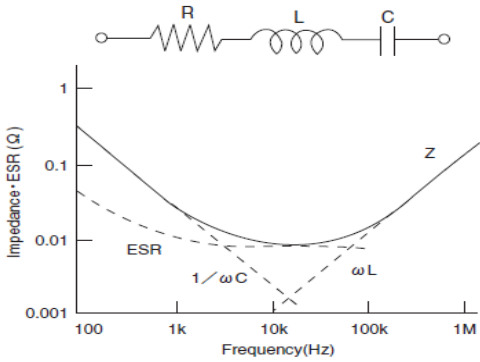

Fig-20 Factor of Impedance Frequency

③ The value $1/\omega C$ shows the pure capacitive reactance graphically presented by a straight line going downward at an angle of 45° , and ωL shows the pure inductive reactance graphically presented by a straight line going upward at 45° . R shows the equivalent series resistance (ESR). At a range of lower frequencies, the R curve goes downward due to the dielectric loss frequency-dependence. At a range of higher frequencies, the R curve tends to be almost flat since resistance of electrolyte and paper separator is dominant and independent on frequency. Equation (3) shows this tendency.

$$Z = \sqrt{R^2 + \left(\omega L - \frac{1}{\omega C}\right)^2} \dots\dots\dots (3)$$

④ Because the impedance characteristics of an aluminum electrolyte capacitor depend on resistance of the electrolyte and paper separator, the Z value at the self-resonant frequency tends to be shown by the solid line in (Fig.21). The resistance of the electrolyte varies depending on temperature: as the temperature rises, the impedance decreases; and as the temperature decreases, the impedance increases, as shown in (Fig. 22).

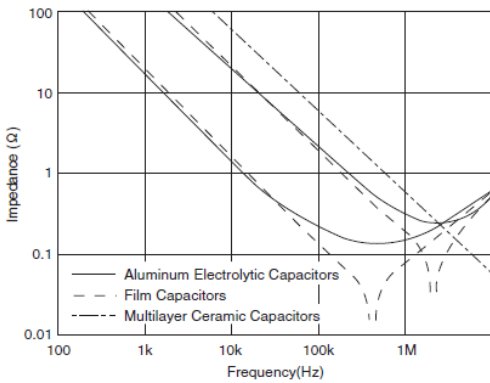

Fig-21 Frequency Characteristics of each Capacitors Impedance

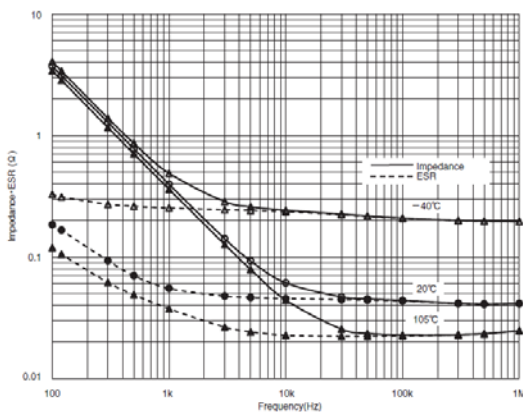

Fig-22 Temperature and Frequency Characteristics of Impedance · ESR

3 . Reliability

For designing the device with aluminum electrolytic capacitors, a failure rate and useful life are necessary to be considered for their reliability. The failure rate of aluminum electrolytic capacitors is approximated by the bathtub curve shown in (Fig.23).

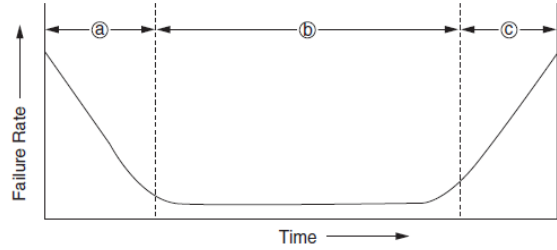

Fig-23 Bathtub curve

- a Early failure period
At the comparatively early periods of use, devices/components fail by deficiencies in design or manufacturing process or incompatibility with operation conditions. For aluminum electrolytic capacitors, these defectives are removed by debugging at one of manufacturing processes before shipments.
- b Random failure period
Failure is stable low in occurrence and appears unrelated to their served term. Aluminum electrolytic capacitors are low in failures in this period compared with semi-conductors and solid tantalum capacitors.
- c Wear-out failure period
In this period, the failure rate increases with the served time. For aluminum electrolytic capacitors, since they were completed in manufacturing, the electrolyte impregnated has gradually evaporated and diffused out of the capacitors through the rubber seal materials with time, which leads to decrease in the capacitance and/or increase in $\tan\delta$. When any of these values changes beyond the allowable range of specifications, the capacitors are defined as “fell into the wear-out failure”. The served term until the capacitors fall into the wear-out failure period is called a useful life.

4 . Failure Modes

Aluminum electrolytic capacitors have two categories of failures: catastrophic failure and wear-out failure.

<Catastrophic failure>

This is a failure mode that completely destroys the function of the capacitor such as short circuit and open circuit failure

<Wear-out failure>

This is a failure mode where the electrical parameters of the capacitor gradually deteriorate and fail. The criteria for determining if this failure has occurred depend on the purpose of a device.

For each series of capacitors, the following electrical parameters have been defined as criteria in the specifications of Endurance in the catalogs or product specifications:

- Change in capacitance
- $\tan\delta$
- Leakage current

① Failure rates are often measured in units of % per 1000 hours (10^{-5} /hour). For higher reliability devices designed with a smaller failure rate, units of Failure In Time (FIT) (10^{-9} /hour) is used.

② Aluminum electrolytic capacitors are considered as components of wear-out failure mode, the electrical characteristics of which gradually deteriorate and their failure rate increases with time. In general, the failure rate in FIT is determined by total component-

hours (product of the number of tested components and test hours).

③ Due to the definition of FIT, the same FIT rate can be calculated in both cases of testing on the large number of tested components and also testing for long test periods of time. However, these cases mean differently for aluminum electrolytic capacitors. Using the failure rate is not suited to express the reliability of aluminum electrolytic capacitors, but the electrical characteristics based lifetime in hour should be considered to express the reliability.

④ Also, there are MTBF (Mean Time Between Failures) and MTTF (Mean Time To Failure) to express reliability. The latter is applicable for aluminum electrolytic capacitors because they are categorized into a group of non-repairable systems, equipment and devices for which MTTF is applicable. Failure modes depend on the application conditions that lead to fail. (Fig. 24).

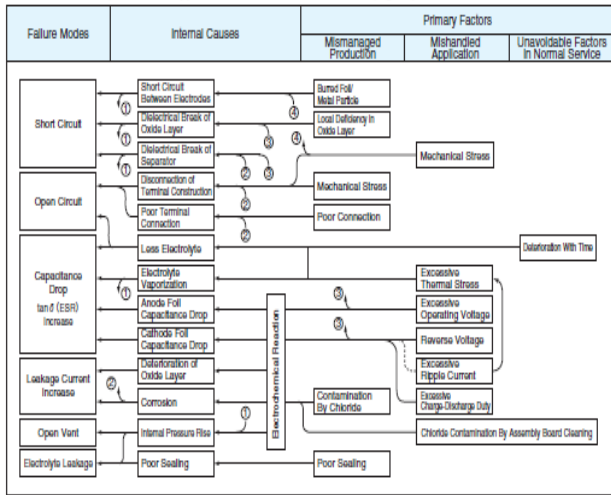

5. Circuit Design Fig-24 Failure Modes

1) Operating Temperature, Equivalent Series Resistance(ESR), Ripple Current and Load Life

★ MTTF(Mean-Time-TO-Failure) means the useful life at room temperature 25°C.

1-1 Load life:

If the capacitor's max. operating temperature is at 105°C(85°C), then after applying capacitor's rated voltage (WV) for L₀ hours at 105°C(85°C), the capacitor shall meet the requirements in detail specification. where L₀ is called "load life" or "useful life (lifetime) at 105°C(85°C)".

$$V_0 \leq 100WV : L_x = L_0 \times 2^{(T_0 - T_x)/10} \times 2^{-\Delta T_x / 5}$$

$$V_0 \geq 160WV : L_x = L_0 \times 2^{(T_0 - T_x)/10} \times 2^{-\Delta T_x / 5} \times (V_0 / V_x)^{4.4}$$

where $\Delta T_x = \Delta T_0 \times (I_x / I_0)^2$

1-2 Ripple life:

If the capacitor's max. operating temperature is at 105°C(85°C), then after applying capacitor's rated voltage (WV) with the ripple current for L_r hours at 105°C(85°C), the capacitor shall meet the requirements in detail specification. where L_r is called "ripple life" or "useful ripple life(ripple lifetime) at 105°C(85°C)".

$$V_0 \leq 100WV : L_x = L_r \times 2^{(T_0 - T_x)/10} \times 2^{(\Delta T_0 - \Delta T_x) / 5}$$

$$V_0 \geq 160WV : L_x = L_r \times 2^{(T_0 - T_x)/10} \times 2^{(\Delta T_0 - \Delta T_x) / 5} \times (V_0 / V_x)^{4.4}$$

where $\Delta T_x = \Delta T_0 \times (I_x / I_0)^2$

The (ripple) life expectancy at a lower temperature than the specified maximum temperature may be estimated by the following equation, but this expectancy formula does not apply for ambient below +40°C.

L₀= Expected life period (hrs) at maximum operating temperature allowed.

L_r= Expected ripple life period (hrs) at maximum operating temperature allowed

- L_x= Expected life period (hrs) at actual operating temperature
- T₀= Maximum operating temperature (°C) allowed
- T_x= Actual operating ambient temperature (°C)
- I_x= Actual applied ripple current (mA rms) at operating frequency f₀ (Hz)
- I₀= Rated maximum permissible ripple current IR(mA rms) x frequency multiplier (Cf) at f₀ (Hz)
- V₀=Rated voltage(V)
- V_x=Actual applied voltage(V)

※Ripple Current calculation: no need Temperature Multiplying Factor.

※For Ripple life , I_x and V_x Should be 80% equal or more of I₀ and V₀,if less than 80%, calculate with 80%.

ΔT₀ ≤ 5°C= Maximum temperature rise (°C) for applying I₀ (mA rms)

ΔT_c=Temperature rise (°C) of capacitor case for applying I_x (mA/rms)

ΔT_x= Temperature rise (°C) of capacitor element for applying I_x (mA rms) = K_cΔT_c = K_c(T_c - T_x)

where T_c is the surface temperature (°C) of capacitor case
T_x= is ditto.

K_c= is transfer coefficient between element and case of capacitor from table below :

Φ	≤8	10	12.5/13	16	18	22	25	30	35
K _c	1.10	1.15	1.20	1.25	1.30	1.35	1.40	1.50	1.65

※ The estimated life is limited to 15 years, if it exceeds 15 years, take 15 years as standard. If 15 years or more may be required as an excepted lifetime, please consult us.

★ The formula of Equivalent Series Resistance (ESR)

The operating frequency of ESR, DF, f & C must be the same, usually they test at 120 Hz. ESR=DF / 2πf C.....(2)

Where DF: Dissipation Factor(tanδ) f : Operating frequency(Hz)
C: Capacitance(F)

★ Estimation of life considering the ripple current

The ripple current affects the life of a capacitor because the internal loss (ESR) generates heat. The generated heat will be: P = I² R.....(3)

Where I : Ripple current(Arms.) R: ESR(Ω)

At this time the increase in the capacitor temperature will be:

$$\Delta T = I^2 R / AH.....(4)$$

Where ΔT: Temperature increase in the capacitor core(degree)

I : Ripple current(Arms) R: ESR(Ω)

A: Surface area of the capacitor (cm²)

H: Radiation coefficient(Approx. 1.5~2.0 · 10⁻³ W/ cm² · °C)

The above equation (4) shows that the temperature of a capacitor increases in proportion to the square of the applied ripple current and ESR, and in inverse proportion to the surface area. Therefore, the amount of the ripple current determines the heat generation, which affects the life. The values of ΔT varies depending on the capacitor types and operating conditions. The usage is generally desirable if ΔT remains less than 5°C. The measuring point for temperature increase due to ripple current is shown below.(Fig. 25).

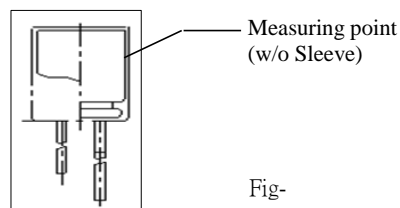

Fig-

Precautions in Using(Non-Solid Aluminum Electrolytic Capacitor)

I .Device circuits design considerations

1 .Confirm installation and operating requirements for capacitors, then use them within the performance limits prescribed in this catalog or product specifications.

2. Polarity

Aluminum electrolytic capacitors are polariz
Never apply a reverse voltage or AC voltage. Connecting with wrong polarity will short-circuit or damage the capacitor with the pressure relief vent opening early on. To identify the polarity of a capacitor, see the relevant diagram in the catalogs or product specifications, or the polarity marking on the body of the capacitor. Incidentally, the rubber end seal bungs of the radial lead type capacitors have a solder-flux gas escaping configuration, which is nothing to do with the polarity of the capacitors. For circuits where the polarity is occasionally reversed, use a bi-polar type of aluminum electrolytic capacitor. However, note that even bi-polar type capacitors must not be used for AC circuits.

3.Operating voltage

Do not apply an over-voltage that exceeds a rated voltage specified for the capacitors. The total peak value of the ripple voltage plus the DC voltage must not exceed the rated voltage of the capacitors. Although capacitors specify a surge voltage that exceeds the full rated voltage,it does not assure long-term use but limited use under specific conditions.

4. Ripple current

Do not apply an overcurrent that exceeds the rated ripple current specified for the capacitors. Excessive ripple current will increase heat production within the capacitors, causing the capacitors to be damaged as follows:

- Shorten lifetime
- Open pressure relief vent
- Short circuit

The rated ripple current is specified along with a specific ripple frequency. Where using the capacitors at any other ripple frequency other than specified frequency, calculate the allowable ripple current by multiplying the rated ripple current by a frequency compensation factor(Frequency Multiplier) specified for each product series.

5. Operating temperature (Category temperature)

Do not apply high temperatures that exceed the upper limit of the category temperature range specified for the capacitors. Using the capacitor at temperatures higher than the upper limit will considerably shorten the lifetime of the capacitor and make the pressure relief vent open.

In other words, lowering ambient temperatures will extend the expected lifetime of the capacitors.

6) Lifetime

Select the capacitors to meet the service life requirements of a device

7) Charging and discharging

Do not use capacitors in circuits intended for rapid charge and discharge cycle operations.

If capacitors are used in the circuits that repeat a charge and discharge with a large voltage drop or a rapid charge and discharge at a short interval cycle,capacitance will decrease and/or the capacitors will be damaged by internal heat generation.

Consult us for a heavy charge and discharge type of capacitor so that the capacitor will be designed in accordance with requirements of duty

cycle of charge and discharge, the number of cycles, discharging resistance and operating temperatures.

8. Failure mode of capacitors

Non-solid aluminum electrolytic capacitors have a limited lifetime which ends in an open circuit failure mode, in general. Depending on the product type and operating conditions, the failure mode may involve in opening of the pressure relief vent.

9.Capacitor insulation

Electrically isolate the following sections of a capacitor from the negative terminal, the positive terminal and the circuit patterns.

- The outer can case of a non-solid aluminum capacitor.
- The dummy terminal of a snap-in type non-solid aluminum capacitor, which is designed for mounting stability.

10. Outer sleeve

The outer sleeve of a capacitor does not assure electrical insulation (except for screw-terminal type capacitors). It should not be used where electrical insulation is required.

11. Operating conditions

Do not use/expose capacitors to the following conditions:

- ① Direct contact with water, salt water or oil, or high condensation environment.
- ② Direct sunlight.
- ③ Toxic gases such as hydrogen sulfide, sulfurous acid, nitrous acid, chlorine and its compounds, bromine and its compounds and ammonium.
- ④ Ozone, ultraviolet rays or radiation.
- ⑤ Extreme vibration or mechanical shock that exceeds limits in the catalogs or product specifications.

The standard vibration condition is applicable to JIS C 5101-4.

12. Mounting

① Non-solid aluminum electrolytic capacitors contain paper separators and electric-conductive electrolyte that contains organic solvent as main solvent material, both of which are flammable. If the electrolyte leaks onto a printed circuit board, it can erode the device circuit pattern, may short-circuit the copper traces, smoke and burn. Make sure of designing a PC board as follows:

- Provide the appropriate hole spacing on the PC board to match the terminal spacing of a capacitor.
- Provide the following adequate clearance space over the pressure relief vent of a capacitor to avoid blocking the correct opening of the pressure relief vent.

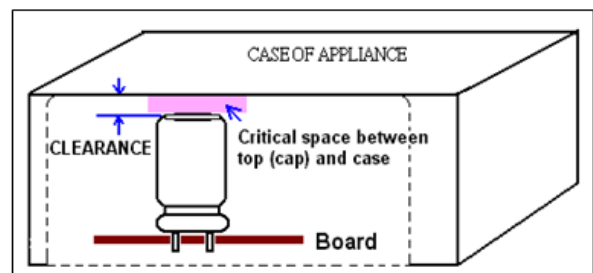

Case diameter	Clearance
Φ6.3 to Φ16 mm	≥ 2 mm
Φ18 to Φ 35 mm	≥ 3 mm
Φ40 mm & 以上	≥ 5 mm

- Do not locate any wire or circuit pattern over the pressure relief vent of a capacitor.
- If a capacitor is mounted with its pressure relief vent facing down on the PC board, provide a ventilation hole in the board beneath it to let gas escape when the vent opens.
- Do not print any copper trace under the seal (terminal) side of a capacitor. Copper traces should be 1 mm (preferably 2mm or more) spaced apart from the side of the capacitor body.
- Avoid locating any heat source components near capacitors or on the opposite side of the PC board under capacitors.
- In designing a double-sided PC board, do not locate any through-hole via or unnecessary hole underneath a capacitor.
- In designing a double-sided PC board, do not print any circuit pattern underneath a capacitor.

② For a screw terminal type capacitor, tightening the terminal screw and the mounting clamp should be within the maximum torque specified in the catalogs or product specifications. Do not mount a screw terminal type capacitor with the terminals facing downward.

Also, if the body of a capacitor is installed horizontally such as being laid on its side, do not position the pressure relief vent downward.

③ For a chip type capacitor, design the land patterns of the PC board accordance with the recommended footprint dimensions described in the catalogs or product specifications

13. Using capacitors for significantly safety-oriented applications

Consult us about capacitors for a device application affecting human safety (①Aviation and aerospace ②Nuclear ③Medical ④ or for any device whose failure will make an impact on society. Note that some products such as photoflash use capacitors which have been designed for specific applications cannot be used for any other application

14. Others

Design device circuits taking into consideration the following conditions

- ① Electrical characteristics of a capacitor depend on the temperature and frequency. In designing the device circuits, consider the change in the characteristics.
- ② If using more than one capacitor connected in parallel, design the device circuits to balance the current flow in individual capacitors.
- ③ If using more than one capacitor connected in series, connect shunting resistors in parallel with the individual capacitors to balance the voltage.

II. Installation

1. Assembling

- ① Do not try to reuse the capacitors once assembled and electrified, except only capacitors that are taken from a device for periodic inspection to measure their electrical characteristics.
- ② Capacitors may have been spontaneously recharged with time recovery phenomenon. In this case, through a resistor of approximately 1kΩ before use.
- ③ If non-solid aluminum electrolytic capacitors have been stored at any conditions more than 35°C and 75%RH for long storage periods. of time more limits specified in catalogs or product specifications, they may current. In this case, make pre-conditioning by applying the rated voltage through a resistor of approximately 1kΩ.
- ④ Confirm the rated capacitance and voltage of capacitors before installation.
- ⑤ Confirm the polarity of capacitors before installation.

⑥ Do not try to use the capacitors that were dropped to the floor and so forth.

⑦ Do not deform the can case of a capacitor.

⑧ Make sure that the terminal spacing of a capacitor equals the holes spacing on the PC board before installing the capacitor. For radial lead type capacitors, some standard pre-formed lead types are also available.

⑨ When installing a snap-in type capacitor on the PC board insert the terminals into the holes and press the capacitor down until the body is settled flush on the surface of the PC board (without the body standing off).

⑩ Do not apply excessive mechanical force to capacitors more than the limits prescribed in the catalogs or product specifications. Avoid excessive mechanical force while the capacitors are in the process of vacuum-picking, placing and positioning by automatic mounting machines or cutting the lead wires by automatic insertion machines.

2. Soldering and heat resistance

① For soldering using a soldering iron, consider the following conditions:

- Soldering conditions (temperature and time) should be within the limits prescribed in the catalogs or product specifications.

- If it is necessary to pre-form the terminal spacing of a capacitor to match the hole spacing on the PC board before assembly and soldering, do not make mechanical stress reach into the body of the capacitor but only the lead wires.

- Do not touch the body of a capacitor with the hot tip of the soldering iron.

② For flow soldering, consider the following conditions:

- Do not dip the body of a capacitor into a solder bath. Expose only the terminals to the melt solder with the PC board interposing between the solder and the body of the capacitor. Solder only the reverse side of the PC board where the body of the capacitor is not located.

- Soldering conditions should be within the limits prescribed in the catalogs or product specifications.

- Do not apply flux to any part of a capacitor other than the terminals.

- Do not let any other component lean against nor come into contact with the capacitor while soldering.

③ For reflow soldering, consider the following conditions:

- Soldering conditions (preheat, reflow temperature and time) should be within the limits prescribed in the catalogs or product specifications.

- When using the infrared heater and setting its temperatures, adjust the heating levels taking into consideration that the color and materials of a capacitor vary in their infrared absorbance.

- The allowable number of reflow passes is specified in the catalogs or product specifications.

- When mounting a capacitor on the double-sided PC board, do not place any wiring pattern underneath the capacitor.

- Please consult us about vapor phase soldering (VPS).

④ Do not try to reuse the capacitor that was removed from the PC board after soldering.

⑤ Only use chip type capacitors for reflow soldering. The other type capacitors are not designed for the reflow.

3. Lead free type reflow soldering condition (For Surface Mount Aluminium Electrolytic Capacitors)

- ① For reflow, use a thermal condition system such as infrared radiation or hot blast. Vapor heat transfer systems are not recommended.
- ② Observe proper soldering conditions (temperature, time, etc.) Do not exceed the specified limits.
- ③ Repeated reflowing :
 - Avoid reflowing twice if possible.
 - If repeated reflowing is unavoidable, contact us after measuring the first and the second reflow profiles and reflow interval at your side.
 - Do not attempt to reflow three times.

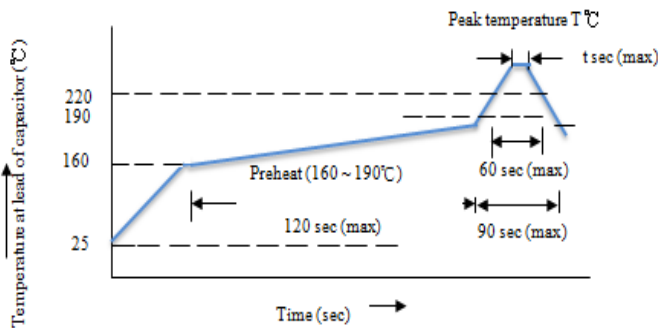

Size	T	t
φ4 ~ φ5 (4V ~ 50V)	250	10
	260	5
φ6.3 ~ φ10 (4V ~ 50V)	250	5
φ4 ~ φ10 63 ~ 100V	250	5

4. Handling after soldering

After soldering the PC board, do not apply the following mechanical stress to the capacitor:

- ① Do not tilt, push down or twist the body of the capacitor.
- ② Do not grab the body of the capacitor to carry the assembly
- ③ Do not hit anything against the capacitor. When stacking the assembled boards, do not put any of the PC boards or other components against the capacitor.
- ④ Do not drop the assembled board.

5. Cleaning assembly boards

- ① Do not clean capacitors with the following cleaning agents:
 - Halogenated solvents: cause capacitor failures due to corrosion.
 - Alkali system solvents: corrode (dissolve) the aluminum can case.
 - Terpene and petroleum system solvents: deteriorate the rubber seal materials.

• Xylene: deteriorates the rubber seal materials as well.
 • Acetone: erases the markings printed on a capacitor.
 Where cleaning is necessary, use only solvent resistant type that have been assured for the cleaning within the specific cleaning conditions prescriber in the catalogs or product specifications.

In particular, carefully set up the conditions for ultrasonic cleaning system.

- ② Where cleaning the solvent resistance type of aluminum electrolytic capacitors, confirm the following conditions:
 - Control the contamination (the conductivity, pH, specific gravity, water content, etc.) of the cleaning agents.
 - After the cleaning, do not leave the capacitors (assembly boards)

an environment of cleaning agent-rich or in a closed container. Sufficiently evaporate the residual cleaning agent from the boards and the capacitors by forced hot air at temperatures less than the upper limit of category temperature range for more than 10. In general, aluminum electrolytic capacitors are sensitive to contamination of halogen ions (particularly to chlorine on the properties of the electrolyte and rubber seal materials used in a capacitor, the halogen ions lead up to catastrophic failures on the capacitor. Where the inside of a capacitor has been contaminated with more than a certain amount of halogen ions and the capacitor is use, the corrosion reaction of aluminum occurs. The corrosion causes the capacitor to have a significant increase in leakage current with heat produced, open the pressure relief vent and become open circuit

Due to global environmental issues (greenhouse effects and other environmental destruction by depletion of the ozone layer), the conventional cleaning solvents of CFC113, Trichloroethylene and 1,1,1-trichloroethylene were replaced by substitutes.

The following are some substitute cleaning agents and allowable cleaning conditions:

- a) Fatty-alcohol cleaning agents
 - Pine Alpha ST-100S (Arakawa Chemical)
 - Clean Through 750H, 750K, 750L and 710M (Kao)
 - Technocare FRW-14, 15, 16 and 17 (Momentive Performance Materials)
- [Cleaning conditions]
- Either of immersion or ultrasonic cleaning, for a maximum of 10 and at a maximum liquid temperature of 60°C is acceptable. Make that the markings on the capacitor are not rubbed against any other component or the PC board during cleaning. Note that shower cleaning affects the markings on the capacitor.

- b) HCFC (Freon 225) as Alternative CFCs
 - AK225AES (Asahi Glass)
- [Cleaning conditions]

Solvent resistant type capacitors, which were originally developed to intend to resist Freon TE or Freon TES, are also capable of withstanding any one of immersion, ultrasonic or vapor cleaning, for a maximum of 5 minutes (or 2 minutes for KRE and KRE-BP series capacitors or 3 minutes for SRM series). However, this type of cleaning agent is not recommended to use, as the cleaning materials may be banned in near future in view of global environmental issues.

- c) IPA (Isopropyl Alcohol)
 - Immersion cleaning with a maximum flux concentration of 2 wt% is acceptable.

6. Adhesives and coating materials

- ① Do not use any adhesive or coating materials containing halogenated solvents.
- ② Make sure of the following conditions before applying adhesive or coating materials to a capacitor,
 - No flux residue nor stain is left between the rubber seal of a capacitor and PC board.
 - Dry the capacitor to remove residual cleaning agents before applying adhesive and coating materials. Do not cover up the entire surface of the rubber seal of the capacitor with adhesives or coating materials.
 - Heating and curing conditions for adhesives and coating materials should be followed as prescribed in the catalogs or product specifications.

- Covering up the entire surface of the rubber seal with resin mold materials will obstruct the normal diffusion of internal hydrogen gas from a capacitor and result in serious failures. Also, where the adhesive and coating materials contain a large amount of halogen ions, the halogen ions will contaminate the inside of the capacitor through the rubber seal materials, causing the capacitor to become a failure.
- Depending on solvent materials that the adhesive or coating materials contains, note that the outer sleeve of a capacitor may lose a gloss or whiten in appearance.

7. Fumigation

In exporting or importing electronic devices, they may be exposed to fumigation with halide such as methyl bromide. Where aluminum electrolytic capacitors are exposed to halide such as methyl bromide, the capacitors will be damaged with the corrosion reaction with halogen ions in the same way as cleaning agents. For the export and import, Nippon Chemi-Con considers using some packaging method and so forth so that fumigation is not required. For customers to export or import electronic devices, semi-assembly products or capacitor components, confirm if they will be exposed to fumigation and also consider final condition of packaging. (Note that either cardboard or vinyl package has a risk of fumigation gas penetration.)

III. Precautions during operation of devices

1. Never touch the terminals of a capacitor directly with bare hands.
2. Do not short-circuit between the capacitor terminals with anything conductive. Also, do not spill any conductive liquid such as acid or alkaline solution over a capacitor.
3. Confirm environmental conditions where the device will be placed. Do not use the device in the following environmental conditions:
 - ① Water or oil spatters, or high condensation environment
 - ② Direct sunlight.
 - ③ Ozone, ultraviolet rays or radiation.
 - ④ Toxic gases such as hydrogen sulfide, sulfuric acid, nitrous acid, chlorine and its compounds, bromine and its compounds and
 - ⑤ Severe vibration or mechanical shock conditions beyond the limits prescribed in the catalog or product specification.

The standard vibration condition is applicable to JIS C 5101-4.

IV. Maintenance inspections

1. For industrial use capacitors, make periodic inspections. Before the inspections, turn off the power supply of the device and discharge the electricity of the capacitors. When checking it by a ohm meter, confirm the polarity beforehand. Do not apply stress to the terminals of the capacitors during inspection.
2. Characteristics to be inspected
 - ① Significant damage in appearance: vent opening, electro-lyte etc.
 - ② Electrical characteristics: leakage current, capacitance, $\tan\delta$ and other characteristics prescribed in the catalogs or product specification.

If finding anything abnormal on the characteristics above, check the specifications of the capacitor and take appropriate actions such as replacement.

V. Capacitor venting

1. A capacitor with more than a certain case size has the pressure relief vent functioning to escape abnormal gas pressure increase.

If gas expels from a venting capacitor, disconnect the power supply of the device or unplug the power supply cord. If not disconnecting the power supply, the device circuit may be damaged due to the short circuit failure of the capacitor or short-circuited with the liquid that the gas was condensed to. It may cause secondary damages such as device burnout in the worst case scenario.

The gas that comes out of the open vent is vaporized electrolyte, not smoke.

2. The gas expelled from a venting capacitor is more than 100°C. Never expose your face to the capacitor. If your eyes are exposed to the gas or you inhale it, immediately flush your eyes and/or gargle with water. If the electrolyte comes in contact with the skin, wash with soap and water.

VI. Storage

1. Do not store capacitors at high temperature or high humidity. Store the capacitors indoors at temperatures of 5 to 35°C and humidities of less than 75%RH. In principle, aluminum electrolytic capacitors should be used within one year (Surface Mount is two years) after production.
2. Keep capacitors packed in the original packaging material wherever possible.
3. Avoid the following storage environmental conditions:
 - ① Water spattering, high temperatures, high humidity or condensation environment.
 - ② Oil spattering or oil mist filled.
 - ③ Salt water spattering or salt filled.
 - ④ Acidic toxic gases such as hydrogen sulfide, sulfuric acid, nitrous acid, chlorine, bromine and methyl bromide filled.
 - ⑤ Alkaline toxic gases such as ammonium filled.
 - ⑥ Acid or alkaline solutions spattering.
 - ⑦ Direct sunlight, ozone, ultraviolet rays or radiation.
 - ⑧ Extreme vibration or shock loading.

VII. Capacitor disposal

Please consult with a local organization for the proper disposal of industrial waste. For incinerating capacitors, apply a high-temperature incineration (over 800°C). Incinerating them at temperatures lower than that may produce toxic gases such as chlorine. To prevent capacitors from explosion, punch holes in or sufficiently crush the can cases of the capacitors, then incinerate.

Jamicon Series : VP

Teapo Series : VP Standard Series

■ Endurance:105°C,2000hrs

■ Recommended Applications: Standard SMD type product

■ Corresponding product to RoHS



Specifications

Item	Characteristics	
Category Temperature Range	-55 ~ +105°C	
Rated Voltage Range	2.5~25VDC	
Rated Capacitance Range	22~ 1500 μ F	
Capacitance Tolerance	$\pm 20\%$ (120Hz, 20°C)	
Surge Voltage	Rated voltage (V) x 1.15	
Leakage Current (20°C)	Less than or equal to the value of Table (After rated voltage applied for 2 minutes) I : Leakage Current (μ A) C : Capacitance(μ F) V : Rated Voltage Range(VDC)	
Dissipation Factor (MAX) ($\tan \delta$) (120Hz, 20°C)	WV	2.5~25
	$\tan \delta$	0.12
Temperature characteristic Impedance ratio (MAX)	Z(100KHz) / WV	2.5 ~ 25V
	Z-25°C / Z+20°C	≤ 1.15
	Z-55°C / Z+20°C	≤ 1.25
Endurance	After applying rated voltage for 2000 hours at 105°C, the capacitor shall meet the following requirement °	
	Appearance	No significant damage
	Capacitance Change	Within $\pm 20\%$ of the initial value
	Dissipation Factor	Not more than 150% of the initial specified value
	Equivalent Series Resistance	Not more than 150% of the initial specified value
Humidity Test	after subjecting 90 to 95% RH for 1000 hours at 60°C, the capacitors shall meet the requirement as Endurance °	
	Capacitance Change	Within $\pm 10\%$ of the initial value
	Dissipation Factor	Not more than 130% of the initial specified value
	Equivalent Series Resistance	Not more than 130% of the initial specified value
	Leakage Current	Not more than the initial specified value
Resistance to Soldering Heat *	Capacitance Change	Within $\pm 10\%$ of the initial value
	Dissipation Factor	Not more than 130% of the initial specified value
	Equivalent Series Resistance	Not more than 130% of the initial specified value
	Leakage Current	Not more than the initial specified value

*For any doubt about measured values, measure the leakage current again after the following voltage treatment °

Voltage treatment: Applying DC rated voltage to the capacitors for 2 hours at 105°C °

Diagram of Dimensions

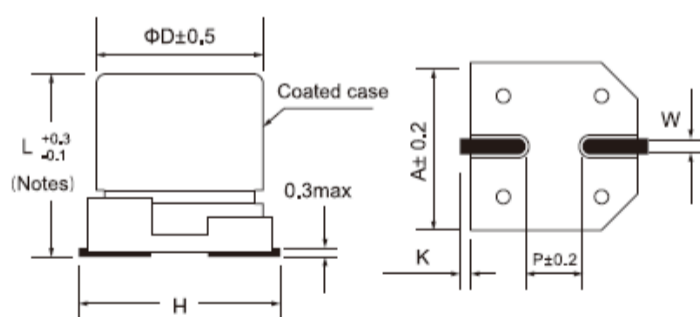
(Notes) $\Phi 8 \sim \Phi 10 \& 6.3 \times 7.7 = L \pm 0.3$

Marking : case with red printing

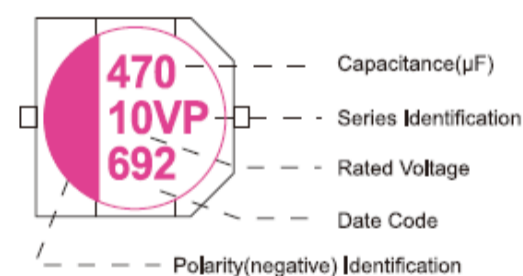

SIZE	$\Phi D \times L$	A	H(Max)	W	P	K
CA1	5x5.8	5.3	6.5	0.65 \pm 0.15	1.5 \pm 0.2	0.35+0.15/-0.2
EA1	6.3x5.8	6.6	7.8	0.65 \pm 0.15	1.8 \pm 0.2	0.35+0.15/-0.2
EA4	6.3x7.7	6.6	7.8	0.65 \pm 0.15	1.8 \pm 0.2	0.35+0.15/-0.2
GA6	8x10.4	8.3	10	0.9 \pm 0.2	3.1 \pm 0.2	0.7 \pm 0.2
HA5	10x10.2	10.3	12	0.9 \pm 0.2	4.6 \pm 0.2	0.7 \pm 0.2
HA8	10x12.2	10.3	12	0.9 \pm 0.2	4.6 \pm 0.2	0.7 \pm 0.2

Multiplier for Ripple Current

Frequency(HZ)	120 \leq F<1K	1K \leq F<10K	10K \leq F<100K	100K \leq F \leq 500K
Coefficient	0.05	0.30	0.70	1.00

Jamicon Series : VP

Teapo Series : VP

■Dimensions, Rated Ripple Current, Equivalent Series Resistance

Rated (Surge) Voltage(V)	Capacitance (μ F)	SIZE Φ DxL(mm)	RIPPLE (mA/rms,105 $^{\circ}$ C 100KHz)	ESR (m Ω ,20 $^{\circ}$ C 100KHz)	LC (μ A max/2min)	Rated (Surge) Voltage(V)	Capacitance (μ F)	SIZE Φ DxL(mm)	RIPPLE (mA/rms,105 $^{\circ}$ C 100KHz)	ESR (m Ω ,20 $^{\circ}$ C 100KHz)	LC (μ A max/2min)	
2.5 (2.88)	180	5x5.8	1970	30	300	10(11.5)	150	6.3x7.7	2560	27	300	
		6.3x5.8	2200	25	300		390	8x10.4	3020	22	780	
	220	6.3x5.8	2500	25	300		470	10x10.2	3500	14	940	
		6.3x7.7	2720	23	300			10x12.2	5300	12	940	
	470	6.3x7.7	2720	23	300		560	10x12.2	5300	12	1120	
	1000	8x10.4	3950	18	500		1000	10x12.2	5300	13	2000	
	1200	10x10.2	4000	12	600		16(18.4)	22	5x5.8	1210	90	300
	1500	10x10.2	4000	13	750			33	6.3x5.8	2050	37	300
10x12.2		5500	12	750	39	6.3x5.8		2050	37	300		
100		6.3x5.8	2450	26	300	47		6.3x5.8	1600	50	300	
4(4.6)	150	6.3x5.8	2450	26	300	82		6.3x7.7	2420	30	300	
	330	6.3x7.7	2650	25	300	100		6.3x7.7	2420	30	320	
	560	8x10.4	3950	18	448	120		6.3x7.7	2420	30	384	
	820	8x10.4	3950	18	656	150		8x10.4	3490	23	480	
		10x12.2	5500	10	656	180		8x10.4	3490	23	576	
	1200	10x10.2	4000	12	960	220		8x10.4	3490	23	704	
		10x12.2	5500	10	960	270	10x12.2	5050	14	704		
	6.3(7.25)	47	5x5.8	1380	35	300	330	10x10.2	3100	16	1056	
68		6.3x5.8	2400	27	300	330	10x12.2	5050	14	1056		
82		6.3x5.8	2400	27	300	390	8x10.4	3000	23	1248		
100		5x5.8	1380	35	300	470	10x10.2	3100	16	1504		
		6.3x5.8	2400	27	300		10x12.2	5050	14	1504		
120		6.3x5.8	2400	27	300	560	10x12.2	5050	14	1792		
220		6.3x5.8	2400	27	300	680	10x12.2	5050	14	2176		
		6.3x7.7	2650	25	300	820	10x12.2	5050	14	2624		
330		6.3x5.8	2400	27	415	20(23)	22	6.3x5.8	1650	50	300	
		6.3x7.7	2650	25	415		47	6.3x7.7	2000	45	300	
470		6.3x7.7	2650	25	592		100	8x10.4	3320	24	480	
680		8x10.4	3610	21	592	150	10x12.2	4220	21	600		
		8x10.4	3610	21	857	25(28.75)	22	6.3x5.8	900	65	300	
10x10.2		3650	12	857	27		6.3x7.7	1800	50	300		
		8x10.4	3610	21	1033		47	6.3x5.8	1300	65	300	
820		10x10.2	3650	12	1033		68	6.3x7.7	1800	45	340	
		10x12.2	5500	10	1033		100	8x10.4	3320	35	500	
1000		8x10.4	3610	21	1260		150	8x10.4	3320	35	750	
	10x12.2	5500	10	1260	180		10x10.2	3100	30	900		
10(11.5)	22	5x5.8	1270	40	300		220	8x10.4	3320	35	1100	
	33	5x5.8	1270	40	300		270	10x10.2	3320	30	1350	
	47	5x5.8	1270	40	300		330	10x12.2	3500	28	1650	
		6.3x5.8	2250	31	300							
	56	6.3x5.8	2250	31	300							
	100	6.3x5.8	2250	31	300							
		6.3x7.7	2560	27	300							

Jamicon Series : VC

Teapo Series : VC

Vehclar Special



- Endurance:105°C,2000hrs
- Recommended Applications: Vehclar Special
- Corresponding product to RoHS

Specifications

Item	Characteristics	
Category Temperature Range	-55 ~ +105°C	
Rated Voltage Range	2.5~25VDC	
Rated Capacitance Range	22~ 1500 μF	
Capacitance Tolerance	± 20 % (120Hz , 20°C)	
Surge Voltage	Rated voltage (V) x 1.15	
Leakage Current (20°C)	Less than or equal to the value of Table , (After rated voltage applied for 2 minutes) I : Leakage Current (μ A) C : Capacitance(μ F) V : Rated Voltage Range(VDC)	
Dissipation Factor (MAX) (tan δ) (120Hz ,20°C)	WV	2.5~25
	tan δ	0.12
Temperature characteristic Impedance ratio (MAX)	Z(100KHz) / WV	2.5 ~ 25V
	Z-25°C / Z+20°C	≤1.15
	Z-55°C / Z+20°C	≤1.25
Endurance	After applying rated voltage for 2000 hours at 105°C , the capacitor shall meet the following requirement °	
	Appearance	No significant damage
	Capacitance Change	Within ±20% of the initial value
	Dissipation Factor	Not more than 150% of the initial specified value
	Equivalent Series Resistance	Not more than 150% of the initial specified value
Humidity Test	after subjecting 90 to 95% RH for 1000 hours at 60°C , the capacitors shall meet the requirement as Endurance °	
	Capacitance Change	Within ±10% of the initial value
	Dissipation Factor	Not more than 130% of the initial specified value
	Equivalent Series Resistance	Not more than 130% of the initial specified value
	Leakage Current	Not more than the initial specified value
Resistance to Soldering Heat *	Capacitance Change	Within ±10% of the initial value
	Dissipation Factor	Not more than 130% of the initial specified value
	Equivalent Series Resistance	Not more than 130% of the initial specified value
	Leakage Current	Not more than the initial specified value

*For any doubt about measured values, measure the leakage current again after the following voltage treatment °
Voltage treatment: Applying DC rated voltage to the capacitors for 2 hours at 105°C °

Diagram of Dimensions

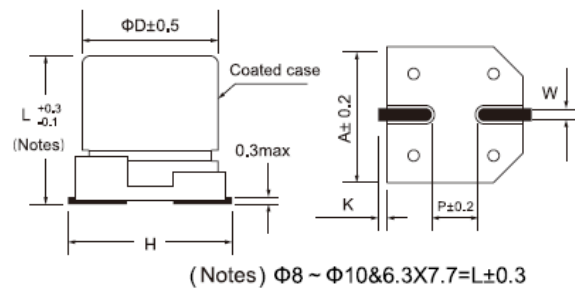

Marking : case with red printing

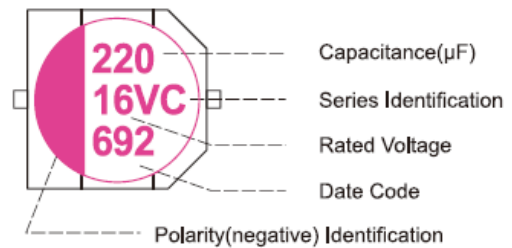

SIZE	Φ D x L	A	H(Max)	W	P	K
CA1	5x5.8	5.3	6.5	0.65±0.15	1.5±0.2	0.35+0.15/-0.2
EA1	6.3x5.8	6.6	7.8	0.65±0.15	1.8±0.2	0.35+0.15/-0.2
EA4	6.3x7.7	6.6	7.8	0.65±0.15	1.8±0.2	0.35+0.15/-0.2
GA6	8x10.4	8.3	10	0.9±0.2	3.1±0.2	0.7±0.2
HA5	10x10.2	10.3	12	0.9±0.2	4.6±0.2	0.7±0.2
HA8	10x12.2	10.3	12	0.9±0.2	4.6±0.2	0.7±0.2

Multiplier for Ripple Current

Frequency(HZ)	120 ≤ F < 1K	1K ≤ F < 10K	10K ≤ F < 100K	100K ≤ F ≤ 500K
Coefficient	0.05	0.30	0.70	1.00

Jamicon Series : VC

Teapo Series : VC

■Dimensions, Rated Ripple Current, Equivalent Series Resistance

Rated (Surge) Voltage(V)	Capacitance (μ F)	SIZE Φ DxL(mm)	RIPPLE (mA/rms, 105 °C 100KHz)	ESR (m Ω , 20°C 100KHz)	LC (μ A max/2min)
2.5 (2.88)	180	6.3x5.8	2200	25	300
	220	6.3x5.8	2500	25	300
	390	6.3x7.7	2720	23	300
	470	6.3x7.7	2720	23	300
4(4.6)	100	6.3x5.8	2450	26	300
	150	6.3x5.8	2450	26	300
	330	6.3x7.7	2650	25	300
	560	8x10.4	3950	18	448
	820	8x10.4	3950	18	656
	1200	10x10.2	4000	12	960
6.3(7.25)	100	5x5.8	1380	35	300
		6.3x5.8	2400	27	300
	120	6.3x5.8	2400	27	300
		6.3x5.8	2400	27	300
	330	6.3x5.8	2400	27	415
		6.3x7.7	2650	25	415
	470	6.3x7.7	2650	25	592
		8x10.4	3610	21	592
		8x10.4	3610	21	857
		10x10.2	3650	12	857
	820	10x10.2	3650	12	1033
		10x12.2	5500	10	1033
1000	8x10.4	3610	21	1260	
	10x12.2	5500	10	1260	
10(11.5)	22	5x5.8	1270	40	300
	33	5x5.8	1270	40	300
	47	5x5.8	1270	40	300
	56	6.3x5.8	2250	31	300
	100	6.3x5.8	2250	31	300
	150	6.3x7.7	2560	27	300
	390	8x10.4	3020	22	780
	470	10x10.2	3500	14	940
	560	10x12.2	5300	12	1120
	1000	10x12.2	5300	13	2000

Rated (Surge) Voltage(V)	Capacitance (μ F)	SIZE Φ DxL(mm)	RIPPLE (mA/rms, 105 °C 100KHz)	ESR (m Ω , 20°C 100KHz)	LC (μ A max/2min)
16(18.4)	22	5x5.8	1210	90	300
	47	6.3x5.8	1600	50	300
	82	6.3x7.7	2420	30	300
	100	6.3x7.7	2420	30	320
	120	6.3x7.7	2420	30	384
	150	8x10.4	3490	23	480
	180	8x10.4	3490	23	576
	220	8x10.4	3490	23	704
	270	8x10.4	3490	23	864
	330	10x10.2	3100	16	1056
	330	10x12.2	5050	14	1056
	470	10x12.2	5050	14	1504
	560	10x12.2	5050	14	1792
	680	10x12.2	5050	14	2176
	820	10x12.2	5050	14	2624
	20(23)	22	6.3x5.8	1650	50
47		6.3x7.7	2000	45	300
100		8x10.4	3320	24	480
150		10x12.2	4220	21	600
25(28.75)	22	6.3x5.8	900	65	300
		6.3x7.7	1800	50	300
	27	6.3x5.8	1270	60	300
	47	6.3x5.8	1300	65	300
		6.3x7.7	1800	45	300
	68	6.3x7.7	1800	45	340
	100	8x10.4	3320	35	500
	150	8x10.4	3320	35	750
	180	10x10.2	3100	30	900
	220	8x10.4	3320	35	1100
270	10x10.2	3320	30	1350	
330	10x12.2	3500	28	1650	

Jamicon Series : VB

Teapo Series : VB High capacitance & low ESR Series

- Endurance:105°C,2000hrs
- Recommended Applications: High capacitance & Ultra low ESR Series
- Corresponding product to RoHS

50V
LINE
UP



Specifications

Item	Characteristics	
Category Temperature Range	-55 ~ +105°C	
Rated Voltage Range	2.5~50VDC	
Rated Capacitance Range	33~ 1200 μF	
Capacitance Tolerance	± 20 % (120Hz , 20°C)	
Surge Voltage	Rated voltage (V) x 1.15	
Leakage Current (20°C)	Less than or equal to the value of Table , (After rated voltage applied for 2 minutes) I : Leakage Current (μ A) C : Capacitance(μ F) V : Rated Voltage Range(VDC)	
Dissipation Factor (MAX) (tan δ) (120Hz ,20°C)	WV	2.5~50
	tan δ	0.12
Temperature characteristic Impedance ratio (MAX)	WV	2.5 ~ 50V
	Z(100KHz) Z-25°C / Z+20°C	≤ 1.15
	Z-55°C / Z+20°C	≤ 1.25
Endurance	After applying rated voltage for 2000 hours at 105°C , the capacitor shall meet the following requirement °	
	Appearance	No significant damage
	Capacitance Change	Within ±20% of the initial value
	Dissipation Factor	Not more than 150% of the initial specified value
	Equivalent Series Resistance	Not more than 150% of the initial specified value
Humidity Test	after subjecting 90 to 95% RH for 1000 hours at 60°C , the capacitors shall meet the requirement as Endurance °	
	Capacitance Change	Within ±10% of the initial value
	Dissipation Factor	Not more than 130% of the initial specified value
	Equivalent Series Resistance	Not more than 130% of the initial specified value
	Leakage Current	Not more than the initial specified value
Resistance to Soldering Heat *	Capacitance Change	Within ±10% of the initial value
	Dissipation Factor	Not more than 130% of the initial specified value
	Equivalent Series Resistance	Not more than 130% of the initial specified value
	Leakage Current	Not more than the initial specified value

*For any doubt about measured values, measure the leakage current again after the following voltage treatment °
Voltage treatment: Applying DC rated voltage to the capacitors for 2 hours at 105°C °

Diagram of Dimensions

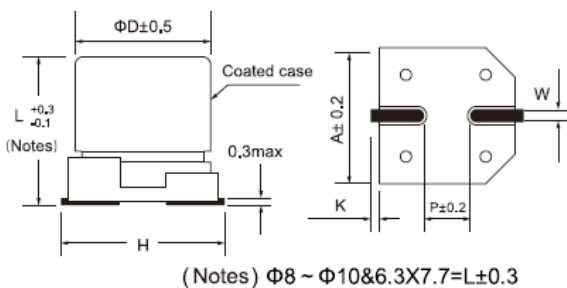

Marking : case with red printing

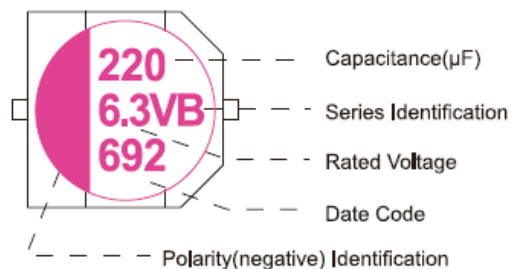

SIZE	Φ D x L	A	H(Max)	W	P	K
EA1	6.3x5.8	6.6	7.8	0.65±0.15	1.8±0.2	0.35+0.15/-0.2
EA4	6.3x7.7	6.6	7.8	0.65±0.15	1.8±0.2	0.35+0.15/-0.2
GA6	8x10.4	8.3	10	0.9±0.2	3.1±0.2	0.7±0.2
HA5	10x10.2	10.3	12	0.9±0.2	4.6±0.2	0.7±0.2
HA8	10x12.2	10.3	12	0.9±0.2	4.6±0.2	0.7±0.2

Multiplier for Ripple Current

Frequency(HZ)	120 ≤ F < 1K	1K ≤ F < 10K	10K ≤ F < 100K	100K ≤ F ≤ 500K
Coefficient	0.05	0.30	0.70	1.00

Jamicon Series : VB

Teapo Series : VB

■Dimensions, Rated Ripple Current, Equivalent Series Resistance

Rated (Surge) Voltage(V)	Capacitance (μ F)	SIZE Φ DxL(mm)	RIPPLE (mA/rms, 105 °C 100KHz)	ESR (mΩ, 20°C 100KHz)	LC (μ A max/2min)
2.5 (2.88)	330	6.3x5.8	3160	15	300
	390	6.3x5.8	3160	15	300
	470	6.3x5.8	3160	15	300
	560	6.3x5.8	3500	16	300
		6.3x7.7	3600	13	300
	820	8x10.4	4210	12	410
4(4.6)	270	6.3x5.8	3160	15	300
	330	6.3x5.8	3160	15	300
	470	8x10.4	4520	15	376
	560	8x10.4	4520	15	448
6.3(7.25)	100	6.3x5.8	2500	24	300
	120	6.3x5.8	2500	24	300
	150	6.3x5.8	3160	22	300
	220	6.3x5.8	3160	22	300
	330	6.3x5.8	3390	22	415
		6.3x7.7	3500	18	415
		8x10.4	4210	15	415
	470	6.3x7.7	3500	18	592
		8x10.4	4210	15	592
	560	8x10.4	4210	15	705
		10x10.2	5025	12	705
	820	8x10.4	4210	15	1033
		10x10.2	5025	12	1033
	1200	10x10.2	5025	12	1512

Rated (Surge) Voltage(V)	Capacitance (μ F)	SIZE Φ DxL(mm)	RIPPLE (mA/rms, 105 °C 100KHz)	ESR (mΩ, 20°C 100KHz)	LC (μ A max/2min)
10(11.5)	120	6.3x5.8	2600	22	300
	150	6.3x7.7	2880	21	300
	330	8x10.4	4000	17	660
	470	10x10.2	5025	12	940
		68	6.3x5.8	2440	25
16(18.4)	100	6.3x7.7	2700	24	300
		6.3x5.8	2440	25	320
	180	6.3x7.7	2700	24	320
		6.3x7.7	3320	22	576
	220	8x10.4	3890	18	576
		8x10.4	3890	18	704
		8x10.4	3890	18	864
		10x10.2	4350	16	1056
25(28.8)	470	10x12.2	6100	10	1504
	33	6.3x7.7	2500	45	300
35(40.25)	47	6.3x7.7	2500	45	300
		6.3x5.8	1800	55	300
	100	6.3x7.7	2200	50	329
		8x10.4	2600	35	700
50(57.50)	150	10x10.2	2800	35	1050
		10x12.2	2500	50	1000

Jamicon Series : VS

Teapo Series : VS Long Life & low ESR Series

- Endurance:105°C,5000hrs
- Recommended Applications: Long Life Series
- Corresponding product to RoHS



Specifications

Item	Characteristics	
Category Temperature Range	-55 ~ +105°C	
Rated Voltage Range	4~25VDC	
Rated Capacitance Range	27~ 470 μF	
Capacitance Tolerance	± 20 % (120Hz , 20°C)	
Surge Voltage	Rated voltage (V) x 1.15	
Leakage Current (20°C)	Less than or equal to the value of Table , (After rated voltage applied for 2 minutes) I : Leakage Current (μ A) C : Capacitance(μ F) V : Rated Voltage Range(VDC)	
Dissipation Factor (MAX) (tan δ) (120Hz ,20°C)	WV	4~25
	tan δ	0.12
Temperature characteristic Impedance ratio (MAX)	Z(100KHz) / WV	4 ~ 25V
	Z-25°C / Z+20°C	≤ 1.15
	Z-55°C / Z+20°C	≤ 1.25
Endurance	After applying rated voltage for 5000 hours at 105°C , the capacitor shall meet the following requirement °	
	Appearance	No significant damage
	Capacitance Change	Within ±20% of the initial value
	Dissipation Factor	Not more than 150% of the initial specified value
	Equivalent Series Resistance	Not more than 150% of the initial specified value
Humidity Test	after subjecting 90 to 95% RH for 1000 hours at 60°C , the capacitors shall meet the requirement as Endurance °	
	Capacitance Change	Within ±10% of the initial value
	Dissipation Factor	Not more than 130% of the initial specified value
	Equivalent Series Resistance	Not more than 130% of the initial specified value
	Leakage Current	Not more than the initial specified value
Resistance to Soldering Heat *	Capacitance Change	Within ±10% of the initial value
	Dissipation Factor	Not more than 130% of the initial specified value
	Equivalent Series Resistance	Not more than 130% of the initial specified value
	Leakage Current	Not more than the initial specified value

*For any doubt about measured values, measure the leakage current again after the following voltage treatment °
Voltage treatment: Applying DC rated voltage to the capacitors for 2 hours at 105°C °

Diagram of Dimensions

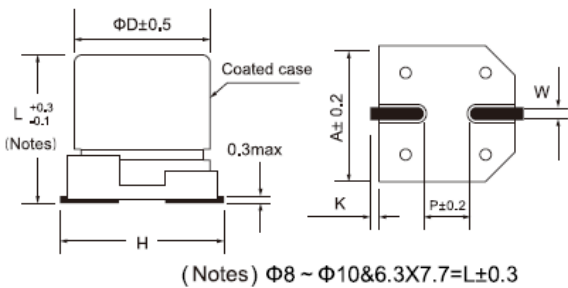

Marking : case with red printing

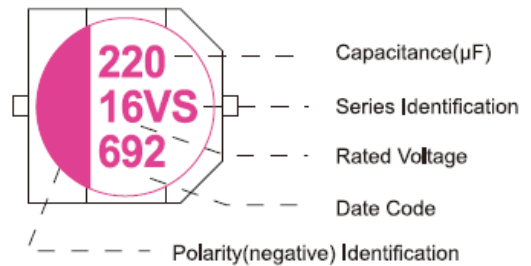

SIZE	Φ D x L	A	H(Max)	W	P	K
EA1	6.3x5.8	6.6	7.8	0.65±0.15	1.8±0.2	0.35+0.15/-0.2
EA4	6.3x7.7	6.6	7.8	0.65±0.15	1.8±0.2	0.35+0.15/-0.2
GA6	8x10.4	8.3	10	0.9±0.2	3.1±0.2	0.7±0.2
HA5	10x10.2	10.3	12	0.9±0.2	4.6±0.2	0.7±0.2
HA8	10x12.2	10.3	12	0.9±0.2	4.6±0.2	0.7±0.2

Multiplier for Ripple Current

Frequency(HZ)	120 ≤ F < 1K	1K ≤ F < 10K	10K ≤ F < 100K	100K ≤ F ≤ 500K
Coefficient	0.05	0.30	0.70	1.00

Jamicon Series : VS

Teapo Series : VS

■Dimensions, Rated Ripple Current, Equivalent Series Resistance

Rated (Surge) Voltage(V)	Capacitance (μ F)	SIZE Φ DxL(mm)	RIPPLE (mA/rms, 105 °C 100kHz)	ESR (m Ω , 20°C 100kHz)	LC (μ A max/2min)
4 (4.6)	150	6.3x5.8	2570	22	300
	330	6.3x5.8	2800	22	300
	470	6.3x7.7	2800	20	376
6.3(7.25)	100	6.3x5.8	2800	22	300
	120	6.3x5.8	2800	22	300
	220	6.3x5.8	2800	22	300
	470	10x10.2	4130	20	592
10(11.5)	47	6.3x5.8	2300	27	300
	56	6.3x5.8	2300	27	300
	68	6.3x5.8	2300	27	300

Rated (Surge) Voltage(V)	Capacitance (μ F)	SIZE Φ DxL(mm)	RIPPLE (mA/rms, 105 °C 100kHz)	ESR (m Ω , 20°C 100kHz)	LC (μ A max/2min)
10(11.5)	120	6.3x5.8	2300	27	300
	470	8x10.4	3000	22	940
16(18.4)	39	6.3x5.8	2200	30	300
	68	6.3x5.8	2200	30	300
	330	10x12.2	3800	14	1056
20(23)	27	6.3x5.8	2450	40	300
	180	10x10.2	3200	25	720
25(28.75)	150	8x10.4	1350	30	750
	220	10x10.2	1800	38	1100
	330	10x12.2	2800	30	1650

Jamicon Series : VA

Teapo Series : VA Long Life15000hrs Series



- Endurance:105°C,15000hrs
- Recommended Applications: Long Life15000hrs Series
- Corresponding product to RoHS

Specifications

Item	Characteristics	
Category Temperature Range	-55 ~ +105°C	
Rated Voltage Range	6.3~25VDC	
Rated Capacitance Range	22~ 1500 μF	
Capacitance Tolerance	± 20 % (120Hz , 20°C)	
Surge Voltage	Rated voltage (V) x 1.15	
Leakage Current (20°C)	Less than or equal to the value of Table , (After rated voltage applied for 2 minutes) I : Leakage Current (μ A) C : Capacitance(μ F) V : Rated Voltage Range(VDC)	
Dissipation Factor (MAX) (tan δ) (120Hz ,20°C)	WV	6.3~25
	tan δ	0.12
Temperature characteristic Impedance ratio (MAX)	Z(100KHz) \ WV	6.3 ~ 25V
	Z-25°C / Z+20°C	≤1.15
	Z-55°C / Z+20°C	≤1.25
Endurance	After applying rated voltage for 15000 hours at 105°C, the capacitor shall meet the following requirement °	
	Appearance	No significant damage
	Capacitance Change	Within ±20% of the initial value
	Dissipation Factor	Not more than 150% of the initial specified value
	Equivalent Series Resistance	Not more than 150% of the initial specified value
Humidity Test	after subjecting 90 to 95% RH for 1000 hours at 60°C , the capacitors shall meet the requirement as Endurance °	
	Capacitance Change	Within ±10% of the initial value
	Dissipation Factor	Not more than 130% of the initial specified value
	Equivalent Series Resistance	Not more than 130% of the initial specified value
	Leakage Current	Not more than the initial specified value
Resistance to Soldering Heat *	Capacitance Change	Within ±10% of the initial value
	Dissipation Factor	Not more than 130% of the initial specified value
	Equivalent Series Resistance	Not more than 130% of the initial specified value
	Leakage Current	Not more than the initial specified value

*For any doubt about measured values, measure the leakage current again after the following voltage treatment °
Voltage treatment: Applying DC rated voltage to the capacitors for 2 hours at 105°C °

Diagram of Dimensions

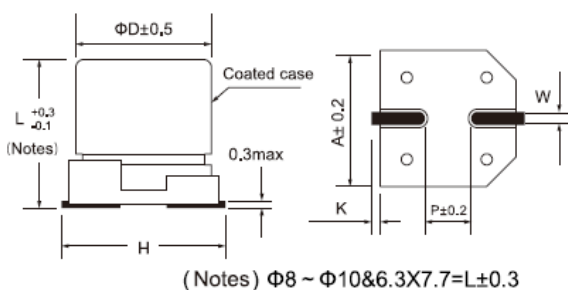

Marking : case with red printing

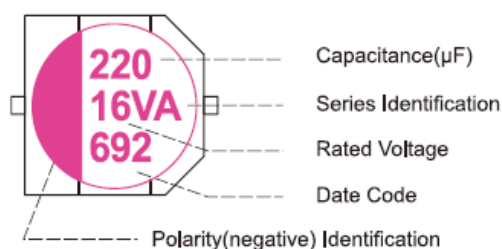

SIZE	Φ D x L	A	H(Max)	W	P	K
EA1	6.3x5.8	6.6	7.8	0.65±0.15	1.8±0.2	0.35+0.15/-0.2
EA4	6.3x7.7	6.6	7.8	0.65±0.15	1.8±0.2	0.35+0.15/-0.2
GA6	8x10.4	8.3	10	0.9±0.2	3.1±0.2	0.7±0.2
HA5	10x10.2	10.3	12	0.9±0.2	4.6±0.2	0.7±0.2
HA8	10x12.2	10.3	12	0.9±0.2	4.6±0.2	0.7±0.2

Multiplier for Ripple Current

Frequency(HZ)	120 ≤ F < 1K	1K ≤ F < 10K	10K ≤ F < 100K	100K ≤ F ≤ 500K
Coefficient	0.05	0.30	0.70	1.00

Jamicon Series : VA

Teapo Series : VA

■Dimensions,Rated Ripple Current,Equivalent Series Resistance

Rated (Surge) Voltage(V)	Capacitance (μ F)	SIZE Φ DxL(mm)	RIPPLE (mA/rms,105 °C 100KHz)	ESR (m Ω ,20°C 100KHz)	LC (μ A max/2min)
6.3(7.25)	220	6.3x5.8	2400	50	300
	470	6.3x7.7	2600	45	592
	820	8x10.4	3200	35	1033
	1500	10x10.2	4500	25	1890
10(11.5)	120	6.3x5.8	2000	45	300
	330	6.3x7.7	2400	40	660
	470	8x10.4	2800	35	940
	820	10x10.2	3500	35	1640
16(18.4)	100	6.3x5.8	2000	50	320
	180	6.3x7.7	2500	40	576
	330	8x10.4	3000	35	1056
	470	10x10.2	3200	30	1504
25(28.75)	47	6.3x5.8	1100	90	300
	100	6.3x7.7	1800	70	500
	220	8x10.4	2600	55	1100
	330	10x12.2	2800	50	1650

Jamicon Series : VD

Teapo Series : VD Long Life20000hrs Series



- Endurance:105°C,20000hrs
- Recommended Applications: Long Life20000hrs Series
- Corresponding product to RoHS

Specifications

Item	Characteristics	
Category Temperature Range	-55 ~ +105°C	
Rated Voltage Range	6.3~25VDC	
Rated Capacitance Range	22~ 1500 μF	
Capacitance Tolerance	± 20 % (120Hz , 20°C)	
Surge Voltage	Rated voltage (V) x 1.15	
Leakage Current (20°C)	Less than or equal to the value of Table , (After rated voltage applied for 2 minutes) I : Leakage Current (μ A) C : Capacitance(μ F) V : Rated Voltage Range(VDC)	
Dissipation Factor (MAX) (tan δ) (120Hz ,20°C)	WV	6.3~25
	tan δ	0.12
Temperature characteristic Impedance ratio (MAX)	Z(100KHz) / WV	6.3 ~ 25V
	Z-25°C / Z+20°C	≤1.15
	Z-55°C / Z+20°C	≤1.25
Endurance	After applying rated voltage for 20000 hours at 105°C , the capacitor shall meet the following requirement °	
	Appearance	No significant damage
	Capacitance Change	Within ±20% of the initial value
	Dissipation Factor	Not more than 150% of the initial specified value
	Equivalent Series Resistance	Not more than 150% of the initial specified value
Humidity Test	after subjecting 90 to 95% RH for 1000 hours at 60°C , the capacitors shall meet the requirement as Endurance °	
	Capacitance Change	Within ±10% of the initial value
	Dissipation Factor	Not more than 130% of the initial specified value
	Equivalent Series Resistance	Not more than 130% of the initial specified value
	Leakage Current	Not more than the initial specified value
Resistance to Soldering Heat *	Capacitance Change	Within ±10% of the initial value
	Dissipation Factor	Not more than 130% of the initial specified value
	Equivalent Series Resistance	Not more than 130% of the initial specified value
	Leakage Current	Not more than the initial specified value

*For any doubt about measured values, measure the leakage current again after the following voltage treatment °
Voltage treatment: Applying DC rated voltage to the capacitors for 2 hours at 105°C °

Diagram of Dimensions

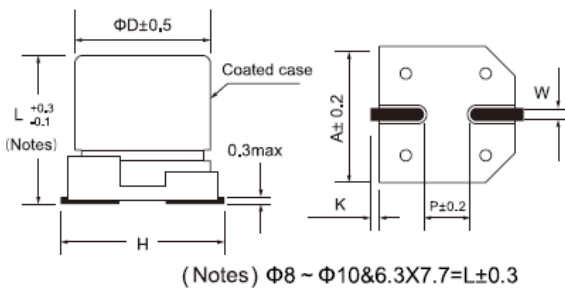

Marking : case with red printing

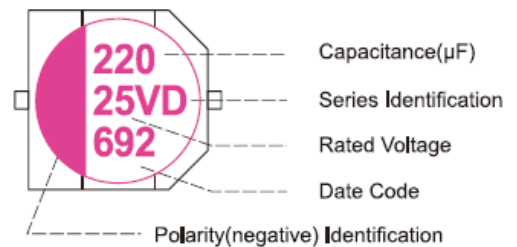

SIZE	Φ D x L	A	H(Max)	W	P	K
EA1	6.3x5.8	6.6	7.8	0.65±0.15	1.8±0.2	0.35+0.15/-0.2
EA4	6.3x7.7	6.6	7.8	0.65±0.15	1.8±0.2	0.35+0.15/-0.2
GA6	8x10.4	8.3	10	0.9±0.2	3.1±0.2	0.7±0.2
HA5	10x10.2	10.3	12	0.9±0.2	4.6±0.2	0.7±0.2
HA8	10x12.2	10.3	12	0.9±0.2	4.6±0.2	0.7±0.2

Multiplier for Ripple Current

Frequency(HZ)	120 ≤ F < 1K	1K ≤ F < 10K	10K ≤ F < 100K	100K ≤ F ≤ 500K
Coefficient	0.05	0.30	0.70	1.00

Jamicon Series : VD

Teapo Series : VD

■Dimensions, Rated Ripple Current, Equivalent Series Resistance

Rated (Surge) Voltage(V)	Capacitance (μ F)	SIZE Φ DxL(mm)	RIPPLE (mA/rms, 105 °C 100KHz)	ESR (m Ω , 20°C 100KHz)	LC (μ A max/2min)
6.3(7.25)	150	6.3x5.8	2000	55	300
	330	6.3x7.7	2400	50	415
	470	8x10.4	3000	40	592
	1000	10x10.2	4000	30	1260
10(11.5)	100	6.3x5.8	1800	55	300
	220	6.3x7.7	2200	45	440
	330	8x10.4	2500	40	660
	470	10x10.2	3200	40	940
16(18.4)	68	6.3x5.8	1800	70	300
	150	6.3x7.7	2000	50	480
	270	8x10.4	2800	40	864
	470	10x10.2	3000	35	1504
25(28.75)	22	6.3x5.8	800	95	300
	56	6.3x7.7	1100	75	300
	100	8x10.4	2500	60	500
	220	10x10.2	2800	55	1100
	330	10x12.2	3000	50	1650

Jamicon Series : VQ

Teapo Series : VQ 125°C/2000hrs&Low ESR



- Endurance:125°C,2000hrs
- Recommended Applications: High temperature resistant products
- Corresponding product to RoHS

Specifications

Item	Characteristics	
Category Temperature Range	-55 ~ +125°C	
Rated Voltage Range	2.5~25VDC	
Rated Capacitance Range	22~ 1500 μF	
Capacitance Tolerance	± 20 % (120Hz , 20°C)	
Surge Voltage	Rated voltage (V) x 1.15	
Leakage Current (20°C)	Less than or equal to the value of Table , (After rated voltage applied for 2 minutes) I : Leakage Current (μ A) C : Capacitance(μ F) V : Rated Voltage Range(VDC)	
Dissipation Factor (MAX) (tan δ) (120Hz ,20°C)	WV	2.5~25
	tan δ	0.12
Temperature characteristic Impedance ratio (MAX)	Z(100KHz) / WV	2.5 ~ 25V
	Z-25°C / Z+20°C	≤ 1.15
	Z-55°C / Z+20°C	≤ 1.25
Endurance	After applying rated voltage for 2000 hours at 125°C , the capacitor shall meet the following requirement °	
	Appearance	No significant damage
	Capacitance Change	Within ±20% of the initial value
	Dissipation Factor	Not more than 150% of the initial specified value
	Equivalent Series Resistance	Not more than 150% of the initial specified value
Humidity Test	after subjecting 90 to 95% RH for 1000 hours at 60°C , the capacitors shall meet the requirement as Endurance °	
	Capacitance Change	Within ±10% of the initial value
	Dissipation Factor	Not more than 130% of the initial specified value
	Equivalent Series Resistance	Not more than 130% of the initial specified value
	Leakage Current	Not more than the initial specified value
Resistance to Soldering Heat *	Capacitance Change	Within ±10% of the initial value
	Dissipation Factor	Not more than 130% of the initial specified value
	Equivalent Series Resistance	Not more than 130% of the initial specified value
	Leakage Current	Not more than the initial specified value

*For any doubt about measured values, measure the leakage current again after the following voltage treatment °
Voltage treatment: Applying DC rated voltage to the capacitors for 2 hours at 125°C °

Diagram of Dimensions

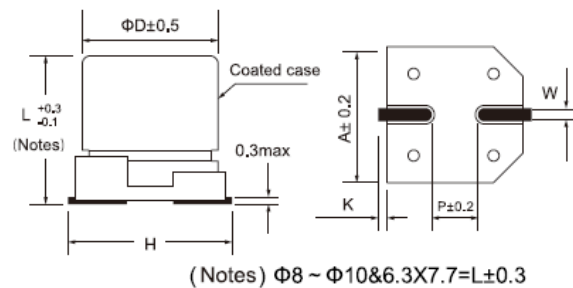

Marking : case with red printing

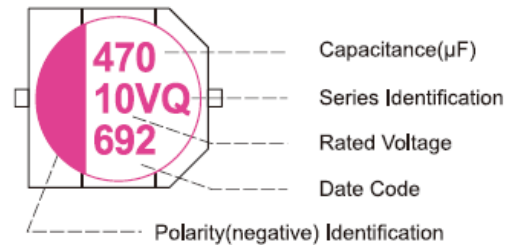

SIZE	Φ D x L	A	H(Max)	W	P	K
CA1	5x5.8	5.3	6.5	0.65±0.15	1.5±0.2	0.35+0.15/-0.2
EA1	6.3x5.8	6.6	7.8	0.65±0.15	1.8±0.2	0.35+0.15/-0.2
EA4	6.3x7.7	6.6	7.8	0.65±0.15	1.8±0.2	0.35+0.15/-0.2
GA6	8x10.4	8.3	10	0.9±0.2	3.1±0.2	0.7±0.2
HA5	10x10.2	10.3	12	0.9±0.2	4.6±0.2	0.7±0.2
HA8	10x12.2	10.3	12	0.9±0.2	4.6±0.2	0.7±0.2

Multiplier for Ripple Current

Frequency(HZ)	120 ≤ F < 1K	1K ≤ F < 10K	10K ≤ F < 100K	100K ≤ F ≤ 500K
Coefficient	0.05	0.30	0.70	1.00

Jamicon Series : VQ

Teapo Series : VQ

Dimensions, Rated Ripple Current, Equivalent Series Resistance

Rated (Surge) Voltage(V)	Capacitance (μ F)	SIZE Φ DxL(mm)	RIPPLE(mA/rms,100kHz)		ESR ($m\Omega$,20°C 100kHz)	LC (μ A max/2min)	Rated (Surge) Voltage(V)	Capacitance (μ F)	SIZE Φ DxL(mm)	RIPPLE(mA/rms,100kHz)		ESR ($m\Omega$,20°C 100kHz)	LC (μ A max/2min)	
			Tx : 125°C	Tx : 105°C						Tx : 125°C	Tx : 105°C			
2.5 (2.88)	220	6.3x5.8	790	2500	40	300	16(18.4)	47	6.3x5.8	500	1600	55	300	
	390	6.3x7.7	859	2720	30	300		82	6.3x7.7	764	2420	30	300	
	470	6.3x7.7	859	2720	30	300		100	6.3x7.7	764	2420	30	320	
	1000	8x10.4	1248	3950	25	500		150	8x10.4	1100	3490	25	480	
	1500	10x10.2	1264	4000	20	750		220	8x10.4	1100	3490	25	704	
10x12.2		1740	5500	20	750	270		8x10.4	1100	3490	25	864		
4(4.6)	100	6.3x5.8	445	2450	35	300		330	10x12.2	1560	5050	18	1056	
	330	6.3x7.7	837	2650	35	300		390	8x10.4	948	3000	25	1248	
	560	8x10.4	1250	3950	25	448		470	10x10.2	980	3100	20	1504	
	820	8x10.4	1250	3950	25	656			10x12.2	1600	5050	18	1504	
		10x12.2	1738	5500	20	656		560	10x12.2	1600	5050	18	1792	
	1200	10x10.2	1265	4000	20	960		680	10x12.2	1600	5050	18	2176	
		10x12.2	1738	5500	20	960		820	10x12.2	1600	5050	18	2624	
6.3(7.25)		47	5x5.8	436	1380	50		300	20(23)	22	6.3x5.8	520	1650	55
	68	6.3x5.8	758	2400	40	300		47		6.3x7.7	630	2000	50	300
	100	5x5.8	436	1380	50	300	100	8x10.4		1050	3320	30	480	
		6.3x5.8	758	2400	35	300	150	10x12.2		1333	4220	25	600	
	220	6.3x5.8	758	2400	35	300	25(28.75)	22	6.3x5.8	284	900	65	300	
		6.3x7.7	840	2650	30	300			6.3x7.7	568	1800	50	300	
	330	6.3x5.8	760	2400	35	415		47	6.3x5.8	410	1300	65	300	
		6.3x7.7	840	2650	35	415			6.3x7.7	568	1800	50	300	
	470	6.3x7.7	840	2650	30	592		68	6.3x7.7	568	1800	50	340	
		8x10.4	1140	3610	25	592		100	8x10.4	1050	3320	40	500	
	680	8x10.4	11740	3610	25	857		180	10x10.2	980	3100	35	900	
		10x10.2	1153	3650	20	857		220	8x10.4	1050	3320	40	1100	
	820	10x10.2	1153	3650	20	1033		270	10x10.2	1050	3320	35	1350	
		10x12.2	1740	5500	25	1033		330	10x12.2	1106	3500	33	1650	
	10(11.5)	22	5x5.8	400	1270	50	300	10(11.5)	22	5x5.8	400	1270	50	300
33		5x5.8	400	1270	50	300	47		5x5.8	400	1270	50	300	
47		5x5.8	400	1270	50	300	56		6.3x5.8	710	2250	40	300	
100		6.3x5.8	710	2250	40	300	100		6.3x5.8	710	2250	40	300	
		6.3x7.7	808	2560	33	300			6.3x7.7	808	2560	33	300	
150		6.3x7.7	808	2560	35	300	150		6.3x7.7	808	2560	35	300	
390		8x10.4	955	3020	28	780	390		8x10.4	955	3020	28	780	
470		10x10.2	1106	3500	20	940	470		10x10.2	1106	3500	20	940	
		10x12.2	1680	5300	20	940			10x12.2	1680	5300	20	940	
560		10x12.2	1680	5300	18	1120	560		10x12.2	1680	5300	18	1120	
1000		10x12.2	1680	5300	18	2000	1000		10x12.2	1680	5300	18	2000	

Jamicon Series : FG

Teapo Series : FG Standard Series

- Endurance:105°C,2000hrs
- Recommended Applications: standard
- Corresponding product to RoHS



Specifications

Item	Characteristics		
Category Temperature Range	-55 ~ +105°C		
Rated Voltage Range	2.5~25VDC		
Rated Capacitance Range	22~ 2200 μF		
Capacitance Tolerance	± 20 % (120Hz , 20°C)		
Surge Voltage	Rated voltage (V) x 1.15		
Leakage Current (20°C)	I ≤ 0.2CV or 300(μ A) whichever is greater (After rated voltage applied for 2 minutes) I : Leakage Current (μ A) C : Capacitance(μ F) V : Rated Voltage Range(VDC)		
Dissipation Factor (MAX) (tan δ) (120Hz ,20°C)	WV	2.5~10	12~25
	tan δ	0.08	0.12
Temperature characteristic Impedance ratio (MAX)	WV		2.5 ~ 25V
	Z(100KHz)	≤ 1.15	
	Z-25°C / Z+20°C	≤ 1.25	
Endurance	After applying rated voltage for 2000 hours at 105°C , the capacitor shall meet the following requirement °		
	Appearance	No significant damage	
	Capacitance Change	Within ±20% of the initial value	
	Dissipation Factor	Not more than 150% of the initial specified value	
	Equivalent Series Resistance	Not more than 150% of the initial specified value	
Humidity Test	after subjecting 90 to 95% RH for 1000 hours at 60°C , the capacitors shall meet the requirement as Endurance °		
	Surge voltage test After subjecting to 1000 cycles each consisting of charge with the surge voltage specified at normal temperature for 30 seconds through a protective resistor and discharge for 5 minutes 30 seconds,the capacitors shall meet the requirement as Endurance		
Failure rate(MAX)	1%per 1,000 hours(confidence level 60% at 105°C)		

Diagram of Dimensions

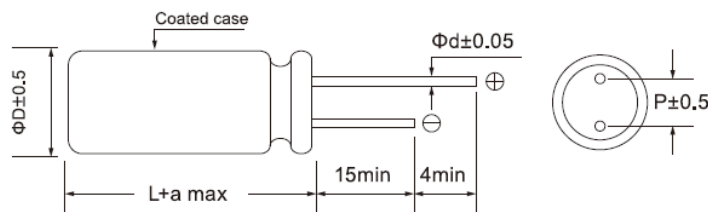

Marking : case with red printing

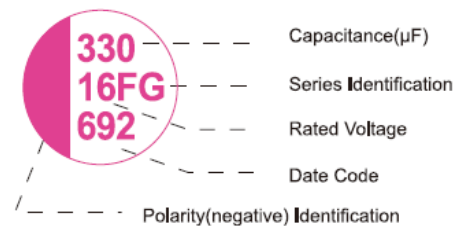

SIZE	Φ D x L	P	φ d	a
C07	5x7	2.0	0.5	1.5
C09	5x9	2.0	0.5	1.0
D07	5x7	2.5	0.5	1.0
D09	5x9	2.5	0.5	1.0
D11	5x11	2.5	0.5	1.0
E01	6.3x5.4	2.5	0.45	1.0
E06	6.3x6	2.5	0.5	1.5
E07	6.3x7	2.5	0.5	1.5
E08	6.3x8	2.5	0.5or0.6	1.0
E09	6.3x9	2.5	0.5	1.0

SIZE	Φ D x L	P	φ d	a
E11	6.3x11	2.5	0.5	1.0
G08	8x8	3.5	0.6	1.5
G09	8x9	3.5	0.6	1.5
G1B	8x11.5	3.5	0.6	1.0
G12	8x12	3.5	0.6	1.0
G15	8x15	3.5	0.6	1.5
H1A	10x10.5	5.0	0.6	1.0
H1C	10x12.5	5.0	0.6	1.0
H13	10x13	5.0	0.6	1.0
H16	10x16	5.0	0.6	1.0

Multiplier for Ripple Current

Frequency(HZ)	120 ≤ F < 1K	1K ≤ F < 10K	10K ≤ F < 100K	100K ≤ F ≤ 500K
Coefficient	0.05	0.30	0.70	1.00

Jamicon Series : FG

Teapo Series : FG

■Dimensions, Rated Ripple Current, Equivalent Series Resistance

Rated (Surge) Voltage(V)	Capacitance (μ F)	SIZE Φ DxL(mm)	RIPPLE (mA/rms,105°C 100KHz)	ESR (mΩ,20°C 100KHz)	Rated (Surge) Voltage(V)	Capacitance (μ F)	SIZE Φ DxL(mm)	RIPPLE (mA/rms,105°C 100KHz)	ESR (mΩ,20°C 100KHz)		
2.5 (2.88)	560	6.3x6	4000	10	7.5 (8.62)	390	5x9	3100	15		
		6.3x8	3160	20			5x9	3100	15		
	820	6.3x8	3160	20			500	5x9	3100	12	
		8x11.5	5600	7			680	6.3x9	3500	12	
	1500	10x12.5	5600	7		10 (11.5)	68	6.3x5.4	1810	30	
2200	10x12.5	5600	7	100	5x7			3500	11		
4 (4.6)	560	6.3x8	3160		20			6.3x5.4	2320	27	
		680	6.3x8	3160	20			150	6.3x5.4	2200	30
			8x11.5	5600	7			180	6.3x8	2820	25
	820	6.3x9	3160	20	220			6.3x8	2820	25	
		10x12.5	5600	7	270			6.3x8	2820	25	
	1000	8x11.5	5600	7	330			6.3x8	2820	25	
		10x12.5	5600	7				8x8	3500	11	
6.3 (7.25)	47	6.3x5.4	1810	30	470			6.3x9	2820	25	
		100	6.3x5.4	1810				40	8x11.5	5600	8
		180	6.3x5.4	1810	30			560	10x10.5	5050	8
	220	5x7	3500	11	8x11.5				5600	8	
		6.3x5.4	1810	30	680			10x12.5	6100	8	
	6.3x6	3160	15	8x11.5				5600	8		
	270	5x7	3500	11	820	10x12.5	6100	8			
		6.3x7	3500	11		1200	10x12.5	6100	8		
	6.8 (7.82)	330	5x7	3500	11	16(18.4)	22	5x7	2200	30	
			6.3x5.4	1810	30			6.3x5.4	2200	30	
			6.3x6	3390	22			33	6.3x5.4	2490	24
		390	5x9	3500	11		47		6.3x5.4	1650	35
			6.3x9	3500	11		68	6.3x6	2610	25	
		450	6.3x6	3390	22			6.3x5.4	1650	35	
			470	5x9	3190		28	100	6.3x5.4	2490	24
6.3x6		3390		22	6.3x8		2820		24		
6.3x8		3800		10	150		6.3x8	2820	25		
8x8		4200	8	8x8			3150	22			
560		6.3x8	4000	10	180		6.3x8	2820	25		
		8x8	4800	12			8x8	3500	16		
	680	6.3x9	3500	8	270		6.3x9	3100	20		
8x11.5		5600	7	8x8			3800	15			
820	6.3x9	3500	8	8x11.5			5000	11			
	8x11.5	5600	7	10x10.5	5050	14					
	10x10.5	5050	8	330	6.3x9	3100	20				
	10x12.5	5600	7		8x11.5	5000	11				
1000	8x8	4770	10	16 (18.4)	470	10x10.5	5050	14			
	8x11.5	5600	7			10x12.5	6100	10			
1200	8x11.5	5600	7			560	8x11.5	5000	11		
	10x10.5	5050	8				10x10.5	5050	11		
1500	8x11.5	5600	7	1000	10x12.5	6100	10				
	10x10.5	5050	8		10x12.5	5050	14				
	10x12.5	5600	7	16 (18.4)	680	8x11.5	5000	11			
2200	10x12.5	5600	7			10x12.5	6100	10			
7.5 (8.62)	270	5x7	2300			20	820	8x12	5000	10	
		5x7	2500			20		10x12.5	5000	10	
		5x7	2500	20	1000	8x15	5000	10			
		5x9	3100	15		10x12.5	5050	14			
		5x9	3100	15	25 (28.75)	33	6.3x8	1650	35		
		6.3x6	3100	15			47	6.3x10.5	1980	35	
		6.3x9	3500	11			68	8x8	2980	35	
		6.3x9	3500	11							
6.3x11	4200	10									
5x9	2690	15									

Jamicon Series : FR

Teapo Series : FR High Ripple & low ESR Series

- Endurance:105°C,2000hrs
- Recommended Applications: High ripple & low ESR Series
- Corresponding product to RoHS



Specifications

Item	Characteristics	
Category Temperature Range	-55 ~ +105°C	
Rated Voltage Range	2.5~6.3VDC	
Rated Capacitance Range	270~ 2700 μF	
Capacitance Tolerance	± 20 % (120Hz , 20°C)	
Surge Voltage	Rated voltage (V) x 1.15	
Leakage Current (20°C)	I ≤ 0.2CV or 300(μA) whichever is greater (After rated voltage applied for 2 minutes) I : Leakage Current (μ A) C : Capacitance(μ F) V : Rated Voltage Range(VDC)	
Dissipation Factor (MAX) (tan δ) (120Hz ,20°C)	WV	2.5~6.3
	tan δ	0.10
Temperature characteristic Impedance ratio (MAX)	Z(100KHz) / WV	2.5 ~ 6.3V
	Z-25°C / Z+20°C	≤ 1.15
	Z-55°C / Z+20°C	≤ 1.25
Endurance	After applying rated voltage for 2000 hours at 105°C , the capacitor shall meet the following requirement °	
	Appearance	No significant damage
	Capacitance Change	Within ±20% of the initial value
	Dissipation Factor	Not more than 150% of the initial specified value
	Equivalent Series Resistance	Not more than 150% of the initial specified value
Leakage Current	Not more than the initial specified value	
Humidity Test	after subjected 90 to 95% RH for 1000 hours at 60°C , the capacitors shall meet the requirement as Endurance °	
Surge voltage test	After subjected to 1000 cycles each consisting of charge with the surge voltage specified at normal temperature for 30 seconds through a protective resistor and discharge for 5 minutes 30 seconds,the capacitors shall meet the requirement as Endurance	
Failure rate(MAX)	1%per 1,000 hours(confidence level 60% at 105°C)	

Diagram of Dimensions

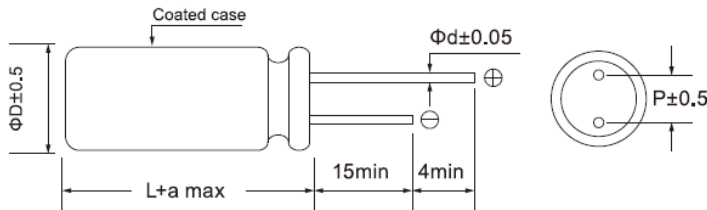

Marking : case with red printing

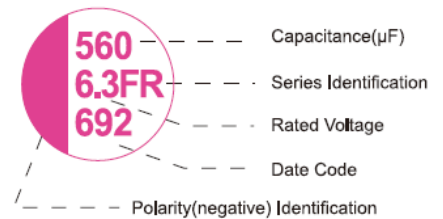

SIZE	ΦD X L	P	φ d	a
E08	6.3X8	2.5	0.5or0.6	1.0
E11	6.3x11	2.5	0.5	1.0
G08	8X8	3.5	0.6	1.5
G1B	8X11.5	3.5	0.6	1.0
H1C	10X12.5	5.0	0.6	1.0

Multiplier for Ripple Current

Frequency(HZ)	120 ≤ F < 1K	1K ≤ F < 10K	10K ≤ F < 100K	100K ≤ F ≤ 500K
Coefficient	0.05	0.30	0.70	1.00

Jamicon Series : FR

Teapo Series : FR

■Dimensions, Rated Ripple Current, Equivalent Series Resistance

Rated (Surge) Voltage(V)	Capacitance (μ F)	SIZE Φ D x L (mm)	RIPPLE (mA/rms, 105°C 100kHz)	ESR (m Ω , 20°C 100kHz)
2.5 (2.88)	560	6.3x8	5000	7
		8x8	6100	7
	680	8x8	6100	7
		8x11.5	6100	7
	820	6.3x8	5000	7
		8x8	6100	7
		8x11.5	6100	7
		1000	8x8	6100
		8x11.5	6100	7
		1500	8x11.5	6100
	2700	10x12.5	5600	8
4 (4.6)	560	6.3x8	5000	7
		8x8	6100	7
		8x11.5	6100	7
	680	8x8	6100	7
		8x11.5	6100	7
	1000	8x8	6100	7
		8x11.5	6100	7
		10x12.5	6100	7

Rated (Surge) Voltage(V)	Capacitance (μ F)	SIZE Φ D x L (mm)	RIPPLE (mA/rms, 105°C 100kHz)	ESR (m Ω , 20°C 100kHz)
4 (4.6)	1200	8x8	6100	7
	1500	8x11.5	6100	7
	1800	10x12.5	6500	9
6.3 (7.25)	270	6.3x8	4700	8
	330	6.3x8	4700	8
		6.3x8	4700	8
	470	8x8	5700	8
		6.3x8	4700	8
	560	6.3x8	4700	8
		8x8	5700	8
	680	8x8	5700	8
		8x11.5	5700	7
	820	8x8	5700	8
		8x11.5	5700	7
		8x8	5700	8
	1000	8x11.5	5700	7
		10x12.5	6100	7
		8x11.5	5700	7
1500	8x11.5	5700	7	
	10x12.5	6100	7	

Jamicon Series : FF

Teapo Series : FF Large capacitance Series

- Endurance:105°C,2000hrs
- Recommended Applications: Ultra low ESR & Large capacitance Series
- Corresponding product to RoHS

100
V
LINE
UP



Specifications

Item	Characteristics	
Category Temperature Range	-55 ~ +105°C	
Rated Voltage Range	6.3~100VDC	
Rated Capacitance Range	10~ 2200 μF	
Capacitance Tolerance	± 20 % (120Hz , 20°C)	
Surge Voltage	Rated voltage (V) x 1.15	
Leakage Current (20°C)	I ≤ 0.2CV or 300(μ A) whichever is greater (After rated voltage applied for 2 minutes) I : Leakage Current (μ A) C : Capacitance(μ F) V : Rated Voltage Range(VDC)	
Dissipation Factor (MAX) (tan δ) (120Hz ,20°C)	WV	6.3~100
	tan δ	0.12
Temperature characteristic Impedance ratio (MAX)	Z(100KHz) / WV	6.3 ~ 100V
	Z-25°C / Z+20°C	≤ 1.15
	Z-55°C / Z+20°C	≤ 1.25
Endurance	After applying rated voltage for 2000 hours at 105°C , the capacitor shall meet the following requirement °	
	Appearance	No significant damage
	Capacitance Change	Within ±20% of the initial value
	Dissipation Factor	Not more than 150% of the initial specified value
	Equivalent Series Resistance	Not more than 150% of the initial specified value
Humidity Test	after subjecting 90 to 95% RH for 1000 hours at 60°C , the capacitors shall meet the requirement as Endurance °	
	Surge voltage test After subjecting to 1000 cycles each consisting of charge with the surge voltage specified at normal temperature for 30 seconds through a protective resistor and discharge for 5 minutes 30 seconds,the capacitors shall meet the requirement as Endurance	
Failure rate(MAX)	1%per 1,000 hours(confidence level 60% at 105°C)	

Diagram of Dimensions

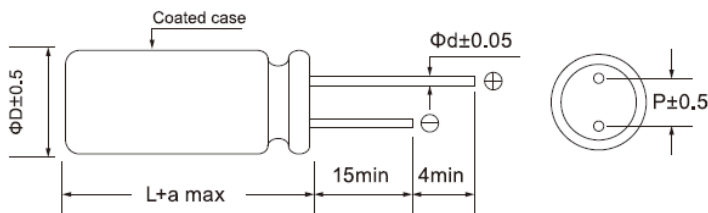

Marking : case with red printing

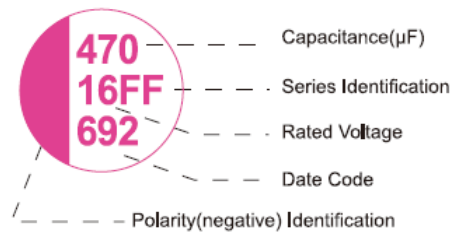

SIZE	Φ D x L	P	Φ d	a
E01	6.3x5.4	2.5	0.45	1.0
E06	6.3x6	2.5	0.5	1.5
E08	6.3x8	2.5	0.5or0.6	1.0
E11	6.3x11	2.5	0.5	1.0
G08	8x8	3.5	0.6	1.5
G1B	8x11.5	3.5	0.6	1.0
H1A	10x10.5	5.0	0.6	1.0
H1C	10x12.5	5.0	0.6	1.0
H13	10x13	5.0	0.6	1.0
H16	10x16	5.0	0.6	1.0

Multiplier for Ripple Current

Frequency(HZ)	120 ≤ F < 1K	1K ≤ F < 10K	10K ≤ F < 100K	100K ≤ F ≤ 500K
Coefficient	0.05	0.30	0.70	1.00

Jamicon Series : FF

Teapo Series : FF

■Dimensions, Rated Ripple Current, Equivalent Series Resistance

Rated (Surge) Voltage(V)	Capacitance (μ F)	SIZE Φ DxL(mm)	RIPPLE (mA/rms,105°C 100kHz)	ESR (mΩ,20°C 100kHz)	Rated (Surge) Voltage(V)	Capacitance (μ F)	SIZE Φ DxL(mm)	RIPPLE (mA/rms,105°C 100kHz)	ESR (mΩ,20°C 100kHz)	
6.3(7.25)	150	6.3x5.4	1810	30	25(28.75)	680	10x13	3500	20	
	680	6.3x8	4000	10		820	10x16	3500	20	
	1000	8x8	4200	10		1000	10x16	3500	20	
		8x11.5	4860	8	32(36.8)	22	6.3x8	990	60	
	1500	8x11.5	4860	8		47	6.3x8	990	60	
		10x10.5	5000	8		100	8x8	1200	50	
		10x12.5	5000	7		150	8x8	1500	50	
	10(11.5)	560	8x8	3000	12	35(40.25)	10	6.3x8	990	60
			8x8	3000	12		22	6.3x8	990	60
		680	8x11.5	4000	12		33	6.3x6	990	70
8x11.5			4000	12	47		6.3x8	990	60	
820		8x11.5	4000	12			68	6.3x8	990	60
	1000	10x12.5	4360	12	100		6.3x8	1200	40	
16(18.4)	470	8x11.5	4000	12			8x8	2000	50	
		8x11.5	4000	12	8x11.5		2300	35		
	560	8x11.5	4000	12	150		8x11.5	2300	35	
		820	10x12.5	4000	11		220	8x11.5	2400	35
25(28.75)	1000	10x12.5	4200	11	270	10x10.5		2400	35	
		10x12.5	4200	11	330	10x12.5	2500	25		
	22	6.3x5.4	1200	60	50(57.5)	33	8x8	1300	48	
		47	6.3x5.4	1200		60	47	8x8	1300	48
	68	6.3x8	1200	35		8x11.5		1500	45	
		6.3x6	1200	35		68	8x11.5	1500	45	
	100	8x8	1500	30			100	10x10.5	2200	40
		6.3x8	1500	35		10x12.5		2200	40	
	120	8x8	1500	30		120	10x12.5	2200	40	
		8x8	1500	30			63(72.45)	10	6.3x8	900
150	8x8	1600	28	33		8x8		1100	65	
	220	6.3x11	2000	20		47		8x8	1100	65
8x8		2280	28	56	10x12.5	1500		55		
270	8x11.5	2800	28	100	10x12.5	2000		50		
	330	8x11.5	2800	25	80(92.00)	10	6.3x8	900	90	
10x10.5		2800	25	47		10x12.5	1300	70		
470	10x12.5	3050	25	100(115.00)	22	10x12.5	1200	100		
	560	10x12.5	3050		25					

Jamicon Series : FL

Teapo Series : FL Special for Charger series

- Endurance:105°C,2000hrs
- Recommended Applications:Special charger series
- Corresponding product to RoHS



Specifications

Item	Characteristics		
Category Temperature Range	-55 ~ +105°C		
Rated Voltage Range	6.3~16VDC		
Rated Capacitance Range	22~ 2200 μF		
Capacitance Tolerance	± 20 % (120Hz , 20°C)		
Surge Voltage	Rated voltage (V) x 1.15		
Leakage Current (20°C)	I ≤ 0.2CV or 300(μ A) whichever is greater (After rated voltage applied for 2 minutes) I : Leakage Current (μ A) C : Capacitance(μ F) V : Rated Voltage Range(VDC)		
Dissipation Factor (MAX) (tan δ) (120Hz ,20°C)	WV	6.3~10	12~16
	tan δ	0.08	0.12
Temperature characteristic Impedance ratio (MAX)	WV		6.3 ~ 16V
	Z(100KHz)		
	Z-25°C / Z+20°C	≤ 1.15	
	Z-55°C / Z+20°C	≤ 1.25	
Endurance	After applying rated voltage for 2000 hours at 105°C , the capacitor shall meet the following requirement °		
	Appearance	No significant damage	
	Capacitance Change	Within ±20% of the initial value	
	Dissipation Factor	Not more than 150% of the initial specified value	
	Equivalent Series Resistance	Not more than 150% of the initial specified value	
	Leakage Current	Not more than the initial specified value	
Humidity Test	after subjecting 90 to 95% RH for 1000 hours at 60°C , the capacitors shall meet the requirement as Endurance °		
Surge voltage test	After subjecting to 1000 cycles each consisting of charge with the surge voltage specified at normal temperature for 30 seconds through a protective resistor and discharge for 5 minutes 30 seconds,the capacitors shall meet the requirement as Endurance		
Failure rate(MAX)	1%per 1,000 hours(confidence level 60% at 105°C)		

Diagram of Dimensions

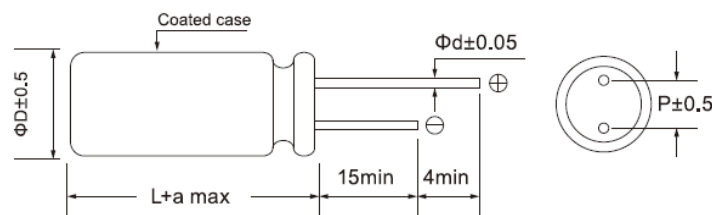

Marking : case with red printing

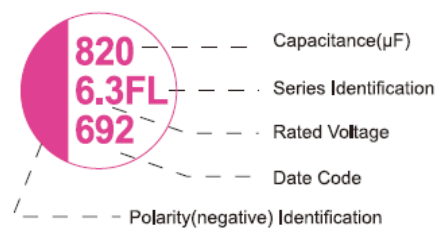

SIZE	Φ D x L	P	φ d	a
C07	5x7	2.0	0.5	1.5
C09	5x9	2.0	0.5	1.0
D07	5x7	2.5	0.5	1.0
D09	5x9	2.5	0.5	1.0
D11	5x11	2.5	0.5	1.0
E01	6.3x5.4	2.5	0.45	1.0
E06	6.3x6	2.5	0.5	1.5
E07	6.3x7	2.5	0.5	1.5

SIZE	Φ D x L	P	φ d	a
E08	6.3x8	2.5	0.5or0.6	1.0
E09	6.3x9	2.5	0.5	1.0
E11	6.3x11	2.5	0.5	1.0
G08	8x8	3.5	0.6	1.5
G09	8x9	3.5	0.6	1.5
G1B	8x11.5	3.5	0.6	1.0
H1A	10x10.5	5.0	0.6	1.0
H1C	10x12.5	5.0	0.6	1.0

Multiplier for Ripple Current

Frequency(HZ)	120 ≤ F < 1K	1K ≤ F < 10K	10K ≤ F < 100K	100K ≤ F ≤ 500K
Coefficient	0.05	0.30	0.70	1.00

Jamicon Series : FL

Teapo Series : FL

■Dimensions,Rated Ripple Current,Equivalent Series Resistance

Rated (Surge) Voltage(V)	Capacitance (μ F)	SIZE Φ DxL(mm)	RIPPLE (mA/rms,105°C 100kHz)	ESR (mΩ,20°C 100kHz)	Rated (Surge) Voltage(V)	Capacitance (μ F)	SIZE Φ DxL(mm)	RIPPLE (mA/rms,105°C 100kHz)	ESR (mΩ,20°C 100kHz)
6.3 (7.25)	47	6.3x5.4	1810	30	7.5 (8.62)	270	5x9	2690	15
	100	6.3x5.4	1810	40		390	5x9	3100	15
	180	6.3x5.4	1810	30		470	5x9	3100	15
	220	5x7	3500	11		500	5x9	3100	12
		6.3x5.4	1810	30		680	6.3x9	3500	12
	270	6.3x6	3160	15	10 (11.5)	68	6.3x5.4	1810	30
		5x7	3500	11		100	5x7	3500	11
	330	5x7	3500	11			6.3x5.4	2320	27
		6.3x5.4	1810	30		150	6.3x5.4	2200	30
	390	6.3x6	3390	22		180	6.3x8	2820	25
		5x9	3500	11		220	6.3x8	2820	25
	450	6.3x9	3500	8		270	6.3x8	2820	25
		5x9	3500	11		330	6.3x8	2820	25
	470	6.3x6	3390	22			8x8	3500	11
		6.3x8	3800	10		470	6.3x9	2820	25
	8x8	4200	8	8x11.5			5600	8	
	560	6.3x8	4000	10		560	8x11.5	5600	8
		8x8	4800	12			10x12.5	6100	8
	680	6.3x9	3500	8		680	8x11.5	5600	8
		8x11.5	5600	7			10x12.5	6100	8
	820	6.3x9	3500	8	820	8x11.5	5600	8	
		8x11.5	5600	7		10x12.5	6100	8	
		10x10.5	5050	8	1200	10x12.5	6100	8	
	1000	10x12.5	5600	7	16(18.4)	22	5x7	2200	30
8x8		4770	14	22		6.3x5.4	2200	30	
1200	8x11.5	5600	7			33	6.3x5.4	2490	24
	8x11.5	5600	7	47		6.3x5.4	1650	35	
10x10.5	5050	8	6.3x6			2610	25		
1500	8x11.5	5600	7	68		6.3x5.4	1650	35	
	10x10.5	5050	8	100		6.3x5.4	2490	24	
2200	10x12.5	5600	7			6.3x8	2820	24	
	10x12.5	5600	7	150		6.3x8	2820	25	
6.8 (7.82)	180	5x7	2300			20	180	8x8	3150
	220	5x7	2500	20		6.3x8		2820	25
	270	5x7	2500	20		270	8x8	3500	16
	330	5x9	3100	15			6.3x9	3100	20
	390	5x9	3100	15		8x8	3800	15	
	680	6.3x9	3500	11		8x11.5	5000	11	
	820	6.3x9	3500	11	10x10.5	5050	14		
1000	6.3x11	4200	10						

Jamicon Series : FS

Teapo Series : FS Large capacitance & Long Life & High Voltage Series

- Endurance: 105°C,5000hrs
- Recommended Applications:Large capacitance & Long Life & High Voltage Series
- Corresponding product to RoHS



■ Specifications

Item	Characteristics	
Category Temperature Range	-55 ~ +105°C	
Rated Voltage Range	20~50VDC	
Rated Capacitance Range	39~680 μF	
Capacitance Tolerance	± 20 % (120Hz , 20°C)	
Surge Voltage	Rated voltage (V) x 1.15	
Leakage Current (20°C)	I ≤ 0.2CV or 300(μ A)whichever is greater(After rated voltage applied for 2 minutes) I : Leakage Current (μ A) C : Capacitance(μ F) V : Rated Voltage Range(VDC)	
Dissipation Factor (MAX) (tan δ) (120Hz ,20°C)	WV	20~50
	tan δ	0.12
Temperature characteristic Impedance ratio (MAX)	Z(100KHz) / WV	20 ~ 50V
	Z-25°C / Z+20°C	≤ 1.15
	Z-55°C / Z+20°C	≤ 1.25
Endurance	After applying rated voltage for 5000 hours at 105°C , the capacitor shall meet the following requirement °	
	Appearance	No significant damage
	Capacitance Change	Within ±20% of the initial value
	Dissipation Factor	Not more than 150% of the initial specified value
	Equivalent Series Resistance	Not more than 150% of the initial specified value
Humidity Test	after subjecting 90 to 95% RH for 1000 hours at 60°C , the capacitors shall meet the requirement as Endurance °	
	Surge voltage test After subjecting to 1000 cycles each consisting of charge with the surge voltage specified at normal temperature for 30 seconds through a protective resistor and discharge for 5 minutes 30 seconds,the capacitors shall meet the requirement as Endurance	
Failure rate(MAX)	0.5%per 1,000 hours(confidence level 60% at 105°C)	

■ Diagram of Dimensions

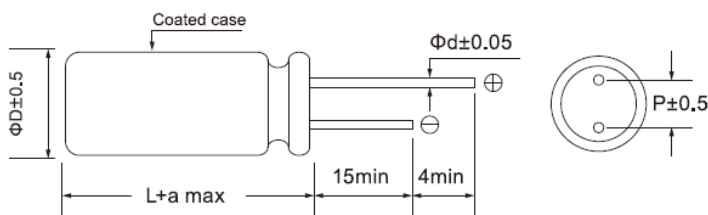

■ Marking : case with red printing

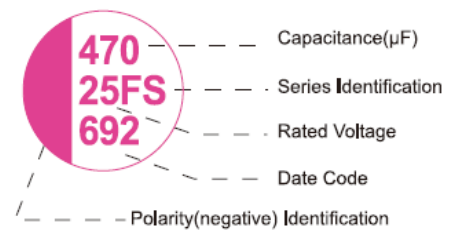

尺寸代码	ΦD x L	P	Φd	a
G08	8x8	3.5	0.6	1.5
G1B	8x11.5	3.5	0.6	1.0
H1B	10x11.5	5.0	0.6	1.0
H1C	10x12.5	5.0	0.6	1.0

■ Multiplier for Ripple Current

Frequency(HZ)	120 ≤ F < 1K	1K ≤ F < 10K	10K ≤ F < 100K	100K ≤ F ≤ 500K
Coefficient	0.05	0.30	0.70	1.00

Jamicon Series : FS

Teapo Series : FS

■Dimensions,Rated Ripple Current,Equivalent Series Resistance

Rated (Surge) Voltage(V)	Capacitance (μ F)	SIZE Φ DxL(mm)	RIPPLE (mA/rms,105°C 100KHz)	ESR (m Ω ,20°C 100KHz)
20(23)	390	8x11.5	1760	25
	680	10x11.5	2800	25
25(28.75)	150	8x11.5	1760	25
	220	8x11.5	1760	25
	270	8x11.5	1760	25
	330	10x12.5	2050	25
	470	10x12.5	2050	25
35(40.25)	39	8x8	1500	50
	56	8x8	1500	50

Rated (Surge) Voltage(V)	Capacitance (μ F)	SIZE Φ DxL(mm)	RIPPLE (mA/rms,105°C 100KHz)	ESR (m Ω ,20°C 100KHz)	
35(40.25)	100	8x8	1500	50	
		8x11.5	1760	35	
	150	8x11.5	1760	35	
		220	8x11.5	1760	35
50(57.5)	270	10x12.5	2050	25	
		47	8x11.5	1760	38
	100	56	8x11.5	1760	38
		82	10x12.5	2050	35
		100	10x12.5	2050	35

Jamicon Series : FP

Teapo Series : FP 8mm height & Low ESR Series

- Endurance:105°C,3000hrs
- Recommended Applications:8mm height & Ultra low ESR Series
- Corresponding product to RoHS



Dimensions, Rated Ripple Current, Equivalent Series Resistance

Item	Characteristics		
Category Temperature Range	-55 ~ +105°C		
Rated Voltage Range	2.5~25VDC		
Rated Capacitance Range	10~ 1200 μF		
Capacitance Tolerance	± 20 % (120Hz , 20°C)		
Surge Voltage	Rated voltage (V) x 1.15		
Leakage Current (20°C)	I ≤ 0.2CV or 300(μ A) whichever is greater (After rated voltage applied for 2 minutes) I : Leakage Current (μ A) C : Capacitance(μ F) V : Rated Voltage Range(VDC)		
Dissipation Factor (MAX) (tan δ) (120Hz ,20°C)	WV	2.5~10	16~25
	tan δ	0.08	0.12
Temperature characteristic Impedance ratio (MAX)	Z(100KHz) \ WV	2.5 ~ 25V	
	Z-25°C / Z+20°C	≤ 1.15	
	Z-55°C / Z+20°C	≤ 1.25	
Endurance	After applying rated voltage for 3000 hours at 105°C , the capacitor shall meet the following requirement °		
	Appearance	No significant damage	
	Capacitance Change	Within ±20% of the initial value	
	Dissipation Factor	Not more than 150% of the initial specified value	
	Equivalent Series Resistance	Not more than 150% of the initial specified value	
Leakage Current	Not more than the initial specified value		
Humidity Test	after subjecting 90 to 95% RH for 1000 hours at 60°C , the capacitors shall meet the requirement as Endurance °		
Surge voltage test	After subjecting to 1000 cycles each consisting of charge with the surge voltage specified at normal temperature for 30 seconds through a protective resistor and discharge for 5 minutes 30 seconds,the capacitors shall meet the requirement as Endurance		
Failure rate(MAX)	1%per 1,000 hours(confidence level 60% at 105°C)		

Diagram of Dimensions

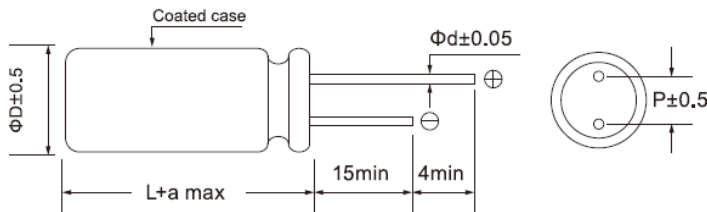

Marking : case with red printing

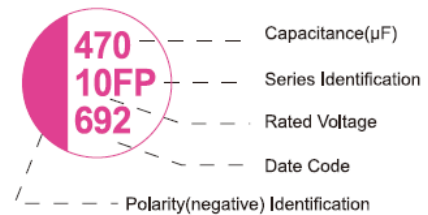

SIZE	Φ D x L	P	φ d	a
E08	6.3x8	2.5	0.6	1.0
G08	8x8	3.5	0.6	1.5

Multiplier for Ripple Current

Frequency(HZ)	120 ≤ F < 1K	1K ≤ F < 10K	10K ≤ F < 100K	100K ≤ F ≤ 500K
Coefficient	0.05	0.30	0.70	1.00

Jamicon Series : FP

Teapo Series : FP

■Dimensions,Rated Ripple Current,Equivalent Series Resistance

Rated (Surge) Voltage(V)	Capacitance (μ F)	SIZE Φ DxL(mm)	RIPPLE (mA/rms,105°C 100kHz)	ESR (m Ω ,20°C 100kHz)	Rated (Surge) Voltage(V)	Capacitance (μ F)	SIZE Φ DxL(mm)	RIPPLE (mA/rms,105°C 100kHz)	ESR (m Ω ,20°C 100kHz)
2.5 (2.88)	560	6.3x8	4200	8	10 (11.5)	470	8x8	3500	11
		8x8	5600	8		560	8x8	5000	10
	820	6.3x8	4200	8	16(18.4)	100	6.3x8	2820	25
		8x8	5600	8		150	6.3x8	2820	25
		1200	8x8	5600		8	220	6.3x8	2820
	6.3x8		4200	8		270	8x8	3500	11
6.3 (7.25)	470	6.3x8	4200	8		330	8x8	3500	11
		8x8	5600	8		470	8x8	4200	11
	560	6.3x8	4200	8		560	8x8	4200	11
		8x8	5600	8	25 (28.75)	10	6.3x8	1200	80
		820	8x8	5600		8	22	6.3x8	1650
6.3x8	2820		25	33		6.3x8	1650	35	
10 (11.5)	220	6.3x8	2820	25		56	8x8	1980	35
		8x8	3500	11		68	8x8	1980	35
	270	6.3x8	2820	25					
		6.3x8	2820	25					
330	6.3x8	2820	25						
	8x8	3500	11						

Jamicon Series : FH

Teapo Series : FH Long life & low ESR Series

- Endurance:105°C,5000hrs
- Recommended Applications: Long life & Ultra low ESR Series
- Corresponding product to RoHS



Specifications

Item	Characteristics	
Category Temperature Range	-55 ~ +105°C	
Rated Voltage Range	2.5~16VDC	
Rated Capacitance Range	100~ 1800 μF	
Capacitance Tolerance	± 20 % (120Hz , 20°C)	
Surge Voltage	Rated voltage (V) x 1.15	
Leakage Current (20°C)	I ≤ 0.2CV or 300(μ A) whichever is greater (After rated voltage applied for 2 minutes) I : Leakage Current (μ A) C : Capacitance(μ F) V : Rated Voltage Range(VDC)	
Dissipation Factor (MAX) (tan δ) (120Hz ,20°C)	WV	2.5~16
	tan δ	0.12
Temperature characteristic Impedance ratio (MAX)	Z(100KHz) \ WV	2.5 ~ 16V
	Z-25°C / Z+20°C	≤ 1.15
	Z-55°C / Z+20°C	≤ 1.25
Endurance	After applying rated voltage for 5000 hours at 105°C , the capacitor shall meet the following requirement °	
	Appearance	No significant damage
	Capacitance Change	Within ±20% of the initial value
	Dissipation Factor	Not more than 150% of the initial specified value
	Equivalent Series Resistance	Not more than 150% of the initial specified value
Humidity Test	after subjecting 90 to 95% RH for 1000 hours at 60°C , the capacitors shall meet the requirement as Endurance °	
	Surge voltage test After subjecting to 1000 cycles each consisting of charge with the surge voltage specified at normal temperature for 30 seconds through a protective resistor and discharge for 5 minutes 30 seconds,the capacitors shall meet the requirement as Endurance	
Failure rate(MAX)	1%per 1,000 hours(confidence level 60% at 105°C)	

Diagram of Dimensions

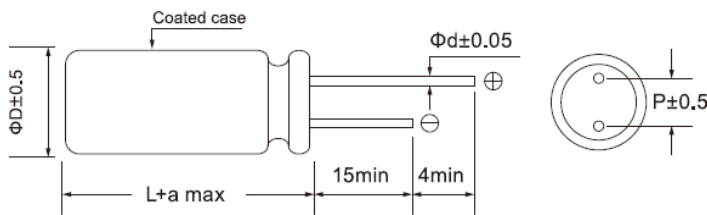

Marking : case with red printing

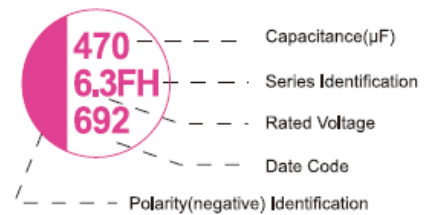

SIZE	Φ D x L	P	Φ d	a
E01	6.3x5.4	2.5	0.45	1.0
E08	6.3x8	2.5	0.5or0.6	1.0
G08	8x8	3.5	0.6	1.5
G1B	8x11.5	3.5	0.6	1.0
H1C	10x12.5	5.0	0.6	1.0
G15	8x15	3.5	0.6	1.5

Multiplier for Ripple Current

Frequency(HZ)	120 ≤ F < 1K	1K ≤ F < 10K	10K ≤ F < 100K	100K ≤ F ≤ 500K
Coefficient	0.05	0.30	0.70	1.00

Jamicon Series : FH

Teapo Series : FH Long life & low ESR Series

■Dimensions, Rated Ripple Current, Equivalent Series Resistance

Rated (Surge) Voltage(V)	Capacitance (μ F)	SIZE Φ DxL(mm)	RIPPLE (mA/rms, 105°C 100kHz)	ESR (m Ω , 20°C 100kHz)
2.5(2.87)	330	6.3x8	3500	8
	560	6.3x5.4	3000	16
		6.3x8	3500	7
	820	6.3x8	3500	7
		8x8	5000	7
4(4.6)	560	6.3x8	3500	8
		8x8	6100	8
	680	8x11.5	6100	7
	1500	10x12.5	6100	7
6.3(7.25)	220	6.3x5.4	1700	45
	330	6.3x8	3500	10
	470	6.3x8	3500	10
		8x8	3500	10
	560	6.3x8	3500	10
	820	8x11.5	3500	8
	1200	8x11.5	3500	8
	1500	10x12.5	4500	8
1800	10x12.5	5000	8	
10(11.5)	220	6.3x8	2500	15
	270	6.3x8	2800	15

Rated (Surge) Voltage(V)	Capacitance (μ F)	SIZE Φ DxL(mm)	RIPPLE (mA/rms, 105°C 100kHz)	ESR (m Ω , 20°C 100kHz)	
10(11.5)	330	8x11.5	3500	10	
	560	8x11.5	5000	10	
	680	8x11.5	5000	10	
16(18.4)	100	6.3x5.4	2490	24	
		6.3x8	2490	30	
	180	6.3x8	2490	25	
	220	8x11.5	3000	15	
		270	6.3x8	2500	24
			6.3x8	3500	15
	270	8x8	3500	15	
		8x11.5	3500	15	
	330	8x8	3500	15	
		8x11.5	3500	15	
	470	10x12.5	4200	15	
		560	8x11.5	3500	12
	560	10x12.5	6100	10	
		680	8x15	3500	11
	820	10x12.5	4000	11	
1000		10x12.5	4000	11	

Jamicon Series : FC

Teapo Series : FC Long Life 15000hrs Series

- Endurance: 105°C,15000hrs
- Recommended Applications:Long Life 15000hrs Series
- Corresponding product to RoHS



Specifications

Item	Characteristics	
Category Temperature Range	-55 ~ +105°C	
Rated Voltage Range	6.3~80VDC	
Rated Capacitance Range	10~2200 μF	
Capacitance Tolerance	± 20 % (120Hz , 20°C)	
Surge Voltage	Rated voltage (V) x 1.15	
Leakage Current (20°C)	I ≤ 0.2CV or 300(μ A)whichever is greater(After rated voltage applied for 2 minutes) I : Leakage Current (μ A) C : Capacitance(μ F) V : Rated Voltage Range(VDC)	
Dissipation Factor (MAX) (tan δ) (120Hz ,20°C)	WV	6.3~80
	tan δ	0.12
Temperature characteristic Impedance ratio (MAX)	Z(100KHz) / WV	6.3 ~ 80V
	Z-25°C / Z+20°C	≤ 1.15
	Z-55°C / Z+20°C	≤ 1.25
Endurance	After applying rated voltage for 15000 hours at 105°C , the capacitor shall meet the following requirement °	
	Appearance	No significant damage
	Capacitance Change	Within ±20% of the initial value
	Dissipation Factor	Not more than 150% of the initial specified value
	Equivalent Series Resistance	Not more than 150% of the initial specified value
Humidity Test	after subjecting 90 to 95% RH for 1000 hours at 60°C , the capacitors shall meet the requirement as Endurance °	
	Surge voltage test After subjecting to 1000 cycles each consisting of charge with the surge voltage specified at normal temperature for 30 seconds through a protective resistor and discharge for 5 minutes 30 seconds,the capacitors shall meet the requirement as Endurance	
Failure rate(MAX)	0.5%per 1,000 hours(confidence level 60% at 105°C)	

Diagram of Dimensions

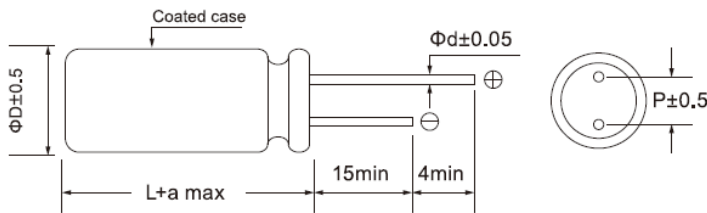

Marking : case with red printing

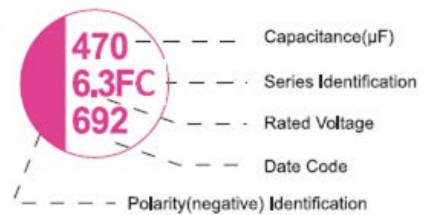

尺寸代码	Φ D x L	P	Φ d	a
C07	5x7	2.0	0.5	1.5
D09	5x9	2.5	0.5	1.0
E01	6.3x5.4	2.5	0.45	1.0
E06	6.3x6	2.5	0.5	1.5
E08	6.3x8	2.5	0.6	1.0
E11	6.3x11	2.5	0.5	1.0
G08	8x8	3.5	0.6	1.0
G1B	8x11.5	3.5	0.6	1.0
G15	8x15	3.5	0.6	1.5
H1A	10x10.5	5.0	0.6	1.0
H1C	10x12.5	5.0	0.6	1.0
H16	10x16	5.0	0.6	1.0

Multiplier for Ripple Current

Frequency(HZ)	120 ≤ F < 1K	1K ≤ F < 10K	10K ≤ F < 100K	100K ≤ F ≤ 500K
Coefficient	0.05	0.30	0.70	1.00

Jamicon Series : FC

Teapo Series : FC

■Dimensions, Rated Ripple Current, Equivalent Series Resistance

Rated (Surge) Voltage(V)	Capacitance (μ F)	SIZE Φ D x L (mm)	RIPPLE (mA/rms, 105°C 100KHz)	ESR (m Ω , 20°C 100KHz)
6.3 (7.25)	270	5x7	2500	25
	330	6.3x5.4	1500	45
	560	6.3x8	3000	20
	1000	6.3x11	3500	20
	820	8x8	4000	20
	1500	8x11.5	4500	15
10 (11.5)	2200	10x12.5	5000	15
	220	5x7	1800	25
	330	6.3x8	2500	30
	680	8x11.5	4500	20
16 (18.4)	1500	10x12.5	5000	20
	100	5x7	1600	35
	180	6.3x6	1800	45
	330	5x9	2400	40
	470	8x11.5	3500	20
25 (28.75)	1000	10x12.5	4000	20
	100	6.3x8	1200	45
	220	6.3x11	1800	35
	330	8x11.5	2000	40
	680	8x15	2200	40
80 (92.00)	1000	10x16	2800	35

Rated (Surge) Voltage(V)	Capacitance (μ F)	SIZE Φ D x L (mm)	RIPPLE (mA/rms, 105°C 100KHz)	ESR (m Ω , 20°C 100KHz)
35 (40.25)	100	6.3x8	1200	50
		8x8	1500	60
	220	8x11.5	1700	55
	330	10x12.5	2500	40
	680	10x16	3000	35
50 (57.5)	22	6.3x8	1100	60
	47	8x11.5	1500	50
	68	8x11.5	1500	50
		10x12.5	1800	40
	100	10x12.5	2200	40
63 (72.45)	220	10x16	2800	35
	22	6.3x8	900	90
	47	8x8	1100	65
	82	10x10.5	1200	65
	100	10x12.5	2000	50
80 (92.00)	180	10x16	2800	30
	47	10x12.5	1300	60
	100	10x16	2100	40

Jamicon Series : FB

Teapo Series : FB Long Life 20000hrs Series

- Endurance: 105°C,20000hrs
- Recommended Applications:Long Life 20000hrs Series
- Corresponding product to RoHS



■ Specifications

Item	Characteristics	
Category Temperature Range	-55 ~ +105°C	
Rated Voltage Range	6.3~80VDC	
Rated Capacitance Range	10~2200 μF	
Capacitance Tolerance	± 20 % (120Hz , 20°C)	
Surge Voltage	Rated voltage (V) x 1.15	
Leakage Current (20°C)	I ≤ 0.2CV or 300(μ A) whichever is greater(After rated voltage applied for 2 minutes) I : Leakage Current (μ A) C : Capacitance(μ F) V : Rated Voltage Range(VDC)	
Dissipation Factor (MAX) (tan δ) (120Hz ,20°C)	WV	6.3~80
	tan δ	0.12
Temperature characteristic Impedance ratio (MAX)	Z(100KHz) / WV	6.3 ~ 80V
	Z-25°C / Z+20°C	≤ 1.15
	Z-55°C / Z+20°C	≤ 1.25
Endurance	After applying rated voltage for 20000 hours at 105°C , the capacitor shall meet the following requirement °	
	Appearance	No significant damage
	Capacitance Change	Within ±20% of the initial value
	Dissipation Factor	Not more than 150% of the initial specified value
	Equivalent Series Resistance	Not more than 150% of the initial specified value
Humidity Test	after subjecting 90 to 95% RH for 1000 hours at 60°C , the capacitors shall meet the requirement as Endurance °	
	Surge voltage test After subjecting to 1000 cycles each consisting of charge with the surge voltage specified at normal temperature for 30 seconds through a protective resistor and discharge for 5 minutes 30 seconds,the capacitors shall meet the requirement as Endurance	
Failure rate(MAX)	0.5%per 1,000 hours(confidence level 60% at 105°C)	

■ Diagram of Dimensions

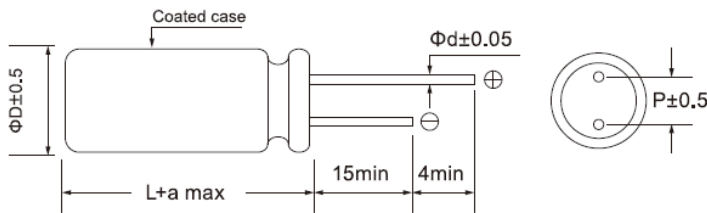

■ Marking : case with red printing

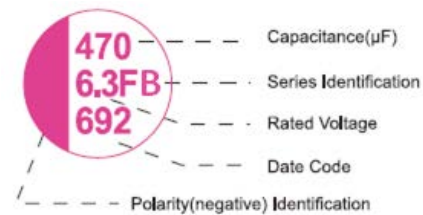

尺寸代码	ΦD x L	P	Φd	a
C07	5x7	2.0	0.5	1.5
E01	6.3x5.4	2.5	0.45	1.0
E08	6.3x8	2.5	0.6	1.0
E09	6.3x9	2.5	0.5	1.0
G08	8x8	3.5	0.6	1.0
G1B	8x11.5	3.5	0.6	1.0
H1A	10x10.5	5.0	0.6	1.0
H1C	10x12.5	5.0	0.6	1.0

■ Multiplier for Ripple Current

Frequency(HZ)	120 ≤ F < 1K	1K ≤ F < 10K	10K ≤ F < 100K	100K ≤ F ≤ 500K
Coefficient	0.05	0.30	0.70	1.00

Jamicon Series : FB

Teapo Series : FB

■Dimensions,Rated Ripple Current,Equivalent Series Resistance

Rated (Surge) Voltage(V)	Capacitance (μ F)	SIZE Φ D \times L(mm)	RIPPLE (mA/rms,105°C 100KHz)	ESR (m Ω ,20°C 100KHz)
6.3(7.25)	100	5x7	1500	35
	220	6.3x5.4	1300	50
	560	6.3x8	2800	25
	680	8x8	3500	25
	1000	8x11.5	4000	25
	1500	10x10.5	4200	20
	2200	10x12.5	5000	20
10 (11.5)	100	6.3x5.4	1800	40
	330	6.3x8	2300	35
	560	8x8	3500	35
	1000	8x11.5	4200	25
	1200	10x12.5	4800	25
16 (18.4)	220	6.3x8	2200	40
	330	6.3x9	2500	35
	470	8x11.5	3500	25
	560	8x11.5	3800	25
	820	10x12.5	4000	25
25 (28.75)	47	6.3x5.4	1000	90
	100	6.3x8	1500	50
	330	8x11.5	1700	45
		10x12.5	2000	45
		10x12.5	2200	45

Rated (Surge) Voltage(V)	Capacitance (μ F)	SIZE Φ D \times L(mm)	RIPPLE (mA/rms,105°C 100KHz)	ESR (m Ω ,20°C 100KHz)
35 (40.25)	47	6.3x8	1200	55
	100	8x8	1500	65
	220	8x11.5	1700	60
	270	10x12.5	2000	45
50 (57.5)	22	6.3x8	1100	65
	47	8x11.5	1500	50
	100	10x12.5	1800	50
63 (72.45)	10	6.3x8	700	100
	33	8x8	900	75
	82	10x12.5	1800	55
80 (92.00)	47	10x12.5	900	80

Jamicon Series : FT

Teapo Series : FT 125°C/2000hrs&Low ESR Series

- Endurance:125°C,2000hrs
- Recommended Applications: High temperature resistant products
- Corresponding product to RoHS



Specifications

Item	Characteristics	
Category Temperature Range	-55 ~ +125°C	
Rated Voltage Range	6.3~25VDC	
Rated Capacitance Range	10~ 1000 μF	
Capacitance Tolerance	± 20 % (120Hz , 20°C)	
Surge Voltage	Rated voltage (V) x 1.15	
Leakage Current (20°C)	I ≤ 0.2CV or 300(μA) whichever is greater (After rated voltage applied for 2 minutes) I : Leakage Current (μ A) C : Capacitance(μ F) V : Rated Voltage Range(VDC)	
Dissipation Factor (MAX) (tan δ) (120Hz ,20°C)	WV	6.3~25
	tan δ	0.12
Temperature characteristic Impedance ratio (MAX)	Z(100KHz) / WV	6.3 ~ 25V
	Z-25°C / Z+20°C	≤ 1.15
	Z-55°C / Z+20°C	≤ 1.25
Endurance	After applying rated voltage for 2000 hours at 125°C , the capacitor shall meet the following requirement °	
	Appearance	No significant damage
	Capacitance Change	Within ±20% of the initial value
	Dissipation Factor	Not more than 150% of the initial specified value
	Equivalent Series Resistance	Not more than 150% of the initial specified value
Humidity Test	after subjecting 90 to 95% RH for 1000 hours at 60°C , the capacitors shall meet the requirement as Endurance °	
	Surge voltage test	
Failure rate(MAX)	After subjecting to 1000 cycles each consisting of charge with the surge voltage specified at normal temperature for 30 seconds through a protective resistor and discharge for 5 minutes 30 seconds,the capacitors shall meet the requirement as Endurance	
	1%per 1,000 hours(confidence level 60% at 105°C)	

Diagram of Dimensions

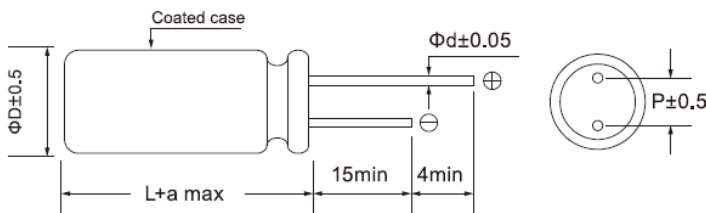

Marking : case with red printing

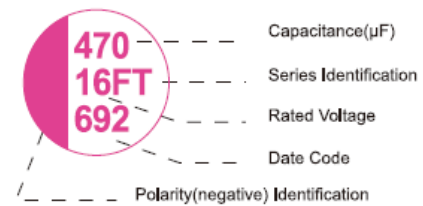

SIZE	Φ D x L	P	Φ d	a
E06	6.3x6	2.5	0.5	1.5
E08	6.3x8	2.5	0.5or0.6	1.0
G08	8x8	3.5	0.6	1.5
G1B	8x11.5	3.5	0.6	1.0
G15	8x15	3.5	0.6	1.5
H1C	10x12.5	5.0	0.6	1.0

Multiplier for Ripple Current

Frequency(HZ)	120 ≤ F < 1K	1K ≤ F < 10K	10K ≤ F < 100K	100K ≤ F ≤ 500K
Coefficient	0.05	0.30	0.70	1.00

Jamicon Series : FT

Teapo Series : FT 125°C/2000hrs&Low ESR Series

■Dimensions,Rated Ripple Current,Equivalent Series Resistance

Rated (Surge) Voltage(V)	Capacitance (μ F)	SIZE Φ DxL(mm)	RIPPLE(mA/rms,100kHz)		ESR (m Ω ,20°C 100kHz)	LC (μ A max/2min)
			T _x : 125°C	T _x : 105°C		
6.3 (7.2)	180	6.3x6	537	1700	45	300
	220	6.3x6	537	1700	45	300
	270	6.3x6	810	2560	45	340
	330	6.3x6	810	2560	45	415
	470	6.3x8	810	2560	35	592
		8x8	810	2560	15	592
	560	8x8	1332	4210	15	705
	680	8x8	1721	5440	15	856
820	8x8	1721	5440	15	1033	
1000	8x11.5	1721	5440	15	1260	
10 (11.5)	180	6.3x8	537	1700	45	360
	220	8x8	810	2560	35	440
	270	8x8	810	2560	35	540
	330	6.3x8	537	1700	45	660
		8x8	810	2560	35	660
	470	8x8	810	2560	35	940
	560	8x8	810	2560	35	1120
680	8x11.5	1332	4210	15	1360	
16 (18.4)	82	6.3x8	512	1620	50	300
	100	6.3x8	512	1620	50	320
	120	6.3x8	670	2120	50	384
	150	6.3x8	670	2120	50	480
	180	8x8	1151	3640	20	576
	220	8x8	1151	3640	20	704
	270	8x11.5	1493	4720	20	864
		8x11.5	1151	3640	20	1056
	330	10x12.5	1493	4720	16	1056
470	10x12.5	1493	4720	16	1504	
20(23)	47	6.3x8	458	1450	60	300
	56	6.3x8	598	1890	60	300
	68	6.3x8	598	1890	60	300
	82	6.3x8	1050	3320	60	328
	100	8x11.5	1050	3320	24	400
	120	8x11.5	1367	4320	24	480
	150	8x11.5	1367	4320	24	600
25(28.75)	10	6.3x8	458	1450	60	300
	22	6.3x8	458	1450	60	300
	33	6.3x8	458	1450	60	300
	47	6.3x8	598	1890	60	300
	56	6.3x8	598	1890	60	300
	68	6.3x8	1050	3320	60	340
	82	6.3x8	1050	3320	60	410
	100	8x11.5	1050	3320	24	500
		10x12.5	1367	4320	20	500
	150	8x11.5	1367	4320	24	750
	220	8x11.5	1050	3320	24	1100
	270	8x15	1367	4320	20	1350
330	10x12.5	1367	4320	20	1650	

Jamicon Series : YA

Teapo Series : YA Standard Series



- Endurance:105°C,2000hrs
- Recommended Applications: Standard SMD type product
- Corresponding product to RoHS

Specifications

Item	Characteristics		
Category Temperature Range	-55 ~ +105°C		
Rated Voltage Range	16~25VDC		
Rated Capacitance Range	47~ 470 μF		
Capacitance Tolerance	± 20 % (120Hz , 20°C)		
Surge Voltage	Rated voltage (V) x 1.15		
Leakage Current (20°C)	I ≤ 0.01CV or 3 (μ A) whichever is greater (After rated voltage applied for 2 minutes) I : Leakage Current (μ A) C : Capacitance(μ F) V : Rated Voltage Range(VDC)		
Dissipation Factor (MAX) (tan δ) (120Hz ,20°C)	WV	16	25
	tan δ	0.16	0.14
Temperature characteristic Impedance ratio (MAX)	Z(100KHz) \ WV	16~ 25V	
	Z-25°C / Z+20°C	≤ 1.15	
	Z-55°C / Z+20°C	≤ 1.25	
Endurance	After applying rated voltage for 2000 hours at 105°C , the capacitor shall meet the following requirement °		
	Appearance	No significant damage	
	Capacitance Change	Within ±20% of the initial value	
	Dissipation Factor	Not more than 150% of the initial specified value	
	Equivalent Series Resistance	Not more than 150% of the initial specified value	
Humidity Test	after subjecting 90 to 95% RH for 1000 hours at 60°C , the capacitors shall meet the requirement as Endurance °		
	Capacitance Change	Within ±10% of the initial value	
	Dissipation Factor	Not more than 130% of the initial specified value	
	Equivalent Series Resistance	Not more than 130% of the initial specified value	
	Leakage Current	Not more than the initial specified value	
Resistance to Soldering Heat *	Capacitance Change	Within ±10% of the initial value	
	Dissipation Factor	Not more than 130% of the initial specified value	
	Equivalent Series Resistance	Not more than 130% of the initial specified value	
	Leakage Current	Not more than the initial specified value	

*For any doubt about measured values, measure the leakage current again after the following voltage treatment °
Voltage treatment: Applying DC rated voltage to the capacitors for 2 hours at 105°C °

Diagram of Dimensions

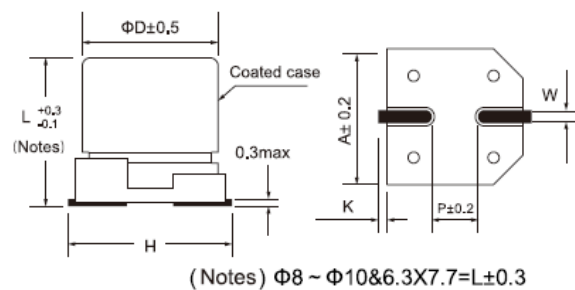

Marking : case with red printing

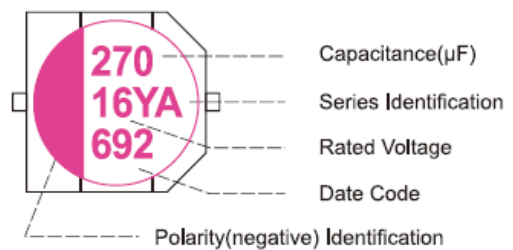

SIZE	Φ D x L	A	H(Max)	W	P	K
EA4	6.3x7.7	6.6	7.8	0.65±0.15	1.8±0.2	0.35+0.15/-0.2
GA6	8x10.4	8.3	10	0.9±0.2	3.1±0.2	0.7±0.2
HA5	10x10.2	10.3	12	0.9±0.2	4.6±0.2	0.7±0.2

Multiplier for Ripple Current

Frequency(HZ)	120 ≤ F < 1K	1K ≤ F < 10K	10K ≤ F < 100K	100K ≤ F ≤ 500K
Coefficient	0.05	0.30	0.70	1.00

Jamicon Series : YA

Teapo Series : YA

Standard Series

■Dimensions, Rated Ripple Current, Equivalent Series Resistance

Rated (Surge) Voltage(V)	Capacitance (μ F)	SIZE Φ DxL(mm)	RIPPLE (mA/rms, 105 °C 100KHz)	ESR (m Ω , 20°C 100KHz)	LC (μ A max/2min)
16 (18.4)	150	6.3X7.7	1600	45	24
	270	8X10.4	1800	40	43.2
	470	10X10.2	2000	30	75.2
25 (28.75)	100	6.3X7.7	1600	45	25
	180	8X10.4	1800	40	45
	270	10X10.2	2000	30	67.5

Jamicon Series : YX

Teapo Series : YX Standard Series

- Endurance:105°C,2000hrs
- Recommended Applications: standard
- Corresponding product to RoHS



■ Specifications

Item	Characteristics			
Category Temperature Range	-55 ~ +105°C			
Rated Voltage Range	16~35VDC			
Rated Capacitance Range	47~ 470 μF			
Capacitance Tolerance	± 20 % (120Hz , 20°C)			
Surge Voltage	Rated voltage (V) x 1.15			
Leakage Current (20°C)	I ≤ 0.01CV or 3 (μ A) whichever is greater (After rated voltage applied for 2 minutes) I : Leakage Current (μ A) C : Capacitance(μ F) V : Rated Voltage Range(VDC)			
Dissipation Factor (MAX) (tan δ) (120Hz ,20°C)	WV	16	25	35
	tan δ	0.16	0.14	0.12
Temperature characteristic Impedance ratio (MAX)	WV		16 ~ 35V	
	Z(100KHz)			
	Z-25°C / Z+20°C	≤ 1.15		
	Z-55°C / Z+20°C	≤ 1.25		
Endurance	After applying rated voltage for 2000 hours at 105°C , the capacitor shall meet the following requirement °			
	Appearance	No significant damage		
	Capacitance Change	Within ±20% of the initial value		
	Dissipation Factor	Not more than 150% of the initial specified value		
	Equivalent Series Resistance	Not more than 150% of the initial specified value		
	Leakage Current	Not more than the initial specified value		
Humidity Test	after subjecting 90 to 95% RH for 1000 hours at 60°C , the capacitors shall meet the requirement as Endurance °			
Surge voltage test	After subjecting to 1000 cycles each consisting of charge with the surge voltage specified at normal temperature for 30 seconds through a protective resistor and discharge for 5 minutes 30 seconds,the capacitors shall meet the requirement as Endurance			
Failure rate(MAX)	1%per 1,000 hours(confidence level 60% at 105°C)			

■ Diagram of Dimensions

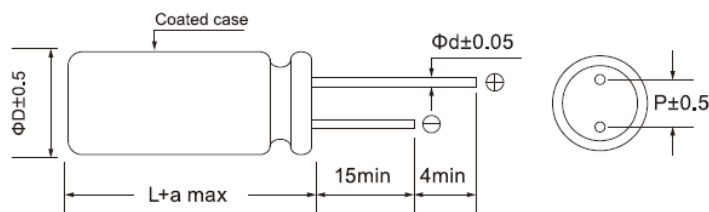

■ Marking : case with red printing

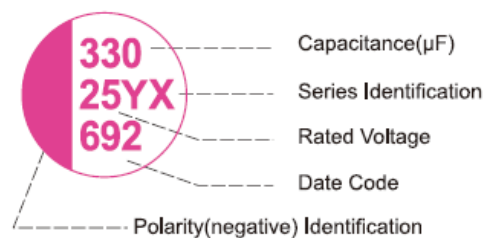

SIZE	Φ D x L	P	φ d	a
E08	6.3x8	2.5	0.6	1.0
G1B	8x11.5	3.5	0.6	1.0
H1C	10x12.5	5.0	0.6	1.0

■ Multiplier for Ripple Current

Frequency(HZ)	120 ≤ F < 1K	1K ≤ F < 10K	10K ≤ F < 100K	100K ≤ F ≤ 500K
Coefficient	0.05	0.30	0.70	1.00

Jamicon Series : YX

Teapo Series : YX

■Dimensions, Rated Ripple Current, Equivalent Series Resistance

Rated (Surge) Voltage(V)	Capacitance (μ F)	SIZE Φ D \times L(mm)	RIPPLE (mA/rms, 105°C 100KHz)	ESR (m Ω , 20°C 100KHz)	LC (μ A max/2min)
16 (18.4)	220	6.3Xx8	1600	45	35.2
	270	8x11.5	1800	40	43.2
	470	10x12.5	2000	30	75.2
25 (28.75)	100	6.3x8	1600	45	25
	220	8x11.5	1800	40	55
	330	10x12.5	2000	30	82.5
35 (40.25)	68	6.3x8	1600	45	23.8
	150	8x11.5	1800	40	52.5
	270	10x12.5	2000	30	94.5

Jamicon Series : CS

Teapo Series : GV

General purpose Series

■ Endurance:85°C, 2000 hours

■ Recommended Applications: Suitable for AV(TV,Video,Audio),Monitor/Computer, Home appliance, OA/HA/Comm

■ Corresponding product to RoHS



Jamicon

Teapo

■ Specifications

Item	Characteristics																																								
Category Temperature Range	-55 ~ +85°C																																								
Rated Voltage Range	4 ~ 100VDC																																								
Rated Capacitance Range	1 ~ 1500 μF																																								
Capacitance Tolerance	± 20 % at 120Hz, 20°C																																								
Leakage Current (20°C)	I ≤ 0.01CV or 3 μA, whichever is greater. (After rated voltage applied for 2 minutes) I : Max. leakage current (μA), C : Nominal capacitance (μF), V : Rated voltage (V)																																								
Dissipation Factor(MAX) (tan δ) (120Hz, 20°C)	Shown in the table of standard rating																																								
Low Temperature Stability Impedance Ratio (MAX)	<table border="1"> <thead> <tr> <th>WV</th> <th>4</th> <th>6.3</th> <th>10</th> <th>16</th> <th>25</th> <th>35</th> <th>50</th> <th>63</th> <th>100</th> </tr> </thead> <tbody> <tr> <td>Z(120HZ)</td> <td></td> <td></td> <td></td> <td></td> <td></td> <td></td> <td></td> <td></td> <td></td> </tr> <tr> <td>Z(-25°C) / Z(20°C)</td> <td>7</td> <td>4</td> <td>3</td> <td>2</td> <td>2</td> <td>2</td> <td>2</td> <td>2</td> <td>2</td> </tr> <tr> <td>Z(-40°C) / Z(20°C)</td> <td>15</td> <td>8</td> <td>6</td> <td>4</td> <td>4</td> <td>3</td> <td>3</td> <td>3</td> <td>3</td> </tr> </tbody> </table>	WV	4	6.3	10	16	25	35	50	63	100	Z(120HZ)										Z(-25°C) / Z(20°C)	7	4	3	2	2	2	2	2	2	Z(-40°C) / Z(20°C)	15	8	6	4	4	3	3	3	3
WV	4	6.3	10	16	25	35	50	63	100																																
Z(120HZ)																																									
Z(-25°C) / Z(20°C)	7	4	3	2	2	2	2	2	2																																
Z(-40°C) / Z(20°C)	15	8	6	4	4	3	3	3	3																																
Endurance	After applying rated voltage for 2000hrs at 85°C, Stay back to 20 °C temp: (Notes) Φ8 ~ Φ10&6.3X7.7=L±0.3 meet the following requirements. <table border="1"> <tr> <td>Capacitance Change</td> <td>Within ±20% of the initial value</td> </tr> <tr> <td>Dissipation Factor</td> <td>Not more than 200% of the specified value</td> </tr> <tr> <td>Leakage Current</td> <td>Not more than the specified value</td> </tr> </table>	Capacitance Change	Within ±20% of the initial value	Dissipation Factor	Not more than 200% of the specified value	Leakage Current	Not more than the specified value																																		
Capacitance Change	Within ±20% of the initial value																																								
Dissipation Factor	Not more than 200% of the specified value																																								
Leakage Current	Not more than the specified value																																								
Shelf Life	The following specifications shall be satisfied when the capacitors are restored to 20°C after exposing them for 1,000 hours at 85°C without voltage applied. Before the measurement, the capacitor shall be preconditioned by applying voltage according to item 4.1 of JIS C 5101-4.																																								

■ MARKING

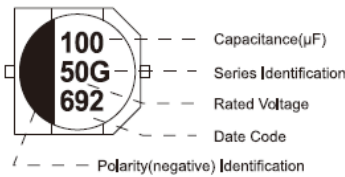

Teapo

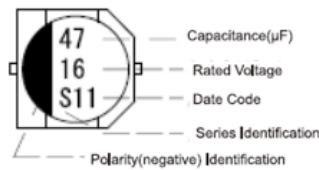

Jamicon

■ Dimensions [mm]

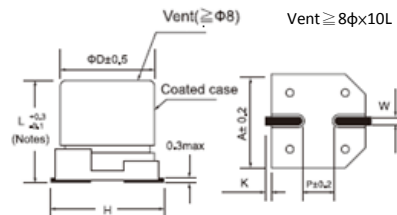

(Notes) Φ8 ~ Φ10&6.3X7.7=L±0.3

Dimensions	ΦD	L	A	H	W	P	K
B01	4.0	5.4	4.3	5.5 Max	0.65±0.1	1.0	0.35+0.15/-0.2
C01	5.0	5.4	5.3	6.5 Max	0.65±0.1	1.5	0.35+0.15/-0.2
E01	6.3	5.4	6.6	7.8 Max	0.65±0.1	2.1	0.35+0.15/-0.2
E04	6.3	7.7	6.6	7.8 Max	0.65±0.1	2.1	0.35+0.15/-0.2
G02	8.0	6.2	8.3	9.5 Max	0.65±0.1	2.2	0.35+0.15/-0.2
G03	8.0	10.2	8.3	10.0 Max	0.90±0.2	3.1	0.70±0.20
H03	10.0	10.2	10.3	12.0 Max	0.90±0.2	4.6	0.70±0.20

■ Multiplier for Ripple Current

Frequency (Hz)	60	120	1K	10K
Coefficient	0.80	1.00	1.15	1.25

Jamicon Series : CS

Teapo Series : GV

■ STANDARD RATINGS

Rated Voltage (Surge Voltage) (V)	Cap (μF)	Case size Φ D x L (mm)	tan δ	Ripple current (mA/rms 85°C) (120Hz)	Rated Voltage (Surge Voltage) (V)	Cap (μF)	Case size Φ D x L (mm)	tan δ	Ripple current (mA/rms 85°C) (120Hz)	
4(5)	33	4x5.4	0.35	26	25(32)	10	4x5.4	0.14	24	
	47	4x5.4	0.35	34			5x5.4	0.14	28	
	100	5x5.4	0.35	61			6.3x5.4	0.14	28	
	220	6.3x5.4	0.35	82			22	5x5.4	0.14	35
	330	6.3x5.4	0.35	80				6.3x5.4	0.14	55
	470	6.3x7.7	0.35	200			33	5x5.4	0.14	42
6.3(8)	22	4x5.4	0.26	20		6.3x5.4		0.14	65	
	33	4x5.4	0.26	22		47	6.3x5.4	0.14	70	
		4x5.4	0.26	36			6.3x7.7	0.14	96	
	100	5x5.4	0.26	46			8x6.2	0.14	100	
		5x5.4	0.26	47		100	6.3x5.4	0.14	80	
		6.3x5.4	0.26	71			6.3x7.7	0.14	143	
	6.3x7.7	0.26	143	8x6.2			0.14	143		
	220	6.3x5.4	0.26	74		8x10.2	0.14	180		
		6.3x7.7	0.26	235		180	8x10.2	0.14	210	
	330	6.3x7.7	0.26	280			220	8x10.2	0.14	230
		8x6.2	0.26	280		10x10.2		0.14	310	
	470	8x6.2	0.26	312		330	8x10.2	0.14	270	
		8x10.2	0.26	380	10x10.2		0.14	340		
	1000	8x10.2	0.26	500	470	10x10.2	0.14	380		
		10x10.2	0.26	700		35(44)	2.2	4x5.4	0.12	8
1500	10x10.2	0.26	750	3.3	4x5.4		0.12	10		
10(13)	10	4x5.4	0.20	20	5x5.4		0.12	11		
	22	4x5.4	0.20	28	4.7		4x5.4	0.12	22	
		5x5.4	0.20	40	10		4x5.4	0.12	24	
	33	4x5.4	0.20	29			5x5.4	0.12	30	
		5x5.4	0.20	43	22		5x5.4	0.12	36	
	47	5x5.4	0.20	43			6.3x5.4	0.12	60	
		6.3x5.4	0.20	66	33		6.3x5.4	0.12	60	
	100	5x5.4	0.20	43			6.3x7.7	0.12	130	
		6.3x5.4	0.20	70	47		6.3x5.4	0.12	70	
	150	6.3x5.4	0.20	86			6.3x7.7	0.12	165	
		6.3x5.4	0.20	110			8x6.2	0.12	165	
	220	6.3x7.7	0.20	250	100		6.3x7.7	0.12	140	
		8x6.2	0.20	250			8x10.2	0.12	180	
	330	8x10.2	0.20	330	220	10x10.2	0.12	210		
		8x10.2	0.20	390		8x10.2	0.12	200		
	470	10x10.2	0.20	400	10x10.2	0.12	310			
		680	8x10.2	0.20	420	150	8x10.2	0.12	180	
	1000		10x10.2	0.20	580	330	10x10.2	0.12	350	
16(20)	1	4x5.4	0.16	10	50(63)	1	4x5.4	0.12	10	
	4.7	4x5.4	0.16	20		2.2	4x5.4	0.12	16	
	10	4x5.4	0.16	28		3.3	4x5.4	0.12	16	
		5x5.4	0.16	28		4.7	4x5.4	0.12	18	
	22	4x5.4	0.16	28			5x5.4	0.12	23	
		5x5.4	0.16	39		10	5x5.4	0.12	27	
	33	4x5.4	0.16	30			6.3x5.4	0.12	36	
		5x5.4	0.16	45		22	6.3x5.4	0.12	40	
	6.3x5.4	0.16	66	6.3x7.7			0.12	90		
	47	5x5.4	0.16	45		33	6.3x7.7	0.12	90	
		6.3x5.4	0.16	70			8x6.2	0.12	130	
		8x6.2	0.16	85			8x10.2	0.12	150	
	100	6.3x5.4	0.16	70		47	6.3x7.7	0.12	90	
		6.3x7.7	0.16	85			8x6.2	0.12	100	
		8x6.2	0.16	140			8x10.2	0.12	190	
	220	6.3x7.7	0.16	162	56	8x10.2	0.12	130		
		8x10.2	0.16	280		100	8x10.2	0.12	200	
	330	8x10.2	0.16	320	220		10x10.2	0.12	310	
		10x10.2	0.16	380		10x10.2	0.12	460		
	470	8x10.2	0.16	350	63(79)	4.7	5x5.4	0.12	20	
		10x10.2	0.16	420		10	6.3x5.4	0.12	20	
680	10x10.2	0.16	500	22		6.3x7.7	0.12	40		
25(32)	4.7	4x5.4	0.14	22						

Jamicon Series : CS

Teapo Series : GV

■ STANDARD RATINGS

Rated Voltage (SurageVoltage) (V)	Cap (μ F)	Case size Φ DxL(mm)	$\tan \delta$ (%)	Ripple current (mA/rms 85°C) (120Hz)	Rated Voltage (SurageVoltage) (V)	Cap (μ F)	Case size Φ DxL(mm)	$\tan \delta$ (%)	Ripple current (mA/rms 85°C) (120Hz)
63(79)	22	8x6.2	0.12	95	100(125)	4.7	6.3x7.7	0.10	50
		8x10.2	0.12	120			8x10.2	0.10	60
	33	8x10.2	0.12	140		10	6.3x7.7	0.10	50
		47	8x10.2	0.12			170	8X10.2	0.10
	100		10x10.2	0.12		190	22	8X10.2	0.10
		10x10.2	0.12	280		10X10.2		0.10	150
100(125)	3.3	6.3X7.7	0.10	50		33	10X10.2	0.10	180
	4.7	6.3x5.4	0.10	40		47	10x10.2	0.10	210

Jamicon Series : CT

Teapo Series : SV

General purpose Series

■ Endurance:105°C, 1000 hours

■ Recommended Applications: Suitable for AV(TV,Video,Audio),Monitor/Computer, Home appliance, OA/HA/Comm

■ Corresponding product to RoHS



Jamicon



Teapo

■ Specifications

Item	Characteristics																																								
Category Temperature Range	-55 ~ +105°C																																								
Rated Voltage Range	4 ~ 100VDC																																								
Rated Capacitance Range	1 ~ 1500 μF																																								
Capacitance Tolerance	± 20 % at 120Hz, 20°C																																								
Leakage Current (20°C)	$I \leq 0.01CV$ or $3 \mu A$, whichever is greater. (After rated voltage applied for 2 minutes) I : Max. leakage current (μA), C : Nominal capacitance (μF), V : Rated voltage (V)																																								
Dissipation Factor(MAX) (tan δ) (120Hz, 20°C)	Shown in the table of standard rating																																								
Low Temperature Stability Impedance Ratio (MAX)	<table border="1"> <thead> <tr> <th>WV</th> <th>4</th> <th>6.3</th> <th>10</th> <th>16</th> <th>25</th> <th>35</th> <th>50</th> <th>63</th> <th>100</th> </tr> </thead> <tbody> <tr> <td>Z(120HZ)</td> <td></td> <td></td> <td></td> <td></td> <td></td> <td></td> <td></td> <td></td> <td></td> </tr> <tr> <td>Z(-25°C) / Z(20°C)</td> <td>7</td> <td>4</td> <td>3</td> <td>2</td> <td>2</td> <td>2</td> <td>2</td> <td>2</td> <td>2</td> </tr> <tr> <td>Z(-40°C) / Z(20°C)</td> <td>15</td> <td>8</td> <td>6</td> <td>4</td> <td>4</td> <td>3</td> <td>3</td> <td>3</td> <td>3</td> </tr> </tbody> </table>	WV	4	6.3	10	16	25	35	50	63	100	Z(120HZ)										Z(-25°C) / Z(20°C)	7	4	3	2	2	2	2	2	2	Z(-40°C) / Z(20°C)	15	8	6	4	4	3	3	3	3
WV	4	6.3	10	16	25	35	50	63	100																																
Z(120HZ)																																									
Z(-25°C) / Z(20°C)	7	4	3	2	2	2	2	2	2																																
Z(-40°C) / Z(20°C)	15	8	6	4	4	3	3	3	3																																
Endurance	After applying rated voltage for 1000hrs at 105°C, Stay back to 20 °C temperature measurement, the capacitors shall meet the following requirements. <table border="1"> <tr> <td>Capacitance Change</td> <td>Within ±20% of the initial value</td> </tr> <tr> <td>Dissipation Factor</td> <td>Not more than 200% of the specified value</td> </tr> <tr> <td>Leakage Current</td> <td>Not more than the specified value</td> </tr> </table>	Capacitance Change	Within ±20% of the initial value	Dissipation Factor	Not more than 200% of the specified value	Leakage Current	Not more than the specified value																																		
Capacitance Change	Within ±20% of the initial value																																								
Dissipation Factor	Not more than 200% of the specified value																																								
Leakage Current	Not more than the specified value																																								
Shelf Life	The following specifications shall be satisfied when the capacitors are restored to 20°C after exposing them for 1,000 hours at 105°C without voltage applied. Before the measurement, the capacitor shall be preconditioned by applying voltage according to item 4.1 of JIS C 5101-4.																																								

■ MARKING

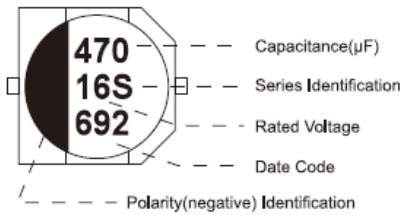

Teapo

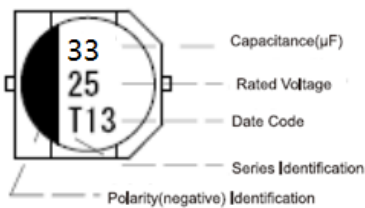

Jamicon

■ Dimensions [mm]

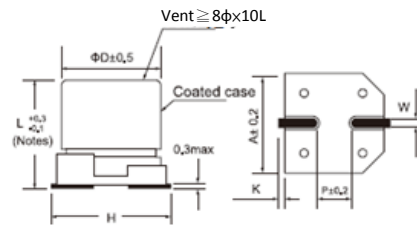

(Notes) Φ8 ~ Φ10&6.3X7.7=L±0.3

Dimensions	ΦD	L	A	H	W	P	K
B01	4.0	5.4	4.3	5.5 Max	0.65±0.1	1.0	0.35+0.15/-0.2
C01	5.0	5.4	5.3	6.5 Max	0.65±0.1	1.5	0.35+0.15/-0.2
E01	6.3	5.4	6.6	7.8 Max	0.65±0.1	2.1	0.35+0.15/-0.2
E04	6.3	7.7	6.6	7.8 Max	0.65±0.1	2.1	0.35+0.15/-0.2
G03	8.0	10.2	8.3	10.0 Max	0.90±0.2	3.1	0.70±0.20
H03	10.0	10.2	10.3	12.0 Max	0.90±0.2	4.6	0.70±0.20

■ Multiplier for Ripple Current

Frequency (Hz)	60	120	1K	10K
Coefficient	0.85	1.00	1.15	1.25

Jamicon Series : CT

Teapo Series : SV

■ STANDARD RATINGS

Rated Voltage (Surge Voltage) (V)	Cap (μF)	Case size Φ DxL(mm)	tan δ	Ripple current (mA/rms 105°C) (120Hz)	Rated Voltage (Surge Voltage) (V)	Cap (μF)	Case size Φ DxL(mm)	tan δ	Ripple current (mA/rms 105°C) (120Hz)	
4(5)	22	4x5.4	0.35	20	25(32)	22	6.3x5.4	0.14	55	
	33	4x5.4	0.35	26		33	5x5.4	0.14	45	
	47	4x5.4	0.35	34		47	6.3x5.4	0.14	65	
	100	5x5.4	0.35	61			6.3x5.4	0.14	71	
	220	6.3x5.4	0.35	82		100	6.3x7.7	0.14	91	
6.3(8)	22	4x5.4	0.30	29			6.3x7.7	0.14	95	
	33	4x5.4	0.30	43			220	8x10.2	0.16	140
	47	4x5.4	0.30	43		8x10.2		0.16	200	
	47	5x5.4	0.30	46		330	10x10.2	0.16	273	
		5x5.4	0.30	47			8x10.2	0.16	250	
	100	6.3x5.4	0.30	71	470	10x10.2	0.16	340		
		6.3x5.4	0.30	74		10x10.2	0.16	360		
	6.3(8)	6.3x7.7	0.30	120	35(44)	2.2	4x5.4	0.12	15	
		330	6.3x7.7	0.30		175	3.3	4x5.4	0.12	18
		470	8x10.2	0.35		230	4.7	4x5.4	0.12	22
8x10.2			0.35	300		10	4x5.4	0.12	25	
1000		8x10.2	0.35	300			5x5.4	0.12	30	
		10x10.2	0.35	400		22	5x5.4	0.12	35	
1500		10x10.2	0.35	480			6.3x5.4	0.12	60	
		10(13)	10	4x5.4		0.22	24	33	6.3x5.4	0.12
22	4x5.4		0.22	36		47	6.3x7.7		0.12	84
33	4x5.4		0.22	45			6.3x5.4	0.12	60	
	5x5.4		0.22	46	6.3x7.7	0.12	84			
47	5x5.4		0.22	46	100	8x10.2	0.14	100		
	6.3x5.4		0.22	70		6.3x7.7	0.14	105		
100	6.3x5.4		0.22	71	220	8x10.2	0.14	150		
	6.3x7.7		0.22	110		8x10.2	0.14	220		
150	6.3x5.4		0.22	86	330	10x10.2	0.14	250		
	6.3x7.7		0.22	115		10x10.2	0.14	300		
220	8x10.2	0.26	160	50(63)	1	4x5.4	0.12	10		
330	8x10.2	0.26	200		2.2	4x5.4	0.12	16		
	8x10.2	0.26	230		3.3	4x5.4	0.12	16		
470	10x10.2	0.26	270		4.7	5x5.4	0.12	23		
	10x10.2	0.26	390		10	6.3x5.4	0.12	35		
16(20)	4.7	4x5.4	0.16		20	22	6.3x7.7	0.12	65	
	10	4x5.4	0.16		28		33	6.3x7.7	0.12	70
	22	4x5.4	0.16		28	8x10.2		0.12	91	
		5x5.4	0.16		39	47	6.3x7.7	0.12	75	
	5x5.4	0.16	39		8x10.2		0.12	95		
	33	6.3x5.4	0.16	65	100	8x10.2	0.12	110		
		5x5.4	0.16	39		10x10.2	0.12	145		
	47	6.3x5.4	0.16	70	220	10x10.2	0.12	210		
		6.3x5.4	0.16	80	63(79)	4.7	6.3x5.4	0.18	20	
	100	6.3x7.7	0.16	130		10	6.3x5.4	0.18	20	
6.3x7.7		0.16	105	22		8x10.2	0.18	30		
220	8x10.2	0.20	180	33		8x10.2	0.18	30		
	8x10.2	0.20	220	47		8x10.2	0.18	45		
330	10x10.2	0.20	260	100	10x10.2	0.18	60			
	8x10.2	0.20	270	100(125)	3.3	8x10.2	0.18	30		
470	10x10.2	0.20	340		4.7	8x10.2	0.18	50		
	680	10x10.2	0.20		380	10	8x10.2	0.18	55	
25(32)	4.7	4x5.4	0.14		22	22	10x10.2	0.18	60	
	10	4x5.4	0.14		22	33	10x10.2	0.18	65	
		5x5.4	0.14	28	47	10x10.2	0.18	65		
	22	5x5.4	0.14	35						

Jamicon Series : CH

Teapo Series : DV

General purpose 、 High voltage purpose

■ Endurance: 105°C, 2000 hours

■ Recommended Applications: Suitable for AV(TV, Video, Audio), Monitor/Computer, Home appliance, OA/HA/Communication, Industrial, Automobile, Meter.

■ Corresponding product to RoHS



Jamicon

Teapo

Specifications

Item	Characteristics																																		
Category Temperature Range	-55 ~ +105°C	-25 ~ +105°C																																	
Rated Voltage Range	6.3 ~ 100VDC	160 ~ 450VDC																																	
Rated Capacitance Range	1 ~ 2200 μF																																		
Capacitance Tolerance	± 20 % (120Hz, 20°C)																																		
Leakage Current (20°C)	4~10Φ	12.5~16Φ																																	
	I ≤ 0.01CV or 3(μA), whichever is greater. I ≤ 0.03CV or 4(μA), whichever is greater.																																		
	(After rated voltage applied for 2 minutes) (After rated voltage applied for 5 minutes)																																		
I = Leakage Current (μA) C = Nominal Capacitance (μF) V = Rated Voltage (V)																																			
Dissipation Factor(MAX) (tan δ) (120Hz, 20°C)	Shown in the table of standard ratings																																		
Low Temperature Stability Impedance Ratio (MAX)	<table border="1"> <thead> <tr> <th>WV</th> <th>6.3</th> <th>10</th> <th>16</th> <th>25</th> <th>35~100</th> <th>160~450</th> </tr> </thead> <tbody> <tr> <td>Z(120HZ)</td> <td></td> <td></td> <td></td> <td></td> <td></td> <td></td> </tr> <tr> <td>Z(-25°C) / Z(20°C)</td> <td>4</td> <td>3</td> <td>2</td> <td>2</td> <td>2</td> <td>4</td> </tr> <tr> <td>Z(-40°C) / Z(20°C)</td> <td>8</td> <td>6</td> <td>4</td> <td>4</td> <td>3</td> <td>—</td> </tr> </tbody> </table>							WV	6.3	10	16	25	35~100	160~450	Z(120HZ)							Z(-25°C) / Z(20°C)	4	3	2	2	2	4	Z(-40°C) / Z(20°C)	8	6	4	4	3	—
	WV	6.3	10	16	25	35~100	160~450																												
	Z(120HZ)																																		
	Z(-25°C) / Z(20°C)	4	3	2	2	2	4																												
Z(-40°C) / Z(20°C)	8	6	4	4	3	—																													
Endurance	After applying rated voltage for 2000hrs at 105°C, Stay back to 20 °C temperature measurement, the capacitors shall meet the following requirements.																																		
	Case (Φ)	4~6.3Φ				8~16Φ																													
	Capacitance Change	Within ±25% of the initial value				Within ±20% of the initial value																													
	Dissipation Factor	Not more than 200% of the specified value																																	
	Leakage Current	Not more than the specified value																																	
Shelf Life	The following specifications shall be satisfied when the capacitors are restored to 20°C after exposing them for 1,000 hours at 105°C without voltage applied. Before the measurement, the capacitor shall be preconditioned by applying voltage according to item 4.1 of JIS C 5101-4.																																		

MARKING

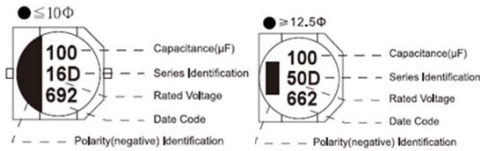

Teapo

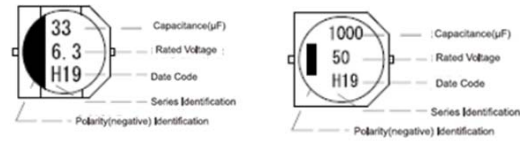

Jamicon

Dimensions

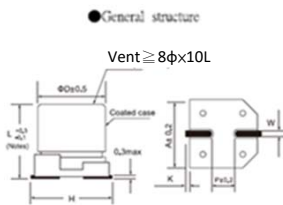

Φ12.5=L±1.0

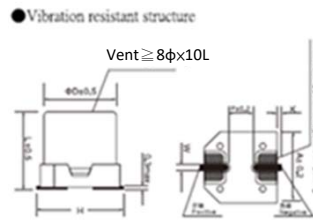

(Notes) Φ12.5=L±1.0

Dimensions	ΦD	L	A	H	W	P	K
B01	4.0	5.4	4.3	5.5 Max	0.65±0.1	1.0	0.35+0.15/-0.2
C01	5.0	5.4	5.3	6.5 Max	0.65±0.1	1.5	0.35+0.15/-0.2
E01	6.3	5.4	6.6	7.8 Max	0.65±0.1	2.1	0.35+0.15/-0.2
E04	6.3	7.7	6.6	7.8 Max	0.65±0.1	2.1	0.35+0.15/-0.2
G02	8.0	6.2	8.3	9.5 Max	0.65±0.1	2.2	0.35+0.15/-0.2
G03	8.0	10.2	8.3	10.0 Max	0.90±0.2	3.1	0.70±0.20
H03	10.0	10.2	10.3	12.0 Max	0.90±0.2	4.6	0.70±0.20
K05	12.5	13.5	13.0	15.0 Max	1.20±0.2	4.4	0.70±0.30
K06	12.5	16	13.0	15.0 Max	1.20±0.2	4.4	0.70±0.30
M06	16.0	16.5	17.0	19.0 Max	1.20±0.2	6.4	0.70±0.30

Multiplier for Ripple Current

Frequency (Hz)	60	120	1K	10K
Coefficient	0.85	1.00	1.15	1.25

Jamicon Series : CH

Teapo Series : DV

■ STANDARD RATINGS

Rated Voltage (Surge Voltage) (V)	Cap (μF)	Case size Φ D x L (mm)	tan δ	Ripple current (mA/rms 105°C) (120Hz)	Rated Voltage (Surge Voltage) (V)	Cap (μF)	Case size Φ D x L (mm)	tan δ	Ripple current (mA/rms 105°C) (120Hz)
6.3(8)	22	4x5.4	0.30	26	25(32)	47	6.3x7.7	0.14	91
	33	4x5.4	0.30	29		100	6.3x7.7	0.14	100
	47	4x5.4	0.30	31		8x6.2	0.16	100	
		5x5.4	0.30	46		8x10.2	0.16	230	
	100	5x5.4	0.30	47		8x10.2	0.16	270	
		6.3x5.4	0.30	71		10x10.2	0.16	310	
	220	6.3x5.4	0.30	80		8x10.2	0.16	290	
		6.3x7.7	0.30	120		10x10.2	0.16	380	
	330	6.3x7.7	0.30	140		470	10x10.2	0.16	380
		8x6.2	0.35	140		1000	12.5x13.5	0.26	510
		8x10.2	0.35	290		1500	12.5x16	0.26	590
	470	8x10.2	0.35	290		2200	16x16.5	0.26	900
		10x10.2	0.35	380		35(44)	4.7	4x5.4	0.12
	1000	8x10.2	0.35	290			6.8	4x5.4	0.12
10x10.2		0.35	410	10	5x5.4		0.12	30	
1500	10x10.2	0.35	460	22	5x5.4		0.12	35	
	12.5x13.5	0.35	680	33	6.3x5.4		0.12	60	
10(13)	10	4x5.4	0.22	20	33		6.3x7.7	0.12	80
	22	4x5.4	0.22	23	47		8x6.2	0.12	80
	33	4x5.4	0.22	26	6.3x5.4		0.12	60	
		5x5.4	0.22	45	6.3x7.7		0.12	100	
	47	5x5.4	0.22	60	8x10.2		0.14	210	
		6.3x5.4	0.22	70	100		6.3x7.7	0.12	105
	100	5x5.4	0.22	60	8x10.2		0.14	240	
		6.3x5.4	0.22	75	10x10.2		0.14	310	
		6.3x7.7	0.22	110	12.5x13.5		0.14	390	
	220	6.3x7.7	0.22	120	220	8x10.2	0.14	260	
		8x6.2	0.26	120	330	10x10.2	0.14	350	
	330	8x10.2	0.26	260	470	10x10.2	0.14	370	
		6.3x7.7	0.26	200	680	12.5x13.5	0.22	520	
	470	8x10.2	0.26	290	1000	12.5x13.5	0.22	590	
8x10.2		0.26	320	1500	16x16.5	0.22	800		
680	10x10.2	0.26	380	1000	16x16.5	0.22	1000		
1000	8x10.2	0.26	360	50(63)	1	4x5.4	0.12	10	
2200	10x10.2	0.26	410		2.2	4x5.4	0.12	16	
16(20)	10	4x5.4	0.16		28	3.3	4x5.4	0.12	16
	22	4x5.4	0.16		29	4.7	5x5.4	0.12	23
	33	5x5.4	0.16		39	6.8	5x5.4	0.12	30
		5x5.4	0.16		40	10	5x5.4	0.12	35
	47	5x5.4	0.16		42	22	6.3x5.4	0.12	40
		6.3x5.4	0.16		70	33	6.3x7.7	0.12	42
	100	6.3x5.4	0.16		71	47	6.3x7.7	0.12	65
		6.3x7.7	0.16		130	8x6.2	0.12	91	
		6.3x7.7	0.16		130	8x6.2	0.12	110	
	220	8x6.2	0.20		130	100	6.3x7.7	0.12	110
		8x10.2	0.20		150	150	8x6.2	0.12	110
		10x10.2	0.20		210	220	8x10.2	0.12	210
	330	10x10.2	0.20	260	330	8x10.2	0.12	240	
	470	8x10.2	0.20	240	470	10x10.2	0.12	320	
10x10.2		0.20	380	1000	10x10.2	0.12	300		
1000	12.5x13.5	0.34	550	220	10x10.2	0.12	330		
2200	16x16.5	0.34	900	330	12.5x13.5	0.16	490		
25(32)	3.3	4x5.4	0.14	18	470	12.5x16	0.18	550	
	4.7	4x5.4	0.14	22	1000	16x16.5	0.18	800	
	6.8	4x5.4	0.14	25	33	8x10.2	0.18	140	
		4x5.4	0.14	25	47	8x10.2	0.18	170	
	10	5x5.4	0.14	28	100	10x10.2	0.18	340	
		5x5.4	0.14	28	150	10x10.2	0.18	360	
	22	6.3x5.4	0.14	55	220	12.5x13.5	0.14	470	
		6.3x5.4	0.14	55	330	12.5x16	0.14	550	
33	6.3x5.4	0.14	65	470	16x16.5	0.14	650		
47	6.3x5.4	0.14	65	700	16x16.5	0.14	700		

Jamicon Series : CH

Teapo Series : DV

■ STANDARD RATINGS

Rated Voltage (SurageVoltage) (V)	Cap (μ F)	Case size Φ DxL(mm)	$\tan \delta$ (%)	Ripple current (mA/rms 105°C) (120Hz)
100(125)	10	6.3x7.7	0.18	50
	22	8x10.2	0.18	100
	33	8x10.2	0.18	120
		10x10.2	0.18	150
	47	10x10.2	0.18	170
		12.5x13.5	0.18	250
		12.5x13.5	0.18	300
160(200)	33	12.5x13.5	0.20	95
	47	16x16.5	0.20	240
	100	16x16.5	0.20	250
200(250)	10	12.5x13.5	0.20	80
	22	12.5x16	0.20	110
	33	12.5x16	0.20	120
	47	16x16.5	0.20	220

Rated Voltage (SurageVoltage) (V)	Cap (μ F)	Case size Φ DxL(mm)	$\tan \delta$ (%)	Ripple current (mA/rms 105°C) (120Hz)
250(300)	3.3	12.5x13.5	0.20	60
	4.7	12.5x13.5	0.20	65
	10	12.5x13.5	0.20	70
	22	12.5x13.5	0.20	105
	33	16x16.5	0.20	180
	47	16x16.5	0.20	220
	400 (450)	3.3	12.5x13.5	0.25
4.7		12.5x13.5	0.25	45
10		12.5x13.5	0.25	50
22		16x16.5	0.25	85
33		16x16.5	0.25	85
450 (500)	3.3	12.5x13.5	0.25	40
	4.7	12.5x13.5	0.25	45
	10	12.5x16	0.25	75
	22	16x16.5	0.25	85

Jamicon Series : CW

Teapo Series : FV Long life Series

- Endurance:85°C, 3000~5000 hours
- Recommended Applications: Suitable for AV(TV,Video,Audio),Monitor/Computer, Home appliance, OA/HA/Com
- Corresponding product to RoHS



Jamicon



Teapo

Specifications

Item	Characteristics																																								
Category Temperature Range	-55 ~ +85°C																																								
Rated Voltage Range	4 ~ 100VDC																																								
Rated Capacitance Range	1 ~ 1000 μF																																								
Capacitance Tolerance	± 20 % at 120Hz, 20°C																																								
Leakage Current (20°C)	$I \leq 0.01CV$ or $3 \mu A$, whichever is greater. (After rated voltage applied for 2 minutes) I : Max. leakage current (μA), C : Nominal capacitance (μF), V : Rated voltage (V)																																								
Dissipation Factor(MAX) (tan δ) (120Hz, 20°C)	Shown in the table of standard rating																																								
Low Temperature Stability Impedance Ratio (MAX)	<table border="1"> <thead> <tr> <th>WV</th> <th>4</th> <th>6.3</th> <th>10</th> <th>16</th> <th>25</th> <th>35</th> <th>50</th> <th>63</th> <th>100</th> </tr> </thead> <tbody> <tr> <td>Z(120HZ)</td> <td></td> <td></td> <td></td> <td></td> <td></td> <td></td> <td></td> <td></td> <td></td> </tr> <tr> <td>Z(-25°C) / Z(20°C)</td> <td>7</td> <td>4</td> <td>3</td> <td>2</td> <td>2</td> <td>2</td> <td>2</td> <td>2</td> <td>2</td> </tr> <tr> <td>Z(-40°C) / Z(20°C)</td> <td>15</td> <td>8</td> <td>6</td> <td>4</td> <td>4</td> <td>3</td> <td>3</td> <td>3</td> <td>3</td> </tr> </tbody> </table>	WV	4	6.3	10	16	25	35	50	63	100	Z(120HZ)										Z(-25°C) / Z(20°C)	7	4	3	2	2	2	2	2	2	Z(-40°C) / Z(20°C)	15	8	6	4	4	3	3	3	3
WV	4	6.3	10	16	25	35	50	63	100																																
Z(120HZ)																																									
Z(-25°C) / Z(20°C)	7	4	3	2	2	2	2	2	2																																
Z(-40°C) / Z(20°C)	15	8	6	4	4	3	3	3	3																																
Endurance	<p>After applying rated voltage for 3000~5000hours at 85°C, Stay back to 20 °C temperature measurement, the capacitors shall meet the following requirements.</p> <table border="1"> <tr> <td>Capacitance Change</td> <td>Within ±20% of the initial value</td> </tr> <tr> <td>Dissipation Factor</td> <td>Not more than 200% of the specified value</td> </tr> <tr> <td>Leakage Current</td> <td>Not more than the specified value</td> </tr> </table> <table border="1"> <tr> <td>DΦ</td> <td>4x5.4~6.3x7.7</td> <td>8x10.2~10x10.2</td> </tr> <tr> <td>Life time (hours)</td> <td>3000</td> <td>5000</td> </tr> </table>	Capacitance Change	Within ±20% of the initial value	Dissipation Factor	Not more than 200% of the specified value	Leakage Current	Not more than the specified value	DΦ	4x5.4~6.3x7.7	8x10.2~10x10.2	Life time (hours)	3000	5000																												
Capacitance Change	Within ±20% of the initial value																																								
Dissipation Factor	Not more than 200% of the specified value																																								
Leakage Current	Not more than the specified value																																								
DΦ	4x5.4~6.3x7.7	8x10.2~10x10.2																																							
Life time (hours)	3000	5000																																							
Shelf Life	The following specifications shall be satisfied when the capacitors are restored to 20°C after exposing them for 1,000 hours at 85°C without voltage applied. Before the measurement, the capacitor shall be preconditioned by applying voltage according to item 4.1 of JIS C 5101-4.																																								

MARKING

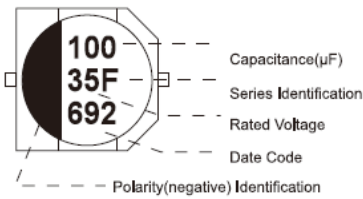

Teapo

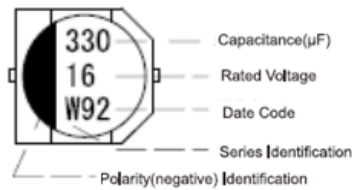

Jamicon

Dimensions [mm]

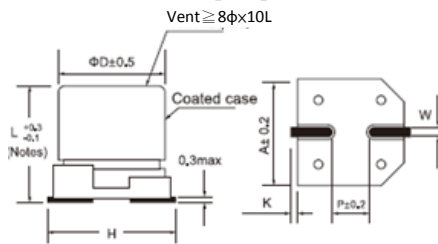

(Notes) Φ8 ~ Φ10&6.3X7.7=L±0.3

Dimensions	ΦD	L	A	H	W	P	K
B01	4.0	5.4	4.3	5.5 Max	0.65±0.1	1.0	0.35+0.15/-0.2
C01	5.0	5.4	5.3	6.5 Max	0.65±0.1	1.5	0.35+0.15/-0.2
E01	6.3	5.4	6.6	7.8 Max	0.65±0.1	2.1	0.35+0.15/-0.2
E04	6.3	7.7	6.6	7.8 Max	0.65±0.1	2.1	0.35+0.15/-0.2
G03	8.0	10.2	8.3	10.0 Max	0.90±0.2	3.1	0.70±0.20
H03	10.0	10.2	10.3	12.0 Max	0.90±0.2	4.6	0.70±0.20

Multiplier for Ripple Current

Frequency (Hz)	60	120	1K	10K
Coefficient	0.80	1.00	1.15	1.25

Jamicon Series : CW

Teapo Series : FV

■ STANDARD RATINGS

Rated Voltage (SurageVoltage) (V)	Cap (μ F)	Case size Φ DxL(mm)	$\tan \delta$	Ripple current (mA/rms 85°C) (120Hz)	Rated Voltage (SurageVoltage) (V)	Cap (μ F)	Case size Φ DxL(mm)	$\tan \delta$	Ripple current (mA/rms 85°C) (120Hz)
4(5)	22	4x5.4	0.35	19	25(32)	22	6.3x5.4	0.14	55
	33	4x5.4	0.35	26		33	6.3x5.4	0.14	65
	47	4x5.4	0.35	34		47	6.3x5.4	0.14	70
	100	5X5.4	0.35	61			6.3x7.7	0.14	96
	220	6.3X5.4	0.35	82		100	8x10.2	0.14	180
6.3(8)	22	4x5.4	0.26	20		220	10x10.2	0.14	310
	33	5x5.4	0.26	22	35(44)	2.2	4x5.4	0.12	8
	47	5x5.4	0.26	46		3.3	4x5.4	0.12	10
	100	6.3x5.4	0.26	71		4.7	4x5.4	0.12	22
	220	6.3x7.7	0.26	250		10	4x5.4	0.12	24
	330	6.3x7.7	0.26	300			5x5.4	0.12	30
	470	8x10.2	0.26	380		22	6.3x5.4	0.12	60
	1000	10x10.2	0.26	700		33	6.3x7.7	0.12	130
10(13)	22	4x5.4	0.20	28		47	6.3x7.7	0.12	165
	33	4x5.4	0.20	29		100	10x10.2	0.12	210
		5x5.4	0.20	43		220	10x10.2	0.12	310
	47	5x5.4	0.20	43	50(63)	1	4x5.4	0.12	10
	100	6.3x5.4	0.20	70		2.2	4x5.4	0.12	16
	220	6.3x7.7	0.20	250		3.3	4x5.4	0.12	16
	330	8x10.2	0.20	330		4.7	5x5.4	0.12	23
	470	10x10.2	0.20	400		10	6.3x5.4	0.12	35
1000	10x10.2	0.20	580	22		6.3x7.7	0.12	110	
16(20)	4.7	4x5.4	0.16	20		33	8x10.2	0.12	120
	10	4x5.4	0.16	28		47	10X10.2	0.12	130
	22	4x5.4	0.16	27	100	10x10.2	0.12	190	
		5x5.4	0.16	39	63(79)	4.7	8X10.2	0.18	25
	33	5x5.4	0.16	45		10	8X10.2	0.18	25
		6.3x5.4	0.16	66		22	8x10.2	0.18	45
	47	6.3x5.4	0.16	70		33	10x10.2	0.18	45
	100	6.3x5.4	0.16	70	47	10x10.2	0.18	55	
	220	8X10.2	0.16	280	100(125)	3.3	8X10.2	0.18	30
	330	10X10.2	0.16	380		4.7	8X10.2	0.18	80
470	10X10.2	0.16	420	10		8X10.2	0.18	85	
25(32)	4.7	4x5.4	0.14	22		22	10X10.2	0.18	85
	10	4x5.4	0.14	24		33	10X10.2	0.18	90
		5x5.4	0.14	28					

Jamicon Series : CK

Teapo Series : PV Low Impedance Series

■ Endurance:105°C, 1000~2000 hours

■ Recommended Applications: Suitable for AV(TV,Video,Audio),Monitor/Computer, Battery charger,DC/DC converter,SN

■ Corresponding product to RoHS



Jamicon



Teapo

■ Specifications

Item	Characteristics																												
Category Temperature Range	-55 ~ +105°C																												
Rated Voltage Range	6.3~ 50VDC																												
Rated Capacitance Range	4.7 ~ 1500 μF																												
Capacitance Tolerance	± 20 % at 120Hz , 20°C																												
Leakage Current (20°C)	$I \leq 0.01CV$ or $3 \mu A$,whichever is greater. (After rated voltage applied for 2 minutes) I : Max. leakage current (μA), C : Nominal capacitance (μF), V : Rated voltage (V)																												
Dissipation Factor(MAX) (tan δ) (120Hz,20°C)	Shown in the table of standard rating																												
Low Temperature Stability Impedance Ratio (MAX)	<table border="1"> <thead> <tr> <th>WV</th> <th>6.3</th> <th>10</th> <th>16</th> <th>25</th> <th>35</th> <th>50</th> </tr> </thead> <tbody> <tr> <td>Z(120HZ)</td> <td></td> <td></td> <td></td> <td></td> <td></td> <td></td> </tr> <tr> <td>Z(-40°C) / Z(20°C)</td> <td>3</td> <td>2</td> <td>2</td> <td>2</td> <td>2</td> <td>2</td> </tr> <tr> <td>Z(-55°C) / Z(20°C)</td> <td>5</td> <td>4</td> <td>4</td> <td>3</td> <td>3</td> <td>3</td> </tr> </tbody> </table>	WV	6.3	10	16	25	35	50	Z(120HZ)							Z(-40°C) / Z(20°C)	3	2	2	2	2	2	Z(-55°C) / Z(20°C)	5	4	4	3	3	3
WV	6.3	10	16	25	35	50																							
Z(120HZ)																													
Z(-40°C) / Z(20°C)	3	2	2	2	2	2																							
Z(-55°C) / Z(20°C)	5	4	4	3	3	3																							
Endurance	After applying rated voltage for 1000~2000hrs at 105°C,Stay back to 20 °C temperature measurement,the capacitors shall meet the following requirements.																												
	Capacitance Change	Within ±25% of the initial value																											
	Dissipation Factor	Not more than 200% of the specified value																											
	Leakage Current	Not more than the specified value																											
		<table border="1"> <tbody> <tr> <td>DΦ</td> <td>4x5.4~6.3x7.7</td> <td>8x10.2~10x10.2</td> </tr> <tr> <td>Life</td> <td>1000hrs</td> <td>2000hrs</td> </tr> </tbody> </table>	DΦ	4x5.4~6.3x7.7	8x10.2~10x10.2	Life	1000hrs	2000hrs																					
DΦ	4x5.4~6.3x7.7	8x10.2~10x10.2																											
Life	1000hrs	2000hrs																											
Shelf Life	The following specifications shall be satisfied when the capacitors are restored to 20°C after exposing them for1,000 hours at 105°C without voltage applied. Before the measurement, the capacitor shall be preconditioned by applying voltage according to item 4.1 of JIS C 5101-4.																												

■ MARKING

■ Dimensions [mm]

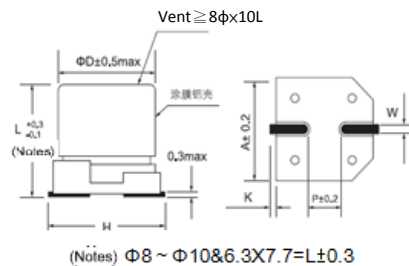
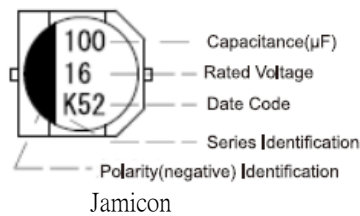
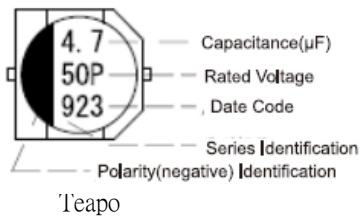

Dimensions	ΦD	L	A	H	W	P	K
B01	4.0	5.4	4.3	5.5 Max	0.65±0.1	1.0	0.35+0.15/-0.2
C01	5.0	5.4	5.3	6.5 Max	0.65±0.1	1.5	0.35+0.15/-0.2
E01	6.3	5.4	6.6	7.8 Max	0.65±0.1	2.1	0.35+0.15/-0.2
E04	6.3	7.7	6.6	7.8 Max	0.65±0.1	2.1	0.35+0.15/-0.2
G03	8.0	10.2	8.3	10.0 Max	0.90±0.2	3.1	0.70±0.20
H03	10.0	10.2	10.3	12.0 Max	0.90±0.2	4.6	0.70±0.20

■ Multiplier for Ripple Current

Frequency (Hz)	120	1K	10K	100K
Coefficient	0.70	0.80	0.90	1.00

Jamicon Series : CK

Teapo Series : PV

■STANDARD RATINGS

Rated Voltage (Surage Voltage) (V)	Cap (μF)	Case size ΦDxL(mm)	tan δ	Ripple current (mA/rms (100KHz)	Impedance (Ω,20℃) (100KHz)	Rated Voltage (Surage Voltage) (V)	Cap (μF)	Case size ΦDxL(mm)	tan δ	Ripple current (mA/rms (100KHz)	Impedance (Ω,20℃) (100KHz)
6.3(8)	27	4x5.4	0.24	90	1.45	25(32)	10	4x5.4	0.14	90	1.45
	33	5x5.4	0.24	170	0.70		15	5x5.4	0.14	170	0.70
	47	5x5.4	0.24	170	0.70		22	5x5.4	0.14	170	0.70
	56	5x5.4	0.24	170	0.70		27	6.3x5.4	0.14	250	0.39
	68	6.3x5.4	0.24	250	0.39		33	6.3x5.4	0.14	250	0.44
	100	6.3x5.4	0.24	250	0.39		47	6.3x5.4	0.14	250	0.39
	150	6.3x5.4	0.24	250	0.39		56	6.3x5.4	0.14	250	0.39
	220	6.3x5.4	0.24	250	0.39		68	6.3x5.4	0.14	250	0.39
	330	6.3x7.7	0.24	300	0.30		100	6.3x7.7	0.14	300	0.30
	470	8x10.2	0.28	600	0.15		150	8x10.2	0.16	600	0.15
	680	8x10.2	0.28	600	0.15		220	8x10.2	0.16	600	0.15
	1000	8x10.2	0.28	600	0.15		330	8x10.2	0.16	600	0.15
	1500	10x10.2	0.28	850	0.08		470	10x10.2	0.16	850	0.08
10(13)	22	4x5.4	0.20	90	1.45	35(44)	4.7	4x5.4	0.12	90	1.45
	27	5x5.4	0.20	170	0.70		10	5x5.4	0.12	170	0.70
	33	5x5.4	0.20	170	0.70		15	5x5.4	0.12	170	0.70
	47	6.3x5.4	0.20	250	0.39		22	5x5.4	0.12	170	0.70
	56	6.3x5.4	0.20	250	0.39		27	6.3x5.4	0.12	250	0.39
	68	6.3x5.4	0.20	250	0.39		33	6.3x5.4	0.12	250	0.39
	100	6.3x5.4	0.20	250	0.39		47	6.3x5.4	0.12	250	0.39
	150	6.3x5.4	0.20	250	0.39		56	6.3x7.7	0.12	300	0.30
	220	6.3x7.7	0.20	300	0.30		68	6.3x7.7	0.12	300	0.30
	330	8x10.2	0.24	600	0.15		100	8x10.2	0.14	600	0.15
	470	8x10.2	0.24	600	0.15		150	8x10.2	0.14	600	0.15
	680	10x10.2	0.24	850	0.08		220	8x10.2	0.14	600	0.15
	1000	10x10.2	0.24	850	0.08		330	10x10.2	0.14	850	0.08
16(20)	15	4x5.4	0.16	90	1.45	50(63)	4.7	4x5.4	0.12	64	2.55
	22	5x5.4	0.16	170	0.70		10	6.3x5.4	0.12	215	0.52
	27	5x5.4	0.16	150	0.76		15	6.3x5.4	0.12	215	0.52
	33	6.3x5.4	0.16	250	0.44		22	6.3x5.4	0.12	215	0.52
	47	6.3x5.4	0.16	250	0.39		27	6.3x7.7	0.12	243	0.44
	56	6.3x5.4	0.16	250	0.39		33	6.3x7.7	0.12	243	0.44
	68	6.3x5.4	0.16	250	0.39		47	6.3x7.7	0.12	243	0.44
	100	6.3x5.4	0.16	250	0.39		56	8x10.2	0.14	400	0.22
	150	6.3x7.7	0.16	300	0.30		68	8x10.2	0.14	400	0.22
	220	6.3x7.7	0.16	300	0.30		100	8x10.2	0.14	400	0.22
	330	8x10.2	0.20	600	0.15		150	10x10.2	0.14	585	0.13
	470	8x10.2	0.20	600	0.15		220	10x10.2	0.14	585	0.13
	680	10x10.2	0.20	850	0.08						

Jamicon Series : CL

Teapo Series : YV Low Impedance Series

■ Endurance:105°C, 1000~2000 hours

■ Recommended Applications: Suitable for AV(TV,Video,Audio),Monitor/Computer, Battery charger,DC/DC converter,SM

■ Corresponding product to RoHS



Jamicon



Teapo

■ Specifications

Item	Characteristics																												
Category Temperature Range	-55 ~ +105°C																												
Rated Voltage Range	6.3~ 50VDC																												
Rated Capacitance Range	1 ~ 1500 μ F																												
Capacitance Tolerance	\pm 20 % at 120Hz , 20°C																												
Leakage Current (20°C)	$I \leq 0.01CV$ or $3 \mu A$,whichever is greater. (After rated voltage applied for 2 minutes) I : Max. leakage current (μA), C : Nominal capacitance (μF), V : Rated voltage (V)																												
Dissipation Factor(MAX) (tan δ) (120Hz ,20°C)	Shown in the table of standard rating																												
Low Temperature Stability Impedance Ratio (MAX)	<table border="1"> <thead> <tr> <th>WV</th> <th>6.3</th> <th>10</th> <th>16</th> <th>25</th> <th>35</th> <th>50</th> </tr> </thead> <tbody> <tr> <td>Z(120HZ)</td> <td></td> <td></td> <td></td> <td></td> <td></td> <td></td> </tr> <tr> <td>Z(-25°C) / Z(20°C)</td> <td>2</td> <td>2</td> <td>2</td> <td>2</td> <td>2</td> <td>2</td> </tr> <tr> <td>Z(-40°C) / Z(20°C)</td> <td>4</td> <td>4</td> <td>3</td> <td>3</td> <td>3</td> <td>3</td> </tr> </tbody> </table>	WV	6.3	10	16	25	35	50	Z(120HZ)							Z(-25°C) / Z(20°C)	2	2	2	2	2	2	Z(-40°C) / Z(20°C)	4	4	3	3	3	3
WV	6.3	10	16	25	35	50																							
Z(120HZ)																													
Z(-25°C) / Z(20°C)	2	2	2	2	2	2																							
Z(-40°C) / Z(20°C)	4	4	3	3	3	3																							
Endurance	After applying rated voltage for 1000~2000hrs at 105°C,Stay back to 20 °C temperature measurement,the capacitors shall meet the following requirements.																												
	Capacitance Change	6.3V Within \pm 30% of the initial value,10-50V Within \pm 20% of the initial value																											
	Dissipation Factor	Not more than 200% of the specified value																											
	Leakage Current	Not more than the specified value																											
	D Φ	4x5.4~6.3x7.7	8x10.2~10x10.2																										
	Life	1000hrs	2000hrs																										
Shelf Life	The following specifications shall be satisfied when the capacitors are restored to 20°C after exposing them for1,000 hours at 105°C without voltage applied. Before the measurement, the capacitor shall be preconditioned by applying voltage according to item 4.1 of JIS C 5101-4.																												

■ MARKING

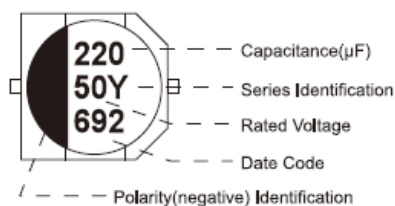

Teapo

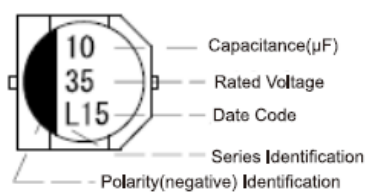

Jamicon

■ Dimensions [mm]

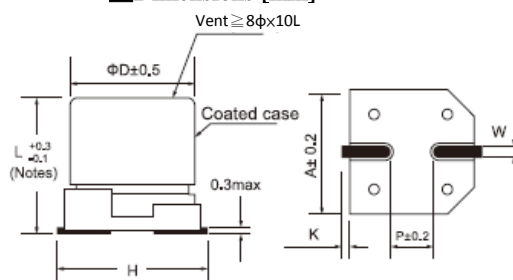

(Notes) $\Phi 8 \sim \Phi 10$ & $6.3 \times 7.7 = L \pm 0.3$

Dimensions	ΦD	L	A	H	W	P	K
B01	4.0	5.4	4.3	5.5 Max	0.65 \pm 0.1	1.0	0.35+0.15/-0.2
C01	5.0	5.4	5.3	6.5 Max	0.65 \pm 0.1	1.5	0.35+0.15/-0.2
E01	6.3	5.4	6.6	7.8 Max	0.65 \pm 0.1	2.1	0.35+0.15/-0.2
E04	6.3	7.7	6.6	7.8 Max	0.65 \pm 0.1	2.1	0.35+0.15/-0.2
G03	8.0	10.2	8.3	10.0 Max	0.90 \pm 0.2	3.1	0.70 \pm 0.20
H03	10.0	10.2	10.3	12.0 Max	0.90 \pm 0.2	4.6	0.70 \pm 0.20

■ Multiplier for Ripple Current

Frequency (Hz)	120	1K	10K	100K
Coefficient	0.70	0.80	0.90	1.00

Jamicon Series : CL

Teapo Series : YV

■ STANDARD RATINGS

Rated Voltage (SurageVoltage) (V)	Cap (μ F)	Case size Φ DxL(mm)	tan δ	Ripple current (mA/rms 105°C 100KHz)	Impedance (Ω,20°C) (100KHz)	Rated Voltage (SurageVoltage) (V)	Cap (μ F)	Case size Φ DxL(mm)	tan δ	Ripple current (mA/rms 105°C 100KHz)	Impedance (Ω,20°C) (100KHz)
6.3(8)	22	4x5.4	0.26	60	3.0	25(32)	22	6.3x5.4	0.14	140	1.0
	33	5x5.4	0.26	95	1.8		33	6.3x5.4	0.14	140	1.0
	47	5x5.4	0.26	95	1.8		47	6.3x5.4	0.14	140	1.0
	100	6.3x5.4	0.26	140	1.0		68	6.3x7.7	0.14	280	0.34
	220	6.3x5.4	0.26	140	1.0		100	6.3x7.7	0.14	280	0.34
	330	6.3x7.7	0.26	280	0.34		220	8x10.2	0.16	450	0.3
	470	8x10.2	0.35	450	0.3		330	8x10.2	0.16	450	0.3
	680	8x10.2	0.35	450	0.3		470	10x0.2	0.16	670	0.15
	1000	8x10.2	0.35	450	0.3		35(44)	4.7	4x5.4	0.12	60
1500	10x10.2	0.35	670	0.15	10	5x5.4		0.12	95	1.8	
10(13)	22	5x5.4	0.22	95	1.8	22		6.3x5.4	0.12	140	1.0
	33	5x5.4	0.22	95	1.8	33		6.3x5.4	0.12	140	1.0
	47	6.3x5.4	0.22	140	1.0	47		6.3x5.4	0.12	140	1.0
	100	6.3x5.4	0.22	140	1.0	68		6.3x7.7	0.12	280	0.34
	220	6.3x7.7	0.22	280	0.34	100		8x10.2	0.14	450	0.3
	330	8x10.2	0.26	450	0.3	220		8x10.2	0.14	450	0.3
	470	8x10.2	0.26	450	0.3	330		10x10.2	0.14	670	0.15
	680	10x10.2	0.26	670	0.15	50(63)	1	4x5.4	0.12	30	5.0
	1000	10x10.2	0.26	670	0.15		2.2	4x5.4	0.12	30	5.0
16(20)	10	4x5.4	0.16	60	3.0		3.3	4x5.4	0.12	30	5.0
	22	5x5.4	0.16	95	1.8		4.7	5x5.4	0.12	50	3.0
	33	6.3x5.4	0.16	140	1.0		10	6.3x5.4	0.12	70	2.0
	47	6.3x5.4	0.16	140	1.0		22	6.3x5.4	0.12	70	2.0
	100	6.3x5.4	0.16	140	1.0		33	6.3x7.7	0.12	170	1.3
	220	6.3x7.7	0.16	280	0.34		47	6.3x7.7	0.12	170	1.3
	330	8x10.2	0.20	450	0.3		68	8x10.2	0.12	300	0.6
	470	8x10.2	0.20	450	0.3		100	8x10.2	0.12	300	0.6
	680	10x10.2	0.20	670	0.15	220	10x10.2	0.12	500	0.3	
25(32)	10	5x5.4	0.14	95	1.8						

Jamicon Series : CE

Teapo Series : MV Low leakage current Series

- Endurance:105°C 2000 hours
- Recommended Applications:Low leakage current (0.5 μA to 2.0 μA max.)
- Corresponding product to RoHS



Jamicon



Teapo

■ Specifications

Item	Characteristics																								
Category Temperature Range	-40~ +105°C																								
Rated Voltage Range	6.3 ~ 50VDC																								
Rated Capacitance Range	1~ 100 μF																								
Capacitance Tolerance	± 20 % at 120Hz , 20°C																								
Leakage Current (20°C)	$I \leq 0.002CV$ or $0.5 \mu A$, whichever is greater. (After rated voltage applied for 2 minutes) I : Max. leakage current (μA), C : Nominal capacitance (μF), V : Rated voltage (V)																								
Dissipation Factor(MAX) (tan δ) (120Hz,20°C)	Shown in the table of standard rating																								
Low Temperature Stability Impedance Ratio (MAX)	<table border="1"> <thead> <tr> <th>WV</th> <th>6.3</th> <th>10</th> <th>25</th> <th>35</th> <th>50</th> </tr> </thead> <tbody> <tr> <td>Z(120HZ)</td> <td></td> <td></td> <td></td> <td></td> <td></td> </tr> <tr> <td>Z(-25°C) / Z(20°C)</td> <td>4</td> <td>3</td> <td>2</td> <td>2</td> <td>2</td> </tr> <tr> <td>Z(-40°C) / Z(20°C)</td> <td>8</td> <td>6</td> <td>4</td> <td>3</td> <td>3</td> </tr> </tbody> </table>	WV	6.3	10	25	35	50	Z(120HZ)						Z(-25°C) / Z(20°C)	4	3	2	2	2	Z(-40°C) / Z(20°C)	8	6	4	3	3
WV	6.3	10	25	35	50																				
Z(120HZ)																									
Z(-25°C) / Z(20°C)	4	3	2	2	2																				
Z(-40°C) / Z(20°C)	8	6	4	3	3																				
Endurance	After applying rated voltage for 2000Hrs at 105°C, Stay back to 20 °C temperature measurement, the capacitors shall meet the following requirements. <table border="1"> <tbody> <tr> <td>Capacitance Change</td> <td>Within ±25% of the initial value</td> </tr> <tr> <td>Dissipation Factor</td> <td>Not more than 200% of the specified value</td> </tr> <tr> <td>Leakage Current</td> <td>Not more than the specified value</td> </tr> </tbody> </table>	Capacitance Change	Within ±25% of the initial value	Dissipation Factor	Not more than 200% of the specified value	Leakage Current	Not more than the specified value																		
Capacitance Change	Within ±25% of the initial value																								
Dissipation Factor	Not more than 200% of the specified value																								
Leakage Current	Not more than the specified value																								
Shelf Life	The following specifications shall be satisfied when the capacitors are restored to 20°C after exposing them for 1,000 hours at 105°C without voltage applied. Before the measurement, the capacitor shall be preconditioned by applying voltage according to item 4.1 of JIS C 5101-4.																								

■ MARKING

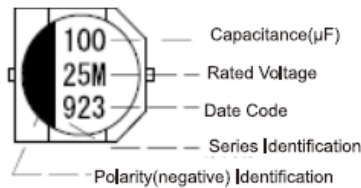

Teapo

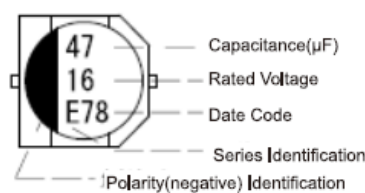

Jamicon

■ Dimensions [mm]

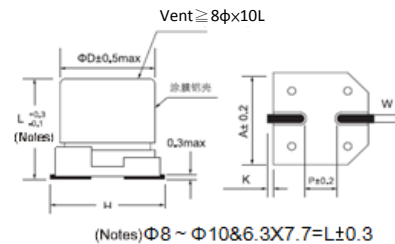

Dimensions	ΦD	L	A	H	W	P	K
B01	4.0	5.4	4.3	5.5 Max	0.65±0.1	1.0	0.35+0.15/-0.2
C01	5.0	5.4	5.3	6.5 Max	0.65±0.1	1.5	0.35+0.15/-0.2
E01	6.3	5.4	6.6	7.8 Max	0.65±0.1	2.1	0.35+0.15/-0.2

■ Multiplier for Ripple Current

Frequency (Hz)	60	120	1K	10K
Coefficient	0.85	1.00	1.10	1.20

Jamicon Series : CE

Teapo Series : MV

■ STANDARD RATINGS

Rated Voltage (SurageVoltage) (V)	Cap (μ F)	Case size Φ DxL(mm)	$\tan \delta$	Ripple current (mA/rms 105°C) (120Hz)	Rated Voltage (SurageVoltage) (V)	Cap (μ F)	Case size Φ DxL(mm)	$\tan \delta$	Ripple current (mA/rms 105°C) (120Hz)
6.3(8)	22	4x5.4	0.24	24	25(32)	4.7	4x5.4	0.14	14
	33	5x5.4	0.24	33		10	5x5.4	0.14	24
	47	5x5.4	0.24	39		22	6.3x5.4	0.14	41
	100	6.3x5.4	0.24	65		33	6.3x5.4	0.14	50
10(13)	22	5x5.4	0.20	30	35(44)	4.7	4x5.4	0.12	15
	33	5x5.4	0.20	36		10	5x5.4	0.12	26
	47	6.3x5.4	0.20	50		22	6.3x5.4	0.12	44
	100	6.3x5.4	0.20	70	50(63)	1.0	4x5.4	0.10	8
10	4x5.4	0.16	20	2.2		4x5.4	0.10	12	
22	5x5.4	0.16	33	3.3		4x5.4	0.10	14	
33	6.3x5.4	0.16	46	4.7		5x5.4	0.10	19	
16(20)	47	6.3x5.4	0.16	55	10	6.3x5.4	0.10	32	

Jamicon Series : CF

Teapo Series : EV

Low Impedance Series

■ Endurance: 105°C, 2000 hours

■ Recommended Applications: Applying to media (TV, video, audio), monitor /computer, Communication Power industry, car, electricity meter industry, car, electricity meter

■ Corresponding product to RoHS



Jamicon



Teapo

■ Specifications

Item	Characteristics																												
Category Temperature Range	-55 ~ +105°C																												
Rated Voltage Range	6.3~ 50VDC																												
Rated Capacitance Range	4.7 ~ 1500 μF																												
Capacitance Tolerance	± 20 % at 120Hz , 20°C																												
Leakage Current (20°C)	$I \leq 0.01CV$ or $3 \mu A$,whichever is greater. (After rated voltage applied for 2 minutes) I : Max. leakage current (μ A), C : Nominal capacitance (μ F), V : Rated voltage (V)																												
Dissipation Factor(MAX) (tan δ) (120Hz ,20°C)	Shown in the table of standard rating																												
Low Temperature Stability Impedance Ratio (MAX)	<table border="1"> <thead> <tr> <th>WV</th> <th>6.3</th> <th>10</th> <th>16</th> <th>25</th> <th>35</th> <th>50</th> </tr> </thead> <tbody> <tr> <td>Z(120HZ)</td> <td></td> <td></td> <td></td> <td></td> <td></td> <td></td> </tr> <tr> <td>Z(-25°C) / Z(20°C)</td> <td>2</td> <td>2</td> <td>2</td> <td>2</td> <td>2</td> <td>2</td> </tr> <tr> <td>Z(-40°C) / Z(20°C)</td> <td>3</td> <td>3</td> <td>3</td> <td>3</td> <td>3</td> <td>3</td> </tr> </tbody> </table>	WV	6.3	10	16	25	35	50	Z(120HZ)							Z(-25°C) / Z(20°C)	2	2	2	2	2	2	Z(-40°C) / Z(20°C)	3	3	3	3	3	3
WV	6.3	10	16	25	35	50																							
Z(120HZ)																													
Z(-25°C) / Z(20°C)	2	2	2	2	2	2																							
Z(-40°C) / Z(20°C)	3	3	3	3	3	3																							
Endurance	After applying rated voltage for 2000hrs at 105°C ,Stay back to 20 °C temperature measurement,the capacitors shall meet the following requirements. <table border="1"> <tbody> <tr> <td>Capacitance Change</td> <td>Within ±30% of the initial value</td> </tr> <tr> <td>Dissipation Factor</td> <td>Not more than 200% of the specified value</td> </tr> <tr> <td>Leakage Current</td> <td>Not more than the specified value</td> </tr> </tbody> </table>	Capacitance Change	Within ±30% of the initial value	Dissipation Factor	Not more than 200% of the specified value	Leakage Current	Not more than the specified value																						
Capacitance Change	Within ±30% of the initial value																												
Dissipation Factor	Not more than 200% of the specified value																												
Leakage Current	Not more than the specified value																												
Shelf Life	The following specifications shall be satisfied when the capacitors are restored to 20°C after exposing them for 1,000 hours at 105°C without voltage applied. Before the measurement, the capacitor shall be preconditioned by applying voltage according to item 4.1 of JIS C 5101-4.																												

■ MARKING

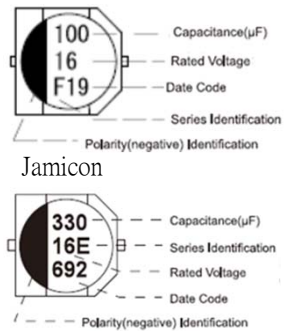

■ Dimensions [mm]

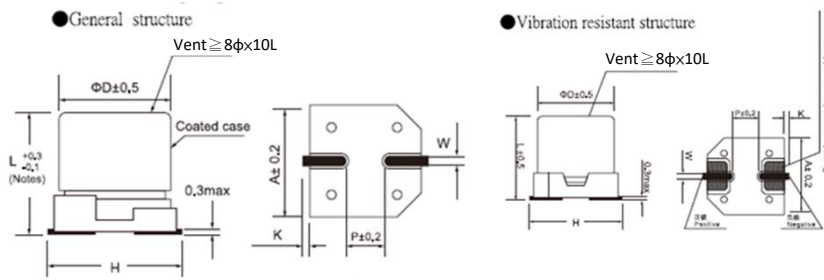

(注) Φ8 ~ Φ10&6.3X7.7=L±0.3

Dimensions	ΦD	L	A	H	W	P	K
B01	4.0	5.4	4.3	5.5 Max	0.65±0.1	1.0	0.35+0.15/-0.2
C01	5.0	5.4	5.3	6.5 Max	0.65±0.1	1.5	0.35+0.15/-0.2
E01	6.3	5.4	6.6	7.8 Max	0.65±0.1	2.1	0.35+0.15/-0.2
E04	6.3	7.7	6.6	7.8 Max	0.65±0.1	2.1	0.35+0.15/-0.2
G03	8.0	10.2	8.3	10.0 Max	0.90±0.2	3.1	0.70±0.20
G02	8.0	6.2	8.3	9.5 Max	0.65±0.1	2.2	0.35+0.15/-0.2
H03	10.0	10.2	10.3	12.0 Max	0.90±0.2	4.6	0.70±0.20

■ Multiplier for Ripple Current

Frequency (Hz)	120	1K	10K	100K
Coefficient	0.70	0.80	0.90	1.00

Jamicon Series : CF

Teapo Series : EV

■ STANDARD RATINGS

Rated Voltage (SurageVoltage) (V)	Cap (μF)	Case size ΦDxL(mm)	tan δ	Ripple current (mA/rms 105°C 100KHz)	Impedance (Ω,20°C) (100KHz)	Rated Voltage (SurageVoltage) (V)	Cap (μF)	Case size ΦDxL(mm)	tan δ	Ripple current (mA/rms 105°C 100KHz)	Impedance (Ω,20°C) (100KHz)	
6.3(8)	22	4x5.4	0.26	90	1.80	16 (20)	220	8x10.2	0.16	370	0.16	
	33	4x5.4	0.26	90	1.80		330	8x10.2	0.16	600	0.16	
	47	4x5.4	0.26	90	1.80		470	8x10.2	0.16	600	0.16	
		5x5.4	0.26	160	0.76			10x10.2	0.16	650	0.09	
	100	5x5.4	0.26	160	0.76		560	10x10.2	0.16	650	0.09	
		6.3x5.4	0.26	240	0.44	680		10x10.2	0.16	850	0.08	
	150	6.3x5.4	0.26	240	0.44		25 (32)	10	4x5.4	0.14	90	1.80
		220	6.3x7.7	0.26	240	0.34		22	5x5.4	0.14	95	1.80
	330		6.3x5.4	0.26	240	0.34			33	5x5.4	0.14	160
		470	8x6.2	0.26	240	0.34		47		6.3x5.4	0.14	240
	680		6.3x7.7	0.26	280	0.34			68	6.3x7.7	0.14	260
		1000	8x6.2	0.26	290	0.34		100		6.3x5.4	0.14	240
	1500		8x10.2	0.26	600	0.16			150	6.3x7.7	0.14	280
		680	8x10.2	0.26	600	0.16		220		8X6.2	0.14	280
	1000		8x10.2	0.26	600	0.16			330	8x10.2	0.14	600
1500		10x10.2	0.26	850	0.08	470		8x10.2		0.14	600	0.16
	10 (13)	22	4x5.4	0.19	90			1.80	35 (44)	4.7	4x5.4	0.12
33		4x5.4	0.19	90	1.80	10		4x5.4		0.12	90	1.80
		5x5.4	0.19	160	0.76		22	5x5.4		0.12	160	0.76
47		6.3x5.4	0.19	190	0.44	33		6.3x5.4		0.12	240	0.52
		100	6.3x5.4	0.19	190		0.44	47		6.3x5.4	0.12	240
150			6.3x5.4	0.19	200	0.44	68			6.3x7.7	0.12	280
		220	6.3x7.7	0.19	240	0.34		100		6.3x7.7	0.12	280
330			6.3x7.7	0.19	280	0.34	150			8x10.2	0.12	600
		470	8x6.2	0.19	280	0.34		220		8x10.2	0.12	600
680			8x10.2	0.19	600	0.16	330			10x10.2	0.12	850
		820	10x10.2	0.19	600	0.09		50 (63)		10	5X5.4	0.12
1000			10x10.2	0.19	850	0.08	22			6.3x5.4	0.12	165
		1200	10x10.2	0.19	850	0.08			33	6.3x5.4	0.12	165
3.3			4x5.4	0.16	60	1.80	47			6.3x7.7	0.12	185
		10	4x5.4	0.16	90	1.80			100	6.3x7.7	0.12	185
22	4x5.4		0.16	90	1.80	150	8X6.2			0.12	185	0.68
	33	5x5.4	0.16	160	0.76		220		8x10.2	0.12	300	0.34
47		5x5.4	0.16	160	1.00	330			10x10.2	0.12	670	0.18
	68	6.3x5.4	0.16	240	0.44		150		10x10.2	0.12	670	0.18
100		6.3x5.4	0.16	240	0.44	220			10x10.2	0.12	670	0.18
	150	6.3x7.7	0.16	280	0.34							
220		6.3x7.7	0.16	280	0.34							
		8x6.2	0.16	280	0.34							

Jamicon Series : CD

Teapo Series : LV Low Impedance,long life Series

■ Endurance:105°C, 2000~5000 hours

■ Recommended Applications: Suitable for AV(TV,Video,Audio),Monitor/Computer, Battery charger,DC/DC converter,SM

■ Corresponding product to RoHS



Jamicon



Teapo

■ Specifications

Item	Characteristics																											
Category Temperature Range	-55 ~ +105°C																											
Rated Voltage Range	6.3~ 50VDC																											
Rated Capacitance Range	4.7 ~ 1500 μF																											
Capacitance Tolerance	± 20 % at 120Hz , 20°C																											
Leakage Current (20°C)	$I \leq 0.01CV$ or $3 \mu A$, whichever is greater. (After rated voltage applied for 2 minutes) I : Max. leakage current (μA), C : Nominal capacitance (μF), V : Rated voltage (V)																											
Dissipation Factor(MAX) (tan δ) (120Hz, 20°C)	Shown in the table of standard rating																											
Low Temperature Stability Impedance Ratio (MAX)	<table border="1"> <thead> <tr> <th rowspan="3">WV Z(120HZ)</th> <th colspan="6">V</th> </tr> <tr> <th>6.3</th> <th>10</th> <th>16</th> <th>25</th> <th>35</th> <th>50</th> </tr> </thead> <tbody> <tr> <td>Z(-25°C) / Z(20°C)</td> <td>3</td> <td>3</td> <td>2</td> <td>2</td> <td>2</td> <td>2</td> </tr> <tr> <td>Z(-55°C) / Z(20°C)</td> <td>7</td> <td>7</td> <td>5</td> <td>3</td> <td>3</td> <td>3</td> </tr> </tbody> </table>	WV Z(120HZ)	V						6.3	10	16	25	35	50	Z(-25°C) / Z(20°C)	3	3	2	2	2	2	Z(-55°C) / Z(20°C)	7	7	5	3	3	3
WV Z(120HZ)	V																											
	6.3		10	16	25	35	50																					
	Z(-25°C) / Z(20°C)	3	3	2	2	2	2																					
Z(-55°C) / Z(20°C)	7	7	5	3	3	3																						
Endurance	<p>After applying rated voltage for 2000~5000hrs at 105°C, Stay back to 20 °C temperature measurement, the capacitors shall meet the following requirements.</p> <table border="1"> <tr> <td>Capacitance Change</td> <td>Within ±30% of the initial value</td> </tr> <tr> <td>Dissipation Factor</td> <td>Not more than 300% of the specified value</td> </tr> <tr> <td>Leakage Current</td> <td>Not more than the specified value</td> </tr> <tr> <td>DΦ</td> <td>5x5.4~6.3x7.7</td> <td>8x10.2~10x10.2</td> </tr> <tr> <td>Life</td> <td>2000hrs</td> <td>5000hrs</td> </tr> </table>	Capacitance Change	Within ±30% of the initial value	Dissipation Factor	Not more than 300% of the specified value	Leakage Current	Not more than the specified value	DΦ	5x5.4~6.3x7.7	8x10.2~10x10.2	Life	2000hrs	5000hrs															
Capacitance Change	Within ±30% of the initial value																											
Dissipation Factor	Not more than 300% of the specified value																											
Leakage Current	Not more than the specified value																											
DΦ	5x5.4~6.3x7.7	8x10.2~10x10.2																										
Life	2000hrs	5000hrs																										
Shelf Life	The following specifications shall be satisfied when the capacitors are restored to 20°C after exposing them for 1,000 hours at 105°C without voltage applied. Before the measurement, the capacitor shall be preconditioned by applying voltage according to item 4.1 of JIS C 5101-4.																											

■ MARKING

■ Dimensions [mm]

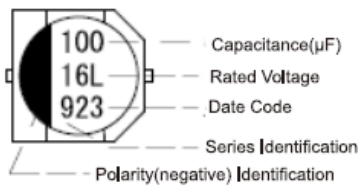

Teapo

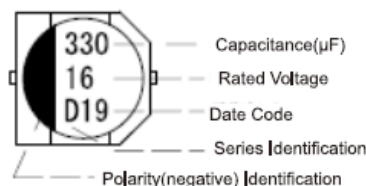

Jamicon

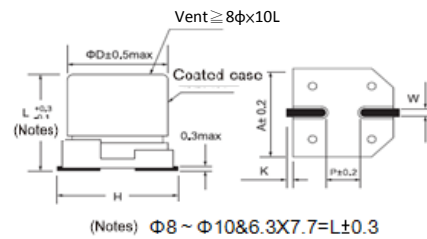

Dimensions	ΦD	L	A	H	W	P	K
B01	4.0	5.4	4.3	5.5 Max	0.65±0.1	1.0	0.35+0.15/-0.2
C01	5.0	5.4	5.3	6.5 Max	0.65±0.1	1.5	0.35+0.15/-0.2
E01	6.3	5.4	6.6	7.8 Max	0.65±0.1	2.1	0.35+0.15/-0.2
E04	6.3	7.7	6.6	7.8 Max	0.65±0.1	2.1	0.35+0.15/-0.2
G03	8.0	10.2	8.3	10.0 Max	0.90±0.2	3.1	0.70±0.20
H03	10.0	10.2	10.3	12.0 Max	0.90±0.2	4.6	0.70±0.20

■ Multiplier for Ripple Current

Frequency (Hz)	120	1K	10K	100K
Coefficient	0.70	0.80	0.90	1.00

Jamicon Series : CD

Teapo Series : LV

■ STANDARD RATINGS

Rated Voltage (SurageVoltage) (V)	Cap (μF)	Case size ΦDxL(mm)	tan δ	Ripple current (mA/rms (100KHz)	Impedance (Ω,20℃) (100KHz)	Rated Voltage (SurageVoltage) (V)	Cap (μF)	Case size ΦDxL(mm)	tan δ	Ripple current (mA/rms (100KHz)	Impedance (Ω,20℃) (100KHz)
6.3(8)	33	5x5.4	0.28	150	0.76	25(32)	22	5x5.4	0.16	150	1.00
	47	5x5.4	0.28	150	0.76		33	6.3x5.4	0.16	230	0.44
	100	6.3x5.4	0.28	230	0.44		47	6.3x5.4	0.16	230	0.44
	150	6.3x5.4	0.28	230	0.44		100	6.3x7.7	0.16	280	0.34
	220	6.3x5.4	0.28	230	0.44		150	8x10.2	0.16	450	0.17
	330	6.3x7.7	0.28	280	0.34		220	8x10.2	0.16	450	0.17
	470	8x10.2	0.28	450	0.17		330	8x10.2	0.16	450	0.17
	1000	8x10.2	0.28	450	0.17		470	10x10.2	0.16	670	0.09
10(13)	33	5x5.4	0.24	150	0.76	35(44)	10	5x5.4	0.13	150	0.76
	47	6.3x5.4	0.24	230	0.44		22	5x5.4	0.13	150	0.76
	100	6.3x5.4	0.24	230	0.44		33	6.3x5.4	0.13	230	0.44
	150	6.3x5.4	0.24	230	0.44		47	6.3x5.4	0.13	230	0.44
	220	6.3x7.7	0.24	280	0.34		100	8x10.2	0.13	450	0.17
	330	8x10.2	0.24	450	0.17		150	8x10.2	0.13	450	0.17
	470	8x10.2	0.24	450	0.17		220	8x10.2	0.13	450	0.17
	1000	10x10.2	0.24	670	0.09		330	10x10.2	0.13	670	0.09
16(20)	22	5x5.4	0.20	150	1.00	50(63)	4.7	5x5.4	0.12	85	1.52
	33	6.3x5.4	0.20	230	0.44		10	6.3x5.4	0.12	165	0.88
	47	6.3x5.4	0.20	230	0.44		22	6.3x5.4	0.12	165	0.88
	100	6.3x5.4	0.20	230	0.44		33	6.3x7.7	0.12	185	0.68
	150	6.3x7.7	0.20	280	0.34		47	6.3x7.7	0.12	185	0.68
	220	6.3x7.7	0.20	280	0.34		100	8x10.2	0.12	300	0.34
	330	8x10.2	0.20	450	0.17		150	10x10.2	0.12	670	0.18
	470	8x10.2	0.20	450	0.17		220	10x10.2	0.12	670	0.18

Jamicon Series : CU

Teapo Series : WV Long Life Series

■ Endurance:105°C, 3000~5000 hours

■ Recommended Applications: Suitable for AV(TV,Video,Audio),Monitor/Computer, Home appliance, OA/HA/Communication,Industrial, Automobile, Meter.

■ Corresponding product to RoHS



Jamicon



Teapo

■ Specifications

Item	Characteristics																					
Category Temperature Range	-55 ~ +105°C																					
Rated Voltage Range	6.3~ 50VDC																					
Rated Capacitance Range	1 ~ 1000 μ F																					
Capacitance Tolerance	\pm 20 % at 120Hz , 20°C																					
Leakage Current (20°C)	$I \leq 0.01CV$ or $3 \mu A$,whichever is greater. (After rated voltage applied for 2 minutes) I : Max. leakage current (μA), C : Nominal capacitance (μF), V : Rated voltage (V)																					
Dissipation Factor(MAX) (tan δ) (120Hz ,20°C)	Shown in the table of standard rating																					
Low Temperature Stability Impedance Ratio (MAX)	<table border="1"> <thead> <tr> <th rowspan="3">WV Z(120HZ)</th> <th colspan="6">6.3 10 16 25 35 50</th> </tr> </thead> <tbody> <tr> <td>Z(-25°C) / Z(20°C)</td> <td>4</td> <td>3</td> <td>2</td> <td>2</td> <td>2</td> <td>2</td> </tr> <tr> <td>Z(-55°C) / Z(20°C)</td> <td>10</td> <td>7</td> <td>5</td> <td>3</td> <td>3</td> <td>3</td> </tr> </tbody> </table>	WV Z(120HZ)	6.3 10 16 25 35 50						Z(-25°C) / Z(20°C)	4	3	2	2	2	2	Z(-55°C) / Z(20°C)	10	7	5	3	3	3
WV Z(120HZ)	6.3 10 16 25 35 50																					
	Z(-25°C) / Z(20°C)		4	3	2	2	2	2														
	Z(-55°C) / Z(20°C)	10	7	5	3	3	3															
Endurance	After applying rated voltage for 3000~5000hrs at 105°C,Stay back to 20 °C temperature measurement,the capacitors shall meet the following requirements. <table border="1"> <tbody> <tr> <td>Capacitance Change</td> <td colspan="2">Within \pm30% of the initial value</td> </tr> <tr> <td>Dissipation Factor</td> <td colspan="2">Not more than 200% of the specified value</td> </tr> <tr> <td>Leakage Current</td> <td colspan="2">Not more than the specified value</td> </tr> <tr> <td>DΦ</td> <td>4x5.4~6.3x7.7</td> <td>8x10.2~10x10.2</td> </tr> <tr> <td>Life</td> <td>3000hrs</td> <td>5000hrs</td> </tr> </tbody> </table>	Capacitance Change	Within \pm 30% of the initial value		Dissipation Factor	Not more than 200% of the specified value		Leakage Current	Not more than the specified value		D Φ	4x5.4~6.3x7.7	8x10.2~10x10.2	Life	3000hrs	5000hrs						
Capacitance Change	Within \pm 30% of the initial value																					
Dissipation Factor	Not more than 200% of the specified value																					
Leakage Current	Not more than the specified value																					
D Φ	4x5.4~6.3x7.7	8x10.2~10x10.2																				
Life	3000hrs	5000hrs																				
Shelf Life	The following specifications shall be satisfied when the capacitors are restored to 20°C after exposing them for1,000 hours at 105°C without voltage applied. Before the measurement, the capacitor shall be preconditioned by applying voltage according to item 4.1 of JIS C 5101-4.																					

■ MARKING

■ Dimensions [mm]

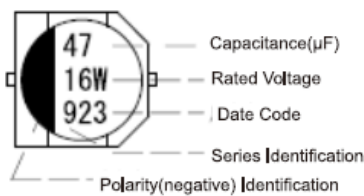

Teapo



Jamicon

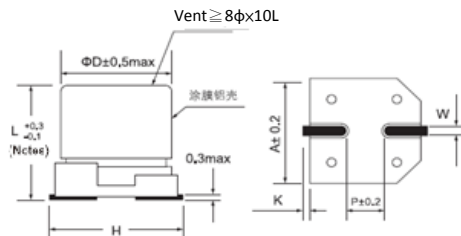

(Notes) $\Phi 8 \sim \Phi 10 \& 6.3 \times 7.7 = L \pm 0.3$

Dimensions	ΦD	L	A	H	W	P	K
B01	4.0	5.4	4.3	5.5 Max	0.65 \pm 0.1	1.0	0.35+0.15/-0.2
C01	5.0	5.4	5.3	6.5 Max	0.65 \pm 0.1	1.5	0.35+0.15/-0.2
E01	6.3	5.4	6.6	7.8 Max	0.65 \pm 0.1	2.1	0.35+0.15/-0.2
E04	6.3	7.7	6.6	7.8 Max	0.65 \pm 0.1	2.1	0.35+0.15/-0.2
G02	8.0	6.2	8.3	9.5 Max	0.65 \pm 0.1	2.2	0.35+0.15/-0.2
G03	8.0	10.2	8.3	10.0 Max	0.90 \pm 0.2	3.1	0.70 \pm 0.20
H03	10.0	10.2	10.3	12.0 Max	0.90 \pm 0.2	4.6	0.70 \pm 0.20

■ Multiplier for Ripple Current

Frequency (Hz)	60	120	1K	10K
Coefficient	0.85	1.00	1.15	1.25

Jamicon Series : CU

Teapo Series : WV

■ STANDARD RATINGS

Rated Voltage (SurageVoltage) (V)	Cap (μ F)	Case size Φ DxL(mm)	$\tan \delta$	Ripple current (mA/rms 105°C 120KHz)	Rated Voltage (SurageVoltage) (V)	Cap (μ F)	Case size Φ DxL(mm)	$\tan \delta$	Ripple current (mA/rms 105°C 120KHz)
6.3 (8)	22	4x5.4	0.28	23	25 (32)	10	5x5.4	0.16	23
	33	5x5.4	0.28	31		22	6.3x5.4	0.16	39
	47	5x5.4	0.28	38		33	6.3x5.4	0.16	48
	100	6.3x5.4	0.28	65		47	6.3x7.7	0.16	75
	220	6.3x7.7	0.28	120		100	8x10.2	0.16	140
	330	8x10.2	0.28	190		220	10x10.2	0.16	230
	470	10x10.2	0.28	260		330	10x10.2	0.16	290
10 (13)	1000	10x10.2	0.28	380	35 (44)	4.7	4x5.4	0.13	17
	22	5x5.4	0.24	28		10	5x5.4	0.13	25
	33	5x5.4	0.24	34		22	6.3x5.4	0.13	43
	47	6.3x5.4	0.24	47		33	6.3x7.7	0.13	70
	100	6.3x7.7	0.24	85		47	8x10.2	0.13	100
	220	8x10.2	0.24	170		100	10x10.2	0.13	170
	330	10x10.2	0.24	230		220	10x10.2	0.13	260
16 (20)	470	10x10.2	0.24	280	50 (63)	1.0	4x5.4	0.12	7
	10	4x5.4	0.20	18		2.2	4x5.4	0.12	11
	22	5x5.4	0.20	30		3.3	4x5.4	0.12	13
	33	6.3x5.4	0.20	43		4.7	5x5.4	0.12	18
	47	6.3x5.4	0.20	50		10	6.3x5.4	0.12	30
	100	6.3x7.7	0.20	95		22	6.3x7.7	0.12	60
	220	10x10.2	0.20	210		33	8x10.2	0.12	90
	330	10x10.2	0.20	260		47	8x10.2	0.12	120
470	10x10.2	0.20	330	100	10x10.2	0.12	180		

Jamicon Series : CZ

Teapo Series : XV Ultra Low Impedance & Long Life Series

- Endurance:105°C, 3000~5000 hours
- Recommended Applications: Suitable for AV(TV,Video,Audio),Monitor/Computer, Home appliance, OA/HA/Communication,Industrial, Automobile, Meter.
- Corresponding product to RoHS



Jamicon



Teapo

Specifications

Item	Characteristics																												
Category Temperature Range	-55 ~ +105°C																												
Rated Voltage Range	6.3~ 50VDC																												
Rated Capacitance Range	1 ~ 1000 μF																												
Capacitance Tolerance	± 20 % at 120Hz , 20°C																												
Leakage Current (20°C)	I ≤ 0.01CV or 3 μ A ,whichever is greater. (After rated voltage applied for 2 minutes) I : Max. leakage current (μ A), C : Nominal capacitance (μ F), V : Rated voltage (V)																												
Dissipation Factor(MAX) (tan δ) (120Hz ,20°C)	Shown in the table of standard rating																												
Low Temperature Stability Impedance Ratio (MAX)	<table border="1"> <thead> <tr> <th>WV</th> <th>6.3</th> <th>10</th> <th>16</th> <th>25</th> <th>35</th> <th>50</th> </tr> </thead> <tbody> <tr> <td>Z(120HZ)</td> <td></td> <td></td> <td></td> <td></td> <td></td> <td></td> </tr> <tr> <td>Z(-25°C) / Z(20°C)</td> <td>2</td> <td>2</td> <td>2</td> <td>2</td> <td>2</td> <td>2</td> </tr> <tr> <td>Z(-40°C) / Z(20°C)</td> <td>3</td> <td>3</td> <td>3</td> <td>3</td> <td>3</td> <td>3</td> </tr> </tbody> </table>	WV	6.3	10	16	25	35	50	Z(120HZ)							Z(-25°C) / Z(20°C)	2	2	2	2	2	2	Z(-40°C) / Z(20°C)	3	3	3	3	3	3
WV	6.3	10	16	25	35	50																							
Z(120HZ)																													
Z(-25°C) / Z(20°C)	2	2	2	2	2	2																							
Z(-40°C) / Z(20°C)	3	3	3	3	3	3																							
Endurance	<p>After applying rated voltage for 3000~5000hrs at 105°C,Stay back to 20 °C temperature measurement,the capacitors shall meet the following requirements.</p> <table border="1"> <tbody> <tr> <td>Capacitance Change</td> <td colspan="2">Within ±30% of the initial value</td> </tr> <tr> <td>Dissipation Factor</td> <td colspan="2">Not more than 200% of the specified value</td> </tr> <tr> <td>Leakage Current</td> <td colspan="2">Not more than the specified value</td> </tr> <tr> <td>DΦ</td> <td>4x5.4~6.3x7.7</td> <td>8x10.2~10x10.2</td> </tr> <tr> <td>Life</td> <td>3000hrs</td> <td>5000hrs</td> </tr> </tbody> </table>	Capacitance Change	Within ±30% of the initial value		Dissipation Factor	Not more than 200% of the specified value		Leakage Current	Not more than the specified value		DΦ	4x5.4~6.3x7.7	8x10.2~10x10.2	Life	3000hrs	5000hrs													
Capacitance Change	Within ±30% of the initial value																												
Dissipation Factor	Not more than 200% of the specified value																												
Leakage Current	Not more than the specified value																												
DΦ	4x5.4~6.3x7.7	8x10.2~10x10.2																											
Life	3000hrs	5000hrs																											
Shelf Life	The following specifications shall be satisfied when the capacitors are restored to 20°C after exposing them for 1,000 hours at 105°C without voltage applied. Before the measurement, the capacitor shall be preconditioned by applying voltage according to item 4.1 of JIS C 5101-4.																												

MARKING

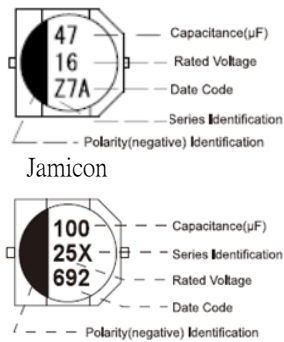

Dimensions [mm]

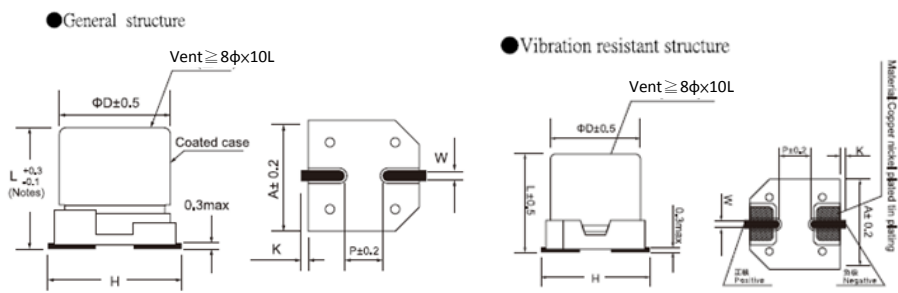

(Notes) Φ8 ~ Φ10&6.3X7.7=L±0.3

Dimensions	ΦD	L	A	H	W	P	K
B01	4.0	5.4	4.3	5.5 Max	0.65±0.1	1.0	0.35+0.15/-0.2
C01	5.0	5.4	5.3	6.5 Max	0.65±0.1	1.5	0.35+0.15/-0.2
E01	6.3	5.4	6.6	7.8 Max	0.65±0.1	2.1	0.35+0.15/-0.2
E04	6.3	7.7	6.6	7.8 Max	0.65±0.1	2.1	0.35+0.15/-0.2
G02	8.0	6.2	8.3	9.5 Max	0.65±0.1	2.2	0.35+0.15/-0.2
G03	8.0	10.2	8.3	10.0 Max	0.90±0.2	3.1	0.70±0.20
H03	10.0	10.2	10.3	12.0 Max	0.90±0.2	4.6	0.70±0.20

Multiplier for Ripple Current

Frequency (Hz)	120	1K	10K	100K
Coefficient	0.70	0.80	0.90	1.00

Jamicon Series : CZ

Teapo Series : XV

■ STANDARD RATINGS

Rated Voltage (SurageVoltage) (V)	Cap (μF)	Case size Φ DxL(mm)	tan δ	Ripple current (mA/rms 105°C 100KHz)	Impedance (Ω,20°C) (100KHz)	Rated Voltage (SurageVoltage) (V)	Cap (μF)	Case size Φ DxL(mm)	tan δ	Ripple current (mA/rms 105°C 100KHz)	Impedance (Ω,20°C) (100KHz)	
6.3 (8)	22	4x5.4	0.26	90	1.93	25(32)	33	6.3x5.4	0.14	240	0.52	
	33	4x5.4	0.26	90	1.93		47	6.3x5.4	0.14	240	0.52	
	47	5x5.4	0.26	160	1.00		68	6.3x7.7	0.14	280	0.34	
	100	6.3x5.4	0.26	240	0.52		100	6.3x7.7	0.14	300	0.34	
	150	6.3x7.7	0.26	240	0.30		150	8x10.2	0.14	600	0.16	
	220	6.3x5.4	0.26	240	0.52		220	8x10.2	0.14	600	0.16	
		6.3x7.7	0.26	240	0.30		330	10x10.2	0.14	850	0.12	
		8x10.2	0.26	600	0.26		470	10x10.2	0.14	850	0.12	
	330	8x10.2	0.26	600	0.16		35 (44)	4.7	4x5.4	0.12	90	1.93
	470	8x10.2	0.26	600	0.16			10	5x5.4	0.12	160	1.00
680	10x10.2	0.26	850	0.12	15	5x5.4		0.12	160	1.00		
1000	10x10.2	0.26	850	0.12	22	5x5.4		0.12	160	1.00		
10 (13)	22	4x5.4	0.19	90	1.93	47		33	6.3x5.4	0.12	240	0.52
	33	5x5.4	0.19	160	1.00			6.3x5.4	6.3x5.4	0.12	240	0.52
	47	6.3x5.4	0.19	190	0.52				6.3x7.7	0.12	280	0.34
	100	6.3x5.4	0.19	190	0.52	8x6.2			0.12	300	0.34	
		6.3x7.7	0.19	190	0.52	8x10.2		0.12	280	0.34		
	150	6.3x5.4	0.19	190	0.52	68		6.3x7.7	0.12	280	0.34	
		6.3x7.7	0.19	240	0.34			6.3x7.7	0.12	230	0.40	
		6.3x7.7	0.19	240	0.34	100		8x10.2	0.12	600	0.16	
	220	8x6.2	0.19	240	0.34			10x10.2	0.12	670	0.16	
		8x10.2	0.19	600	0.16	150		8x10.2	0.12	600	0.16	
330		8x10.2	0.19	600	0.16			10x10.2	0.12	850	0.12	
470	8x10.2	0.19	600	0.16	220	8x10.2		0.12	600	0.16		
	10x10.2	0.19	850	0.12		10x10.2	0.12	850	0.12			
	680	10x10.2	0.19	850	0.12	330	10x10.2	0.12	850	0.12		
1000	10x10.2	0.19	850	0.12	50 (63)		1.0	4x5.4	0.12	60	5.00	
16 (20)	10	4x5.4	0.16	90		1.93	2.2	4x5.4	0.12	60	5.00	
	22	5x5.4	0.16	160		1.00	3.3	4x5.4	0.12	60	5.00	
	33	6.3x5.4	0.16	240		0.52	4.7	5x5.4	0.12	95	4.00	
		6.3x5.4	0.16	240		0.52	10	6.3x5.4	0.12	140	2.00	
	47	5x5.4	0.16	160		1.00	22	6.3x5.4	0.12	70	2.00	
		6.3x5.4	0.16	240		0.52		6.3x7.7	0.12	230	1.30	
	100	6.3x5.4	0.16	240		0.52	33	8x10.2	0.12	350	0.34	
		6.3x7.7	0.16	280		0.34		47	6.3x7.7	0.12	230	1.30
		8x10.2	0.16	300		0.29	8x10.2		0.12	350	0.34	
	150	6.3x7.7	0.16	280		0.34	68	10x10.2	0.12	670	0.18	
		8x10.2	0.16	370		0.22		8x10.2	0.12	350	0.34	
	220	8x10.2	0.16	370		0.22	100	10x10.2	0.12	670	0.18	
	330	8x10.2	0.16	600		0.16		8x10.2	0.12	350	0.34	
	470	8x10.2	0.16	600		0.16	150	10x10.2	0.12	670	0.18	
		10x10.2	0.16	850		0.12		10x10.2	0.12	670	0.18	
		680	10x10.2	0.16	850	0.12	220	10x10.2	0.12	670	0.18	
25(32)	10	4x5.4	0.14	90	1.93							
	22	5x5.4	0.14	160	1.00							

Jamicon Series : CJ

Teapo Series : AV Low Impedance, long life Series

■ Endurance: 105°C, 5000 hours

■ Recommended Applications: Suitable for AV(TV, Video, Audio), Monitor/Computer, Battery charger, DC/DC converter, SMF

■ Corresponding product to RoHS



Jamicon



Teapo

■ Specifications

Item	Characteristics																											
Category Temperature Range	-55 ~ +105°C																											
Rated Voltage Range	6.3~ 50VDC																											
Rated Capacitance Range	10 ~ 470 μF																											
Capacitance Tolerance	± 20 % at 120Hz, 20°C																											
Leakage Current (20°C)	$I \leq 0.01CV$ or $3 \mu A$, whichever is greater. (After rated voltage applied for 2 minutes) I : Max. leakage current (μA), C : Nominal capacitance (μF), V : Rated voltage (V)																											
Dissipation Factor(MAX) (tan δ) (120Hz, 20°C)	Shown in the table of standard rating																											
Low Temperature Stability Impedance Ratio (MAX)	<table border="1"> <thead> <tr> <th rowspan="2">WV Z(120HZ)</th> <th colspan="6">WV</th> </tr> <tr> <th>6.3</th> <th>10</th> <th>16</th> <th>25</th> <th>35</th> <th>50</th> </tr> </thead> <tbody> <tr> <td>Z(-25°C) / Z(20°C)</td> <td>3</td> <td>3</td> <td>2</td> <td>2</td> <td>2</td> <td>2</td> </tr> <tr> <td>Z(-55°C) / Z(20°C)</td> <td>7</td> <td>7</td> <td>5</td> <td>3</td> <td>3</td> <td>3</td> </tr> </tbody> </table>	WV Z(120HZ)	WV						6.3	10	16	25	35	50	Z(-25°C) / Z(20°C)	3	3	2	2	2	2	Z(-55°C) / Z(20°C)	7	7	5	3	3	3
WV Z(120HZ)	WV																											
	6.3	10	16	25	35	50																						
Z(-25°C) / Z(20°C)	3	3	2	2	2	2																						
Z(-55°C) / Z(20°C)	7	7	5	3	3	3																						
Endurance	<p>After applying rated voltage for 5000hrs at 105°C, Stay back to 20 °C temperature measurement, the capacitors shall meet the following requirements.</p> <table border="1"> <tr> <td>Capacitance Change</td> <td>Within ±30% of the initial value</td> </tr> <tr> <td>Dissipation Factor</td> <td>Not more than 300% of the specified value</td> </tr> <tr> <td>Leakage Current</td> <td>Not more than the specified value</td> </tr> </table>	Capacitance Change	Within ±30% of the initial value	Dissipation Factor	Not more than 300% of the specified value	Leakage Current	Not more than the specified value																					
Capacitance Change	Within ±30% of the initial value																											
Dissipation Factor	Not more than 300% of the specified value																											
Leakage Current	Not more than the specified value																											
Shelf Life	The following specifications shall be satisfied when the capacitors are restored to 20°C after exposing them for 1,000 hours at 105°C without voltage applied. Before the measurement, the capacitor shall be preconditioned by applying voltage according to item 4.1 of JIS C 5101-4.																											

■ MARKING

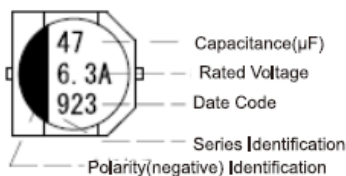

Teapo

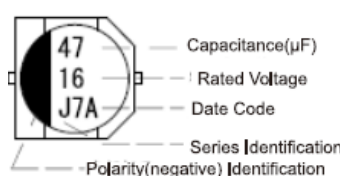

Jamicon

■ Dimensions [mm]

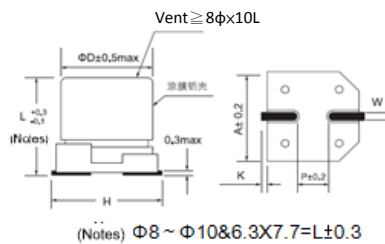

(Notes) Φ8 ~ Φ10 & 6.3X7.7=L±0.3

Dimensions	ΦD	L	A	H	W	P	K
B01	4.0	5.4	4.3	5.5 Max	0.65±0.1	1.0	0.35+0.15/-0.2
C01	5.0	5.4	5.3	6.5 Max	0.65±0.1	1.5	0.35+0.15/-0.2
E01	6.3	5.4	6.6	7.8 Max	0.65±0.1	2.1	0.35+0.15/-0.2
E08	6.3	5.8	6.6	7.8 Max	0.65±0.1	2.1	0.35+0.15/-0.2
E04	6.3	7.7	6.6	7.8 Max	0.65±0.1	2.1	0.35+0.15/-0.2
G03	8.0	10.2	8.3	10.0 Max	0.90±0.2	3.1	0.70±0.20
H03	10.0	10.2	10.3	12.0 Max	0.90±0.2	4.6	0.70±0.20

■ Multiplier for Ripple Current

Frequency (Hz)	120	1K	10K	100K
Coefficient	0.70	0.80	0.90	1.00

Jamicon Series : CJ

Teapo Series : AV

■ STANDARD RATINGS

Rated Voltage (SurageVoltage) (V)	Cap (μF)	Case size ΦDxL(mm)	tan δ	Ripple current (mA/rms (100KHz))	Impedance (Ω,20℃) (100KHz)	Rated Voltage (SurageVoltage) (V)	Cap (μF)	Case size ΦDxL(mm)	tan δ	Ripple current (mA/rms (100KHz))	Impedance (Ω,20℃) (100KHz)
6.3(8)	47	5x5.8	0.32	95	2.20	25(32)	22	5x5.8	0.16	95	2.20
	100	6.3x5.8	0.32	140	1.10		33	6.3x5.8	0.16	140	1.10
	220	6.3x5.8	0.32	230	1.00		47	6.3x5.8	0.16	140	1.10
	330	6.3x7.7	0.32	230	1.00		100	6.3x7.7	0.16	230	1.00
	470	8x10.2	0.32	600	0.22		220	8x10.2	0.16	600	0.22
10(13)	33	5x5.8	0.28	95	2.20		330	10x10.2	0.16	850	0.16
	47	6.3x5.8	0.28	140	1.10	35(44)	10	5x5.8	0.14	95	2.20
	100	6.3x5.8	0.28	140	1.10		22	6.3x5.8	0.14	140	1.10
	220	6.3x7.7	0.28	280	0.34		33	6.3x7.7	0.14	230	1.00
	330	8x10.2	0.28	450	0.22		47	6.3x7.7	0.14	230	1.00
16(20)	22	5x5.8	0.26	95	2.20		100	8x10.2	0.14	600	0.22
	33	6.3x5.8	0.26	140	1.10	220	10x10.2	0.14	850	0.16	
	47	6.3x5.8	0.26	140	1.10	50(63)	47	8x10.2	0.14	350	0.53
	100	6.3x7.7	0.26	140	1.10		100	8x10.2	0.14	560	0.32
	220	6.3x7.7	0.26	280	0.34		220	10x10.2	0.14	670	0.35
	330	8x10.2	0.26	450	0.22						

Jamicon Series : CA

Teapo Series : CV Low leakage current Series

- Endurance:85°C 2000 hours
- Recommended Applications:Low leakage current (0.5 μA to 2.0 μA max.)
- Corresponding product to RoHS



Jamicon



Teapo

■ Specifications

Item	Characteristics																							
Category Temperature Range	-40~ +85°C																							
Rated Voltage Range	6.3 ~ 50VDC																							
Rated Capacitance Range	1~ 100 μF																							
Capacitance Tolerance	± 20 % at 120Hz , 20°C																							
Leakage Current (20°C)	$I \leq 0.002CV$ or $0.5 \mu A$, whichever is greater. (After rated voltage applied for 2 minutes) I : Max. leakage current (μA), C : Nominal capacitance (μF), V : Rated voltage (V)																							
Dissipation Factor(MAX) (tan δ) (120Hz ,20°C)	Shown in the table of standard rating																							
Low Temperature Stability Impedance Ratio (MAX)	<table border="1"> <thead> <tr> <th rowspan="3">WV Z(120HZ)</th> <th colspan="5">WV</th> </tr> <tr> <th>6.3</th> <th>10</th> <th>25</th> <th>35</th> <th>50</th> </tr> </thead> <tbody> <tr> <td>Z(-25°C) / Z(20°C)</td> <td>4</td> <td>3</td> <td>2</td> <td>2</td> <td>2</td> </tr> <tr> <td>Z(-40°C) / Z(20°C)</td> <td>8</td> <td>6</td> <td>4</td> <td>3</td> <td>3</td> </tr> </tbody> </table>	WV Z(120HZ)	WV					6.3	10	25	35	50	Z(-25°C) / Z(20°C)	4	3	2	2	2	Z(-40°C) / Z(20°C)	8	6	4	3	3
WV Z(120HZ)	WV																							
	6.3		10	25	35	50																		
	Z(-25°C) / Z(20°C)	4	3	2	2	2																		
Z(-40°C) / Z(20°C)	8	6	4	3	3																			
Endurance	After applying rated voltage for 2000Hrs at 85°C, Stay back to 20 °C temperature measurement, the capacitors shall meet the following requirements. <table border="1"> <tr> <td>Capacitance Change</td> <td>Within ±25% of the initial value</td> </tr> <tr> <td>Dissipation Factor</td> <td>Not more than 200% of the specified value</td> </tr> <tr> <td>Leakage Current</td> <td>Not more than the specified value</td> </tr> </table>	Capacitance Change	Within ±25% of the initial value	Dissipation Factor	Not more than 200% of the specified value	Leakage Current	Not more than the specified value																	
Capacitance Change	Within ±25% of the initial value																							
Dissipation Factor	Not more than 200% of the specified value																							
Leakage Current	Not more than the specified value																							
Shelf Life	The following specifications shall be satisfied when the capacitors are restored to 20°C after exposing them for 1,000 hours at 85°C without voltage applied. Before the measurement, the capacitor shall be preconditioned by applying voltage according to item 4.1 of JIS C 5101-4.																							

■ MARKING

■ Dimensions [mm]

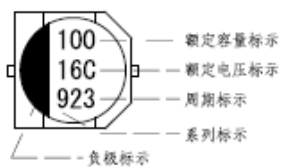

Teapo

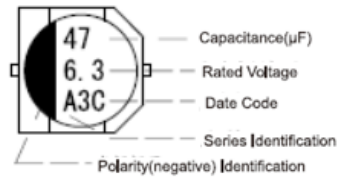

Jamicon

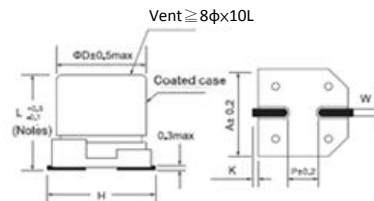

(Notes) Φ8 ~ Φ10&6.3X7.7=L±0.3

Dimensions	ΦD	L	A	H	W	P	K
B01	4.0	5.4	4.3	5.5 Max	0.65±0.1	1.0	0.35+0.15/-0.2
C01	5.0	5.4	5.3	6.5 Max	0.65±0.1	1.5	0.35+0.15/-0.2
E01	6.3	5.4	6.6	7.8 Max	0.65±0.1	2.1	0.35+0.15/-0.2

■ Multiplier for Ripple Current

Frequency (Hz)	60	120	1K	10K
Coefficient	0.85	1.00	1.10	1.20

Jamicon Series : CA

Teapo Series : CV

■ STANDARD RATINGS

Rated Voltage (SurageVoltage) (V)	Cap (μ F)	Case size Φ DxL(mm)	$\tan \delta$	Ripple current (mA/rms 105°C) (120Hz)	Rated Voltage (SurageVoltage) (V)	Cap (μ F)	Case size Φ DxL(mm)	$\tan \delta$	Ripple current (mA/rms 105°C) (120Hz)
6.3(8)	22	4x5.4	0.24	31	25(32)	4.7	4x5.4	0.14	19
	33	5x5.4	0.24	39		10	5x5.4	0.14	28
	47	5x5.4	0.24	47		22	6.3x5.4	0.14	52
	100	6.3x5.4	0.24	71		33	6.3x5.4	0.14	63
10(13)	22	5x5.4	0.20	35	35(44)	4.7	4x5.4	0.12	20
	33	5x5.4	0.20	43		22	5x5.4	0.12	30
	47	6.3x5.4	0.20	59		33	6.3x5.4	0.12	54
	100	6.3x5.4	0.20	76	50(63)	1.0	4x5.4	0.10	10
10	4x5.4	0.16	25	2.2		4x5.4	0.10	15	
22	5x5.4	0.16	39	3.3		4x5.4	0.10	18	
33	6.3x5.4	0.16	57	4.7		5x5.4	0.10	23	
16(20)	47	6.3x5.4	0.16	68	10	6.3x5.4	0.10	34	

Jamicon Series : CN

Teapo Series : RV

Non-polar Series



Jamicon



Teapo

- Endurance:85°C 2000 hours
- Recommended Applications:Non-polarized,Low profile vertical chip, 5.5mm height (≦ Φ6.3)
- Corresponding product to RoHS

■ Specifications

Item	Characteristics																							
Category Temperature Range	-40~ +85°C																							
Rated Voltage Range	6.3 ~ 50VDC																							
Rated Capacitance Range	1~ 47 μF																							
Capacitance Tolerance	± 20 % at 120Hz , 20°C																							
Leakage Current (20°C)	I ≤ 0.05CV or 10 μA , whichever is greater. (After rated voltage applied for 2 minutes) I : Max. leakage current (μA), C : Nominal capacitance (μF), V : Rated voltage (V)																							
Dissipation Factor(MAX) (tan δ) (120Hz, 20°C)	Shown in the table of standard rating																							
Low Temperature Stability Impedance Ratio (MAX)	<table border="1"> <thead> <tr> <th rowspan="2">WV Z(120HZ)</th> <th colspan="5">WV</th> </tr> <tr> <th>6.3</th> <th>10</th> <th>25</th> <th>35</th> <th>50</th> </tr> </thead> <tbody> <tr> <td>Z(-25°C) / Z(20°C)</td> <td>4</td> <td>3</td> <td>2</td> <td>2</td> <td>2</td> </tr> <tr> <td>Z(-40°C) / Z(20°C)</td> <td>8</td> <td>6</td> <td>4</td> <td>3</td> <td>3</td> </tr> </tbody> </table>	WV Z(120HZ)	WV					6.3	10	25	35	50	Z(-25°C) / Z(20°C)	4	3	2	2	2	Z(-40°C) / Z(20°C)	8	6	4	3	3
WV Z(120HZ)	WV																							
	6.3	10	25	35	50																			
Z(-25°C) / Z(20°C)	4	3	2	2	2																			
Z(-40°C) / Z(20°C)	8	6	4	3	3																			
Endurance	After applying rated voltage for 2000Hrs at 85°C, Stay back to 20 °C temperature measurement, the capacitors shall meet the following requirements. (The polarity need to exchange every 250 hours)																							
	<table border="1"> <tbody> <tr> <td>Capacitance Change</td> <td>Within ±25% of the initial value</td> </tr> <tr> <td>Dissipation Factor</td> <td>Not more than 200% of the specified value</td> </tr> <tr> <td>Leakage Current</td> <td>Not more than the specified value</td> </tr> </tbody> </table>	Capacitance Change	Within ±25% of the initial value	Dissipation Factor	Not more than 200% of the specified value	Leakage Current	Not more than the specified value																	
Capacitance Change	Within ±25% of the initial value																							
Dissipation Factor	Not more than 200% of the specified value																							
Leakage Current	Not more than the specified value																							
Shelf Life	The following specifications shall be satisfied when the capacitors are restored to 20°C after exposing them for 1,000 hours at 105°C without voltage applied. Before the measurement, the capacitor shall be preconditioned by applying voltage according to item 4.1 of JIS C 5101-4.																							

■ MARKING

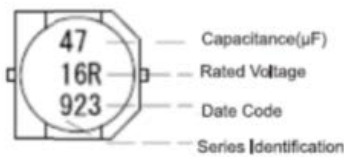

Teapo

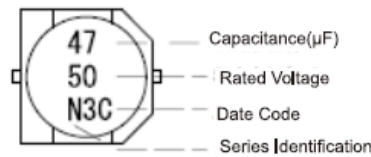

Jamicon

■ Dimensions [mm]

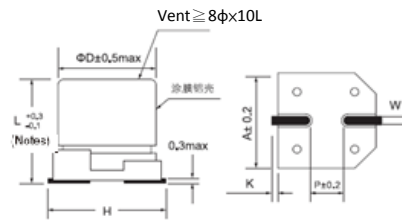

(Notes) Φ8 ~ Φ10 & 6.3X7.7=L±0.3

Dimensions	ΦD	L	A	H	W	P	K
B01	4.0	5.4	4.3	5.5 Max	0.65±0.1	1.0	0.35+0.15/-0.2
C01	5.0	5.4	5.3	6.5 Max	0.65±0.1	1.5	0.35+0.15/-0.2
E01	6.3	5.4	6.6	7.8 Max	0.65±0.1	2.1	0.35+0.15/-0.2

■ Multiplier for Ripple Current

Frequency (Hz)	60	120	1K	10K
Coefficient	0.85	1.00	1.10	1.20

Jamicon Series : CN

Teapo Series : RV

Non-polar Series

■ STANDARD RATINGS

Rated Voltage (SurageVoltage) (V)	Cap (μ F)	Case size Φ D \times L(mm)	tan δ	Ripple current (mA/rms 85°C) (120Hz)
6.3(8)	22	5x5.4	0.26	29
	33	6.3x5.4	0.26	41
	47	6.3x5.4	0.26	49
10(13)	10	4x5.4	0.22	19
	22	6.3x5.4	0.22	36
	33	6.3x5.4	0.22	45
16(20)	4.7	4x5.4	0.20	14
	10	5x5.4	0.20	23
	22	6.3x5.4	0.20	39
	33	6.3x5.4	0.20	48

Rated Voltage (SurageVoltage) (V)	Cap (μ F)	Case size Φ D \times L(mm)	tan δ	Ripple current (mA/rms 85°C) (120Hz)
25(32)	3.3	5x5.4	0.20	13
	4.7	5x5.4	0.20	16
	10	6.3x5.4	0.20	27
35(44)	2.2	4x5.4	0.20	10
	3.3	5x5.4	0.20	14
	4.7	5x5.4	0.20	17
	10	6.3x5.4	0.20	28
50(63)	1.0	4x5.4	0.18	7
	2.2	5x5.4	0.18	12
	3.3	5x5.4	0.18	14
	4.7	6.3x5.4	0.18	19

Jamicon Series : CP

Teapo Series : NV

Non-polar Series

- Endurance:105°C 2000 hours
- Recommended Applications:Non-polarized,Low profile vertical chip, 5.5mm height ($\leq \Phi 6.3$)
- Corresponding product to RoHS



Jamicon



Teapo

■ Specifications

Item	Characteristics																							
Category Temperature Range	-55 ~ +105°C																							
Rated Voltage Range	6.3 ~ 50VDC																							
Rated Capacitance Range	1 ~ 47 μ F																							
Capacitance Tolerance	$\pm 20\%$ at 120Hz, 20°C																							
Leakage Current (20°C)	$I \leq 0.05CV$ or $10 \mu A$, whichever is greater. (After rated voltage applied for 2 minutes) I : Max. leakage current (μA), C : Nominal capacitance (μF), V : Rated voltage (V)																							
Dissipation Factor(MAX) (tan δ) (120Hz, 20°C)	Shown in the table of standard rating																							
Low Temperature Stability Impedance Ratio (MAX)	<table border="1"> <thead> <tr> <th rowspan="3">WV Z(120HZ)</th> <th colspan="5">WV</th> </tr> <tr> <th>6.3</th> <th>10</th> <th>25</th> <th>35</th> <th>50</th> </tr> </thead> <tbody> <tr> <td>Z(-25°C) / Z(20°C)</td> <td>4</td> <td>3</td> <td>2</td> <td>2</td> <td>2</td> </tr> <tr> <td>Z(-40°C) / Z(20°C)</td> <td>8</td> <td>6</td> <td>4</td> <td>3</td> <td>3</td> </tr> </tbody> </table>	WV Z(120HZ)	WV					6.3	10	25	35	50	Z(-25°C) / Z(20°C)	4	3	2	2	2	Z(-40°C) / Z(20°C)	8	6	4	3	3
WV Z(120HZ)	WV																							
	6.3		10	25	35	50																		
	Z(-25°C) / Z(20°C)	4	3	2	2	2																		
Z(-40°C) / Z(20°C)	8	6	4	3	3																			
Endurance	After applying rated voltage for 2000Hrs at 105°C, Stay back to 20 °C temperature measurement, the capacitors shall meet the following requirements. (The polarity need to exchange every 250 hours)																							
	<table border="1"> <tbody> <tr> <td>Capacitance Change</td> <td>Within $\pm 20\%$ of the initial value</td> </tr> <tr> <td>Dissipation Factor</td> <td>Not more than 200% of the specified value</td> </tr> <tr> <td>Leakage Current</td> <td>Not more than the specified value</td> </tr> </tbody> </table>	Capacitance Change	Within $\pm 20\%$ of the initial value	Dissipation Factor	Not more than 200% of the specified value	Leakage Current	Not more than the specified value																	
Capacitance Change	Within $\pm 20\%$ of the initial value																							
Dissipation Factor	Not more than 200% of the specified value																							
Leakage Current	Not more than the specified value																							
Shelf Life	The following specifications shall be satisfied when the capacitors are restored to 20°C after exposing them for 1,000 hours at 105°C without voltage applied. Before the measurement, the capacitor shall be preconditioned by applying voltage according to item 4.1 of JIS C 5101-4.																							

■ MARKING

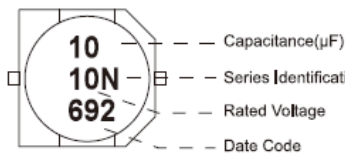

Teapo

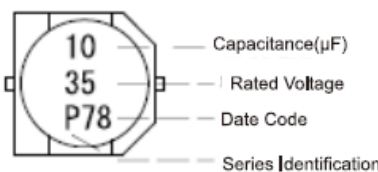

Jamicon

■ Dimensions [mm]

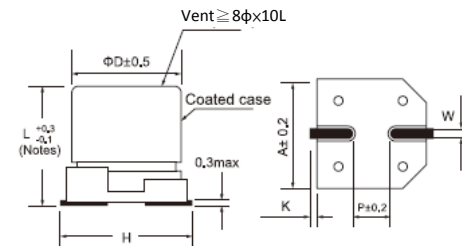

(Notes) $\Phi 8 \sim \Phi 10 \& 6.3 \times 7.7 = L \pm 0.3$

Dimensions	ΦD	L	A	H	W	P	K
B01	4.0	5.4	4.3	5.5 Max	0.65 ± 0.1	1.0	$0.35 + 0.15 / - 0.2$
C01	5.0	5.4	5.3	6.5 Max	0.65 ± 0.1	1.5	$0.35 + 0.15 / - 0.2$
E01	6.3	5.4	6.6	7.8 Max	0.65 ± 0.1	2.1	$0.35 + 0.15 / - 0.2$

■ Multiplier for Ripple Current

Frequency (Hz)	60	120	1K	10K
Coefficient	0.85	1.00	1.10	1.20

Jamicon Series : CP

Teapo Series : NV

Non-polar Series

■ STANDARD RATINGS

Rated Voltage (SurageVoltage) (V)	Cap (μF)	Case size Φ DxL(mm)	$\tan \delta$	Ripple current (mA/rms 105°C) (120Hz)	Rated Voltage (SurageVoltage) (V)	Cap (μF)	Case size Φ DxL(mm)	$\tan \delta$	Ripple current (mA/rms 105°C) (120Hz)
6.3(8)	22	5x5.4	0.26	29	25(32)	4.7	5x5.4	0.20	21
	33	6.3x5.4	0.26	43		10	6.3x5.4	0.20	28
	47	6.3x5.4	0.26	46	35(44)	2.2	4X5.4	0.20	12
10(13)	10	4X5.4	0.22	25		3.3	5x5.4	0.20	21
	22	6.3x5.4	0.22	39		4.7	5x5.4	0.20	22
	33	6.3x5.4	0.22	43		10	6.3x5.4	0.20	30
16(20)	4.7	4X5.4	0.20	20	50(63)	1.0	4X5.4	0.18	10
	10	5x5.4	0.20	25		2.2	5x5.4	0.18	16
	22	6.3x5.4	0.20	39		3.3	5x5.4	0.18	21
25(32)	3.3	4X5.4	0.20	12		4.7	6.3x5.4	0.18	31

Jamicon Series : CB

Teapo Series : HV 125°C High temperature Series

- Endurance:125°C, 1000~2000 hours
- Recommended Applications: Automatic Mounting and Reflow Soldering,Industrial, Automobile, Meter
- Corresponding product to RoHS



Jamicon



Teapo

■ Specifications

Item	Characteristics																								
Category Temperature Range	-40 ~ +125°C																								
Rated Voltage Range	10 ~ 50VDC																								
Rated Capacitance Range	47~ 1000 μ F																								
Capacitance Tolerance	\pm 20 % at 120Hz , 20°C																								
Leakage Current (20°C)	$I \leq 0.01CV$ or $3 \mu A$, whichever is greater. (After rated voltage applied for 2 minutes) I : Max. leakage current (μA), C : Nominal capacitance (μF), V : Rated voltage (V)																								
Dissipation Factor(MAX) (tan δ) (120Hz ,20°C)	Shown in the table of standard rating																								
Low Temperature Stability Impedance Ratio (MAX)	<table border="1"> <thead> <tr> <th>WV</th> <th>10</th> <th>16</th> <th>25</th> <th>35</th> <th>50</th> </tr> </thead> <tbody> <tr> <td>Z(120HZ)</td> <td></td> <td></td> <td></td> <td></td> <td></td> </tr> <tr> <td>Z(-25°C) / Z(20°C)</td> <td>2</td> <td>2</td> <td>2</td> <td>2</td> <td>2</td> </tr> <tr> <td>Z(-40°C) / Z(20°C)</td> <td>3</td> <td>3</td> <td>3</td> <td>3</td> <td>3</td> </tr> </tbody> </table>	WV	10	16	25	35	50	Z(120HZ)						Z(-25°C) / Z(20°C)	2	2	2	2	2	Z(-40°C) / Z(20°C)	3	3	3	3	3
WV	10	16	25	35	50																				
Z(120HZ)																									
Z(-25°C) / Z(20°C)	2	2	2	2	2																				
Z(-40°C) / Z(20°C)	3	3	3	3	3																				
Endurance	After applying rated voltage for 1000~2000hrs at 125°C,Stay back to 20 °C temperature measurement,the capacitors shall meet the following requirements. <table border="1"> <tbody> <tr> <td>Capacitance Change</td> <td colspan="2">Within \pm30% of the initial value</td> </tr> <tr> <td>Dissipation Factor</td> <td colspan="2">Not more than 300% of the specified value</td> </tr> <tr> <td>DΦ</td> <td>6.3x7.7-8x6.2</td> <td>$\geq 8 \times 10.2$</td> </tr> <tr> <td>Life</td> <td>1000hrs</td> <td>2000hrs</td> </tr> <tr> <td>Leakage Current</td> <td colspan="2">Not more than the specified value</td> </tr> </tbody> </table>	Capacitance Change	Within \pm 30% of the initial value		Dissipation Factor	Not more than 300% of the specified value		D Φ	6.3x7.7-8x6.2	$\geq 8 \times 10.2$	Life	1000hrs	2000hrs	Leakage Current	Not more than the specified value										
Capacitance Change	Within \pm 30% of the initial value																								
Dissipation Factor	Not more than 300% of the specified value																								
D Φ	6.3x7.7-8x6.2	$\geq 8 \times 10.2$																							
Life	1000hrs	2000hrs																							
Leakage Current	Not more than the specified value																								
Shelf Life	The following specifications shall be satisfied when the capacitors are restored to 20°C after exposing them for 1,000 hours at 125°C without voltage applied. Before the measurement, the capacitor shall be preconditioned by applying voltage according to item 4.1 of JIS C 5101-4.																								

■ MARKING

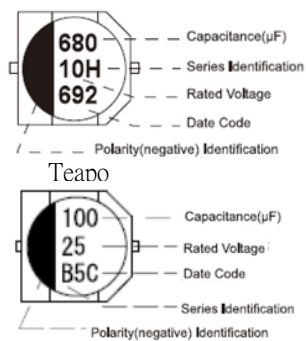

Jamicon

■ Dimensions [mm]

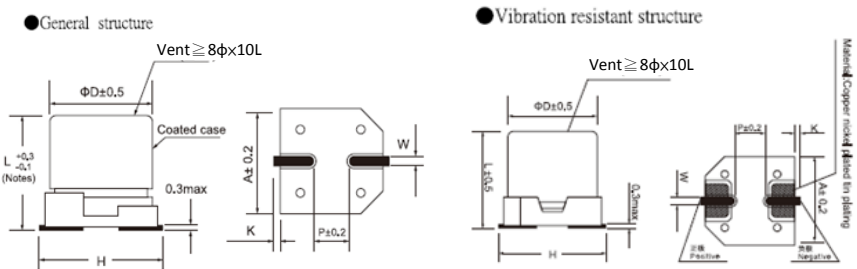

(Notes) $\Phi 8 \sim \Phi 10 \& 3 \times 7 = +0.3$

Dimensions	ΦD	L	A	H	W	P	K
E04	6.3	7.7	6.6	7.8 Max	0.65 \pm 0.1	2.1	0.35+0.15/-0.2
G02	8.0	6.2	8.3	9.5 Max	0.65 \pm 0.1	2.2	0.35+0.15/-0.2
G03	8.0	10.2	8.3	10.0 Max	0.90 \pm 0.2	3.1	0.70 \pm 0.20
H03	10.0	10.2	10.3	12.0 Max	0.90 \pm 0.2	4.6	0.70 \pm 0.20

■ Multiplier for Ripple Current

Frequency (Hz)	60	120	1K	10K
Coefficient	0.85	1.00	1.20	1.30

Jamicon Series : CB

Teapo Series : HV

■ STANDARD RATINGS

Rated Voltage (SurageVoltage) (V)	Cap (μ F)	Case size Φ DxL(mm)	$\tan \delta$ (%)	Ripple current (mA/rms 125°C) (120Hz)	Rated Voltage (SurageVoltage) (V)	Cap (μ F)	Case size Φ DxL(mm)	$\tan \delta$ (%)	Ripple current (mA/rms 125°C) (120Hz)
10(13)	100	8X6.2	0.26	75	35(44)	10	8x6.2	0.14	40
	150	6.3x7.7	0.26	70			8x10.2	0.14	50
		8x6.2	0.26	75		22	6.3x7.7	0.14	70
	220	8x10.2	0.26	130			33	6.3x7.7	0.14
	330	8x10.2	0.26	130		8x6.2		0.14	75
		470	8x10.2	0.26		130	47	6.3x7.7	0.14
	10x10.2		0.26	180		8X6.2		0.14	75
	680	10x10.2	0.26	180		8x10.2	0.14	130	
1000	10x10.2	0.26	180	100		8x10.2	0.14	130	
16(20)	47	6.3x7.7	0.20			70	10x10.2	0.14	180
		6.3x7.7	0.20			70	120	8x10.2	0.14
	100	8x6.2	0.20			75		150	10x10.2
		8x10.2	0.20	130		220	10x10.2		0.14
	220	8x10.2	0.20	130			50(63)	10	8x6.2
	330	8x10.2	0.20	180	22	8x10.2			0.12
		470	10x10.2	0.20		180		6.3x7.7	0.12
25(32)	47		6.3x7.7	0.18	70	8x6.2		0.12	75
		8x6.2	0.18	75	33	8x10.2		0.12	130
	100	6.3x7.7	0.18	70		47		8x10.2	0.12
		8x6.2	0.18	75	82			8x10.2	0.12
		8x10.2	0.18	130		100	10x10.2	0.12	180
	150	8x10.2	0.18	130	150		10x10.2	0.12	180
		8x10.2	0.18	130		220	10x10.2	0.12	180
	220	10x10.2	0.18	180					
		330	10x10.2	0.18	180				

Jamicon Series : ST

Teapo Series : S5 Low Profile Series

- Endurance: 105°C 1000hours
- Recommended Applications :Applicable for VTR,Camera,Car Audio,Miniaudio and other industrial/commrecial applications
- Corresponding product to RoHS



SPECIFICATIONS

Item	Characteristics																						
Category Temperature Range	-40~ +105°C																						
Rated Voltage Range	6.3 ~ 50VDC																						
Rated Capacitance Range	1 ~ 470 µF																						
Capacitance Tolerance	± 20 % at 120Hz , 20°C																						
Leakage Current (20°C)	I=0.01CV or 3(µA) whichever is greater.(After rated voltage applied for 2 minutes) I : Max. leakage current (µA), C : Nominal capacitance (µF), V : Rated voltage (V)																						
Dissipation Factor(MAX) (tan δ) (120Hz ,20°C)	<table border="1"> <tr> <td>WV</td> <td>6.3</td> <td>10</td> <td>16</td> <td>25</td> <td>35</td> <td>50</td> </tr> <tr> <td>tan δ</td> <td>0.24</td> <td>0.20</td> <td>0.17</td> <td>0.15</td> <td>0.12</td> <td>0.10</td> </tr> </table>	WV	6.3	10	16	25	35	50	tan δ	0.24	0.20	0.17	0.15	0.12	0.10								
WV	6.3	10	16	25	35	50																	
tan δ	0.24	0.20	0.17	0.15	0.12	0.10																	
Low Temperature Stability Impedance Ratio (MAX)	<table border="1"> <tr> <td rowspan="3">Z(120Hz) Z-25°C / Z+20°C Z-40°C / Z+20°C</td> <td>WV</td> <td>6.3</td> <td>10</td> <td>16</td> <td>25</td> <td>35</td> <td>50</td> </tr> <tr> <td></td> <td>4</td> <td>3</td> <td>2</td> <td>2</td> <td>2</td> <td>2</td> </tr> <tr> <td></td> <td>8</td> <td>6</td> <td>4</td> <td>4</td> <td>3</td> <td>3</td> </tr> </table>	Z(120Hz) Z-25°C / Z+20°C Z-40°C / Z+20°C	WV	6.3	10	16	25	35	50		4	3	2	2	2	2		8	6	4	4	3	3
Z(120Hz) Z-25°C / Z+20°C Z-40°C / Z+20°C	WV		6.3	10	16	25	35	50															
			4	3	2	2	2	2															
		8	6	4	4	3	3																
Endurance	After applying rated voltage with ripple current for 1000 hours at 105°C , the capacitors shall meet the following requirements. <table border="1"> <tr> <td>Capacitance change</td> <td>Within ± 25% of initial value</td> </tr> <tr> <td>D.F. (tan δ)</td> <td>Not more than 200% of specified value</td> </tr> <tr> <td>Leakage current</td> <td>initial specified value or less</td> </tr> </table>	Capacitance change	Within ± 25% of initial value	D.F. (tan δ)	Not more than 200% of specified value	Leakage current	initial specified value or less																
Capacitance change	Within ± 25% of initial value																						
D.F. (tan δ)	Not more than 200% of specified value																						
Leakage current	initial specified value or less																						
Shelf Life	The following specifications shall be satisfied when the capacitors are restored to 20°C after exposing them for 500 hours at 105°C without voltage applied. Before the measurement, the capacitor shall be preconditioned by applying voltage according to item 4.1 of JIS C 5101-4.																						

Dimensions [mm]

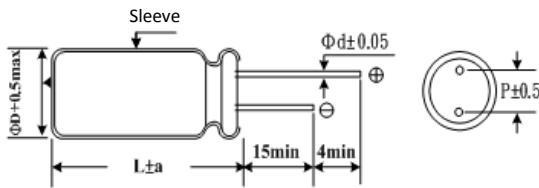

ΦD	4.0	5.0	6.3	8.0
P	1.5	2.0	2.5	3.5
Φd	0.45			
a	1.0			

Notes : 8Φ have ven

Multiplier for Ripple Current

Freq. (Hz)	120	300	1K	10K
1~47 µF	1.00	1.20	1.30	1.50
100~470 µF	1.00	1.10	1.15	1.20

Jamicon Series : ST

Teapo Series : S5

■ STANDARD RATINGS

Rated Voltage (SurageVoltage) (V)	Cap (μ F)	Case size Φ D \times L(mm)	tan δ	Ripple current (mA/rms105°C) (120Hz)	Rated Voltage (SurageVoltage) (V)	Cap (μ F)	Case size Φ D \times L(mm)	tan δ	Ripple current (mA/rms105°C) (120Hz)		
6.3 (8)	10	4x5	0.24	18	16 (20)	47	5x5	0.17	54		
	22	4x5	0.24	28			6.3x5	0.17	58		
	33	4x5	0.24	33			6.3x5	0.17	85		
	10 (13)	47	4x5	0.24	35	25 (32)	100	4x5	0.15	16	
			5x5	0.24	45			4.7	4x5	0.15	20
		100	5x5	0.24	55			10	4x5	0.15	27
			6.3x5	0.24	70			22	6.3x5	0.15	42
			220	6.3x5	0.24			90	33	5x5	0.15
		330	8x5	0.24	115			6.3x5		0.15	53
470		8x5	0.24	100	47			5x5		0.15	55
16 (20)		10	4x5	0.20	20			6.3x5	0.15	65	
	22	5x5	0.20	33	100			8x5	0.15	90	
	33	4x5	0.20	34	35 (44)	4.7	4x5	0.12	18		
		5x5	0.20	41			10	5x5	0.12	30	
	47	5x5	0.20	46			22	6.3x5	0.12	48	
	16 (20)	68	6.3x5	0.20	54	50 (63)	1.0	4x5	0.10	9	
100		6.3x5	0.20	80	2.2			4x5	0.10	13	
4.7		4x5	0.17	20	3.3			4x5	0.10	17	
10		4x5	0.17	23	4.7			4x5	0.10	17	
22		4x5	0.17	29				5x5	0.10	20	
22		5x5	0.17	37				10	6.3x5	0.10	33
33		5x5	0.17	44	22			6.3x5	0.10	55	
	6.3x5	0.17	49								

Jamicon Series : SH

Teapo Series : S7 Low profice Series

- Endurance: 105°C 1000 hours
- Recommended Applications :For Portable Micro Computer, Disk Driver, Small Calculator and Audio equipmeng...etc
- Corresponding product to RoHS



SPECIFICATIONS

Item	Characteristics							
Category Temperature Range	-40 ~ +105°C							
Rated Voltage Range	6.3 ~ 63VDC							
Rated Capacitance Range	1 ~ 470 µF							
Capacitance Tolerance	± 20 % (120Hz , 20°C)							
Leakage Current (20°C)	I=0.01CV or 3(µA) whichever is greater.(After rated voltage applied for 2 minutes) I : Max. leakage current (µA), C : Nominal capacitance (µF), V : Rated voltage (V)							
Dissipation Factor(MAX) (tan δ) (120Hz, 20°C)	WV	6.3	10	16	25	35	50	63
	tan δ	0.24	0.21	0.18	0.15	0.13	0.12	0.08
Low Temperature Stability Impedance Ratio (MAX)	Z(120Hz)	6.3	10	16	25	35	50	63
	Z-25°C / Z+20°C	4	3	2	2	2	2	2
	Z-40°C / Z+20°C	8	6	4	4	3	3	3
Endurance	After applying rated voltage with ripple current for 1000 hours at 105°C , the capacitors shall meet the following requirements.							
	Capacitance change	Within ± 20% of initial value						
	D.F. (tan δ)	Not more than 200% of specified value						
Shelf Life	The following specifications shall be satisfied when the capacitors are restored to 20°C after exposing them for 500 hours at 105°C without voltage applied. Before the measurement, the capacitor shall be preconditioned by applying voltage according to item 4.1 of JIS C 5101-4.							
	Leakage current							

Dimensions [mm]

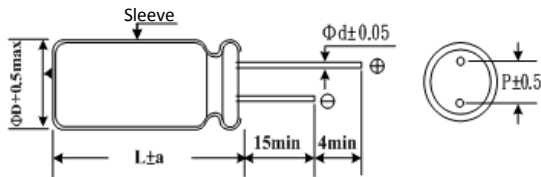

ΦD	4.0	5.0	6.3	8.0
P	1.5	2.0	2.5	3.5
Φd	0.45			0.5
a	1.0			

Notes : 8 Φ have ven

Multiplier for Ripple Current

Freq. (Hz)	50	120	300	1K	10K
1~47 µF	0.75	1.00	1.20	1.30	1.50
100~330 µF	0.75	1.00	1.10	1.15	1.20

Jamicon Series : SH

Teapo Series : S7

■ STANDARD RATINGS

Rated Voltage (SurageVoltage) (V)	Cap (μ F)	Case size Φ D \times L(mm)	$\tan \delta$	Ripple current (mA/rms105°C) (120Hz)	Rated Voltage (SurageVoltage) (V)	Cap (μ F)	Case size Φ D \times L(mm)	$\tan \delta$	Ripple current (mA/rms105°C) (120Hz)
6.3 (8)	22	4x7	0.24	37	25 (32)	4.7	4x7	0.15	24
	33	5x7	0.24	42		10	4x7	0.15	33
	47	4x7	0.24	46			5x7	0.15	35
		5x7	0.24	55			6.3x7	0.15	35
	100	5x7	0.24	75		22	4x7	0.15	43
		6.3x7	0.24	90			5x7	0.15	51
	220	6.3x7	0.24	130		6.3x7	0.15	53	
330	8x7	0.24	140	33		5x7	0.15	55	
10 (13)	22	4x7	0.21			31	6.3x7	0.15	65
		5x7	0.21			38	47	5x7	0.15
	33	4x7	0.21	39		6.3x7		0.15	79
		5x7	0.21	47		100	6.3x7	0.15	120
	47	4x7	0.21	50	8x7		0.15	120	
		5x7	0.21	60	35 (44)		4.7	4x7	0.13
	100	6.3x7	0.21	60		10	5x7	0.13	24
5x7		0.21	85	4x7			0.13	34	
220	6.3x7	0.21	100	22		5x7	0.13	36	
	6.3x7	0.21	135			5x7	0.13	48	
16 (20)	2.2	4x7	0.18	7		33	6.3x7	0.13	57
	3.3	4x7	0.18	13		47	6.3x7	0.13	70
	4.7	4x7	0.18	19	6.3x7		0.13	81	
	10	4x7	0.18	29	50 (63)	1.0	4x7	0.12	10
	22	4x7	0.18	36		2.2	4x7	0.12	19
		5x7	0.18	44		3.3	4x7	0.12	24
	33	4x7	0.18	50		4.7	4x7	0.12	29
		5x7	0.18	57			5x7	0.12	31
	47	5x7	0.18	75		10	4x7	0.12	37
		6.3x7	0.18	77			5x7	0.12	45
	68	5x7	0.18	84	6.3x7		0.12	45	
	100	5x7	0.18	94	22	6.3x7	0.12	65	
		6.3x7	0.18	110	63 (79)	1.0	4x7	0.08	13
	150	6.3x7	0.18	120		2.2	4x7	0.08	21
	220	8x7	0.18	140		3.3	4x7	0.08	26
		8x9	0.18	140		4.7	4x7	0.08	26
	330	8x9	0.18	155			6.3x7	0.08	33
		470	8x9	0.18		165	10	5x7	0.08
	6.3x7		0.08	50					

Jamicon Series : H5

Teapo Series : H5 Low profice Series

- Endurance: 105°C 2000hours
Low proglie/minianure,5mm height
- Recommended Applications :Monitor/Compuer,AV(TV,Video,Audio),
OA/HA/Communication,Small signal
- Corresponding product to RoHS



■ SPECIFICATIONS

Item	Characteristics						
Category Temperature Range	-40 ~ +105°C						
Rated Voltage Range	6.3~ 50VDC						
Rated Capacitance Range	1 ~ 330 μF						
Capacitance Tolerance	± 20 % at 120Hz , 20°C						
Leakage Current (20°C)	I=0.01CV or 3(μA) whichever is greater.(After rated voltage applied for 2 minutes) I : Max. leakage current (μA), C : Nominal capacitance (μF), V : Rated voltage (V)						
Dissipation Factor(MAX) (tan δ) (120Hz,20°C)	WV	6.3	10	16	25	35	50
	tan δ	0.26	0.24	0.20	0.16	0.13	0.12
Low Temperature Stability Impedance Ratio (MAX)	Down size tan δ add 3%						
	WV	6.3	10	16	25	35	50
	Z(120Hz)	4	3	2	2	2	2
Endurance	After applying rated voltage with ripple current for 2000 hours at 105°C , the capacitors shall meet the following requirements.						
	Capacitance change	Within ± 20% of initial value					
Shelf Life	D.F. (tan δ)	Not more than 200% of specified value					
	Leakage current	initial specified value or less					
Shelf Life	The following specifications shall be satisfied when the capacitors are restored to 20°C after exposing them for 1,000 hours at 105°C without voltage applied. Before the measurement, the capacitor shall be preconditioned by applying voltage according to item 4.1 of JIS C 5101-4.						

■ Dimensions [mm]

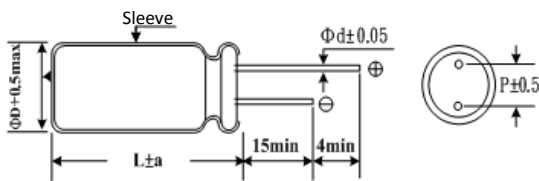

ΦD	4.0	5.0	6.3	8.0
P	1.5	2.0	2.5	3.5
Φd	0.45	0.45	0.45	0.45
a	1.0	1.0	1.0	1.0

Notes : 8 Φ have ven

■ Multiplier for Ripple Current

Freq. (Hz)	50	120	1K	10K
6.3~16V	0.80	1.00	1.10	1.20
25~50V	0.80	1.00	1.50	1.70

Jamicon Series : H5

Teapo Series : H5

■ STANDARD RATINGS

Rated Voltage (SurageVoltage) (V)	Cap (μ F)	Case size Φ DxL(mm)	$\tan \delta$	Ripple current (mA/rms105°C) (120Hz)	Rated Voltage (SurageVoltage) (V)	Cap (μ F)	Case size Φ DxL(mm)	$\tan \delta$	Ripple current (mA/rms105°C) (120Hz)
6.3 (8)	10	4x5	0.26	15	16 (20)	47	6.3x5	0.20	55
	22	4x5	0.26	25		100	6.3x5	0.2	90
	33	5x5	0.26	30	25 (32)	4.7	4x5	0.16	15
	47	5x5	0.26	35		10	4x5	0.16	25
	100	6.3x5	0.26	60		22	6.3x5	0.16	40
	220	8x5	0.26	95		33	6.3x5	0.16	50
	330	8x5	0.26	120	35 (44)	4.7	4x5	0.13	15
10 (13)	10	4x5	0.24	20		10	5x5	0.13	30
	22	5x5	0.24	25		22	6.3x5	0.13	45
	33	5x5	0.24	35	50 (63)	1.0	4x5	0.12	10
	47	6.3x5	0.24	45		2.2	4x5	0.12	15
	100	6.3x5	0.24	70		3.3	4x5	0.12	15
16 (20)	4.7	4x5	0.20	10		4.7	5x5	0.12	20
	10	4x5	0.20	20		10	6.3x5	0.12	35
	22	5x5	0.20	30		22	6.3x5	0.12	55
	33	5x5	0.20	40					

Jamicon Series : H7

Teapo Series : H7 Low profile Series

- Endurance:105°C 2000 hours
Low profile/miniature,7mm/9mm height
- Recommended Applications :Monitor/Compuer,AV(TV,Video,Audio),
OA/HA/Communication,Small signal
- Corresponding product to RoHS



SPECIFICATIONS

Item	Characteristics																							
Category Temperature Range	-40 ~ +105°C																							
Rated Voltage Range	6.3 ~ 63VDC																							
Rated Capacitance Range	1 ~ 470 μF																							
Capacitance Tolerance	± 20 % at 120Hz , 20°C																							
Leakage Current (20°C)	I=0.01CV or 3(μA) whichever is greater.(After rated voltage applied for 2 minutes) I : Max. leakage current (μA), C : Nominal capacitance (μF), V : Rated voltage (V)																							
Dissipation Factor(MAX) (tan δ) (120Hz, 20°C)	<table border="1"> <tr> <td>WV</td> <td>6.3</td> <td>10</td> <td>16</td> <td>25</td> <td>35</td> <td>50</td> <td>63</td> </tr> <tr> <td>tan δ</td> <td>0.24</td> <td>0.20</td> <td>0.18</td> <td>0.15</td> <td>0.13</td> <td>0.12</td> <td>0.10</td> </tr> </table> <p>Down size tan δ add 3%</p>	WV	6.3	10	16	25	35	50	63	tan δ	0.24	0.20	0.18	0.15	0.13	0.12	0.10							
WV	6.3	10	16	25	35	50	63																	
tan δ	0.24	0.20	0.18	0.15	0.13	0.12	0.10																	
Low Temperature Stability Impedance Ratio (MAX)	<table border="1"> <tr> <td rowspan="3">Z(120Hz) Z-25°C / Z+20°C Z-40°C / Z+20°C</td> <td>WV</td> <td>6.3</td> <td>10</td> <td>16</td> <td>25</td> <td>35</td> <td>50</td> <td>63</td> </tr> <tr> <td>4</td> <td>3</td> <td>2</td> <td>2</td> <td>2</td> <td>2</td> <td>2</td> </tr> <tr> <td>8</td> <td>6</td> <td>4</td> <td>4</td> <td>4</td> <td>4</td> <td>4</td> </tr> </table>	Z(120Hz) Z-25°C / Z+20°C Z-40°C / Z+20°C	WV	6.3	10	16	25	35	50	63	4	3	2	2	2	2	2	8	6	4	4	4	4	4
Z(120Hz) Z-25°C / Z+20°C Z-40°C / Z+20°C	WV		6.3	10	16	25	35	50	63															
	4		3	2	2	2	2	2																
	8	6	4	4	4	4	4																	
Endurance	After applying rated voltage with ripple current for 2000 hours at 105°C , the capacitors shall meet the following requirements. <table border="1"> <tr> <td>Capacitance change</td> <td>Within ± 20% of initial value</td> </tr> <tr> <td>D.F. (tan δ)</td> <td>Not more than 200% of specified value</td> </tr> <tr> <td>Leakage current</td> <td>initial specified value or less</td> </tr> </table>	Capacitance change	Within ± 20% of initial value	D.F. (tan δ)	Not more than 200% of specified value	Leakage current	initial specified value or less																	
Capacitance change	Within ± 20% of initial value																							
D.F. (tan δ)	Not more than 200% of specified value																							
Leakage current	initial specified value or less																							
Shelf Life	The following specifications shall be satisfied when the capacitors are restored to 20°C after exposing them for 1,000 hours at 105°C without voltage applied. Before the measurement, the capacitor shall be preconditioned by applying voltage according to item 4.1 of JIS C 5101-4.																							

Dimensions [mm]

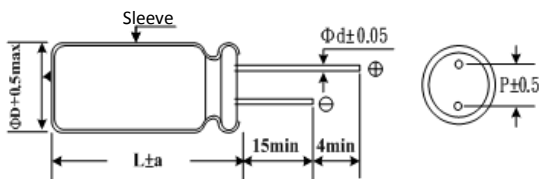

ΦD	4.0	5.0	6.3	8.0
P	1.5	2.0	2.5	3.5
Φd	0.45	0.45	0.45	0.5
a	1.0	1.0	1.0	1.0

Notes : 8 Φ have ven

Multiplier for Ripple Current

Freq. (Hz)	50	120	1K	10K
6.3~16V	0.80	1.00	1.1	1.2
25~35V	0.80	1.00	1.5	1.7
50~63V	0.80	1.00	1.6	1.9

Jamicon Series : H7

Teapo Series : H7

■ STANDARD RATINGS

Rated Voltage (SurageVoltage) (V)	Cap (μ F)	Case size Φ DxL(mm)	$\tan \delta$	Ripple current (mA/rms105°C) (120Hz)	Rated Voltage (SurageVoltage) (V)	Cap (μ F)	Case size Φ DxL(mm)	$\tan \delta$	Ripple current (mA/rms105°C) (120Hz)
6.3 (8)	33	4x7	0.24	35	25 (32)	4.7	4x7	0.15	20
	47	5x7	0.24	50		10	4x7	0.15	30
	100	5x7	0.24	70		22	5x7	0.15	50
	220	6.3x7	0.24	110		33	6.3x7	0.15	65
	330	8x7	0.24	150		47	6.3x7	0.15	70
	470	8x9	0.24	200		100	8x7	0.15	115
10 (13)	22	4x7	0.20	30	35 (44)	4.7	4x7	0.13	25
	33	4x7	0.20	40		10	4x7	0.13	35
	47	5x7	0.20	60		22	5x7	0.13	60
	100	6.3x7	0.20	90		33	6.3x7	0.13	70
	220	6.3x7	0.20	135		47	8x7	0.13	80
	330	8x9	0.20	160		100	8x9	0.13	145
16 (20)	2.2	4x7	0.18	10	50 (63)	1.0	4x7	0.12	10
	3.3	4x7	0.18	10		2.2	4x7	0.12	20
	4.7	4x7	0.18	15		3.3	4x7	0.12	25
	10	4x7	0.18	25		4.7	4x7	0.12	30
	22	4x7	0.18	35		10	5x7	0.12	35
	33	5x7	0.18	50		22	6.3x7	0.12	65
	47	6.3x7	0.18	70		33	8x7	0.12	80
	100	6.3x7	0.18	110		47	8x9	0.12	100
	220	8x9	0.18	180	63 (79)	1.0	4x7	0.10	10
	330	8x9	0.18	210		2.2	4x7	0.10	20
				3.3		4x7	0.10	25	
				4.7		5x7	0.10	35	
					10	6.3x7	0.10	50	

Jamicon Series : SK

Teapo Series : SK Standard Series

550V
LINE
UP

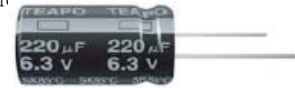

- Endurance: 85°C 2000hours
- Recommended Applications :For general purpose , decoupling , by pass and filtering circuit in entertainment electri
- Corresponding product to RoHS

SPECIFICATIONS

Item	Characteristics										
	-40~+85°C			-40~+85°C				-25~+85°C			
Category Temperature Range	-40~+85°C			-40~+85°C				-25~+85°C			
Rated Voltage Range	6.3 ~ 100VDC			160 ~ 450VDC				500~550VDC			
Rated Capacitance Range	1~ 22000 μF			1 ~ 470 μF				2.2~82 μF			
Capacitance Tolerance	± 20 % (120Hz , 20°C)			± 20 % (120Hz , 20°C)				± 20 % (120Hz , 20°C)			
Leakage Current (20°C)	I=0.01CV or 3 μ A whichever is greater.			I=0.03CV+10(μ A)				I=0.03CV+10(μ A)			
	(After rated voltage applied for 2 minutes) I : Max. leakage current (μ A), C : Nominal capacitance (μ F), V : Rated voltage (V)										
Dissipation Factor(MAX) (tan δ) (120Hz ,20°C)	WV	6.3	10	16	25	35~40	50~63	100	160~250	350~450	500~550
	tan δ	0.22	0.19	0.16	0.14	0.12	0.10	0.08	0.15	0.20	0.24
When nominal capacitance is over 1000 μ F,tan δ shall be added 0.02 to the listed value with increase of every 1000 μ F.											
Low Temperature Stability Impedance Ratio (MAX)	Z(120Hz)	6.3	10	16	25	35~100	160~250	315~350	400~550		
	Z-25°C / Z+20°C	8	6	5	3	3	7	10	15		
	Z-40°C / Z+20°C	10	8	6	4	3	—	—	—		
Endurance	After applying rated voltage for 2000 hours at 85°C,Stay back to 20 °C temperature measurement, the capacitors shall meet the following requirements.										
	Capacitance change	Within ± 20% of initial value									
	D.F. (tan δ)	Not more than 200% of specified value									
Shelf Life	The following specifications shall be satisfied when the capacitors are restored to 20°C after exposing them for1,000 hours at 85°C without voltage applied. Before the measurement, the capacitor shall be preconditioned by applying voltage according to item 4.1 of JIS C 5101-4.										
	Leakage current	initial specified value or less									

Dimensions [mm]

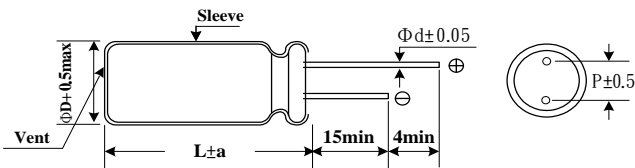

ΦD	5	6.3	8	10	13	16	18	22
P	2.0	2.5	3.5	5.0	5.0	7.5	7.5	10.0
Φd	0.5	0.5	0.6	0.6	0.6	0.8	0.8	1.0
a	1.5	1.5	1.5	1.5	2.0	2.0	2.0	2.0

Multiplier for Ripple Current

Freq. (Hz)	60	120	1K	≥10K
6.3~25V	0.85	1.00	1.10	1.20
35 ~ 100V	0.80	1.00	1.15	1.25
160 ~ 200V	0.75	1.00	1.25	1.40
350 ~ 450V	0.70	1.00	1.30	1.50
500~550V	0.60	1.00	1.10	1.15

Jamicon Series : SK

Teapo Series : SK

■ STANDARD RATINGS

Rated Voltage (SurageVoltage) (V)	Cap (μF)	Case size Φ DxL(mm)	tan δ	Ripple current (mA/rms85°C) (120Hz)	Rated Voltage (SurageVoltage) (V)	Cap (μF)	Case size Φ DxL(mm)	tan δ	Ripple current (mA/rms85°C) (120Hz)	
6.3 (8)	22	5x11	0.22	50	25 (32)	220	8x11	0.14	390	
	33	5x11	0.22	65		330	8x11	0.14	480	
	47	5x11	0.22	105		470	8x15	0.14	530	
	100	5x11	0.22	160			10x12.5	0.14	600	
	220	5x11	0.22	240		680	10x15	0.14	760	
		6.3x11	0.22	270			1000	10x20	0.14	1080
	330	6.3x11	0.22	330		13x16		0.14	1070	
	470	6.3x11	0.22	390		2200	13x25	0.16	1760	
	680	8x11	0.22	520		3300	16x25	0.18	2040	
	1000	8x11	0.22	670		4700	16x32	0.20	2500	
		10x12.5	0.22	700			6800	18x36	0.24	3100
	2200	10x20	0.24	1220		10000	22x40	0.32	3700	
	3300	10x20	0.26	1440		15000	22x40	0.42	3980	
	4700	13x20	0.28	1730			35 (44)	10	5x11	0.12
	6800	13x25	0.32	2160		22		5x11	0.12	100
	10000	16x25	0.40	2390		33		5x11	0.12	120
15000	16x36	0.50	3050	47	5x11	0.12		150		
10 (13)	22000	18x40	0.64	3680	100	6.3x11		0.12	240	
	10	5x11	0.19	50	220	8x11		0.12	420	
	22	5x11	0.19	60	330	10x12.5		0.12	550	
	33	5x11	0.19	80	470	10x15		0.12	700	
	47	5x11	0.19	110		680		10x20	0.12	900
	100	5x11	0.19	180	1000	13x20		0.12	1240	
	220	6.3x11	0.19	290	2200	16x25		0.14	1890	
	330	6.3x11	0.19	350	3300	16x36		0.16	2530	
	470	6.3x11	0.19	420		18x32		0.16	2450	
	680	8x11	0.19	520	4700	18x36		0.18	2960	
	1000	10x12.5	0.19	760		6800		22x40	0.22	3600
	2200	10x20	0.21	1310	50 (63)	10		5x11	0.10	75
	3300	13x20	0.23	1630		22	5x11	0.10	110	
	4700	13x25	0.25	2020		33	5x11	0.10	140	
	6800	16x25	0.29	2270		47	6.3x11	0.10	180	
		16x36	0.37	2900			100	8x11	0.10	310
10000	18x32	0.37	3000	220		10x12.5	0.10	490		
	15000	18x36	0.47			3360	330	10x15	0.10	650
22000	22x40	0.59	4000	470		10x20	0.10	820		
16 (20)	10	5x11	0.16			50	1000	13x25	0.10	1500
	22	5x11	0.16	75		2200	16x36	0.12	2390	
	33	5x11	0.16	110			18x32	0.12	2400	
	47	5x11	0.16	130		3300	18x36	0.14	2890	
	68	5x11	0.16	150			4700	22x40	0.16	3500
	100	5x11	0.16	175		63 (79)	10	5x11	0.10	75
	150	6.3x11	0.16	245			22	5x11	0.10	110
	220	6.3x11	0.16	310				6.3x11	0.10	130
	330	6.3x11	0.16	360	33		6.3x11	0.10	150	
		8x11	0.16	450			47	6.3x11	0.10	190
	470	8x11	0.16	540	100		10x12.5	0.10	330	
	680	10x12.5	0.16	700			220	10x15	0.10	520
	1000	10x16	0.16	920	10x20			0.10	600	
	2200	13x20	0.18	1510	330		10x20	0.10	730	
	3300	13x25	0.20	1930			470	13x20	0.10	930
	4700	16x25	0.22	2160	680		13x25	0.10	1200	
6800	16x32	0.26	2650	1000	16x25		0.10	1510		
	10000	18x36	0.34		3230		2200	18x36	0.12	2350
15000	22x40	0.44	4090	3300	22x40		0.14	3200		
22000	22x40	0.58	4200		100 (125)		10	5x11	0.08	80
25 (32)	10	5x11	0.14	60			22	6.3x11	0.08	95
	22	5x11	0.14	95		6.3x11		0.08	140	
	33	5x11	0.14	115		33	8x11	0.08	160	
	47	5x11	0.14	140			8x11	0.08	200	
	68	5x11	0.14	150		47	10x12.5	0.08	250	
	100	6.3x11	0.14	230			10x15	0.08	315	

Jamicon Series : SK

Teapo Series : SK

■ STANDARD RATINGS

Rated Voltage (SurageVoltage) (V)	Cap (μF)	Case size Φ D×L(mm)	tan δ	Ripple current (mA/rms85°C) (120Hz)	Rated Voltage (SurageVoltage) (V)	Cap (μF)	Case size Φ D×L(mm)	tan δ	Ripple current (mA/rms85°C) (120Hz)	
100 (125)	100	10x20	0.08	450	250 (300)	100	16x25	0.15	485	
	150	13x20	0.08	600		150	16x32	0.15	650	
	220	13x25	0.08	790		220	18x36	0.15	900	
	160 (200)	330	13x25	0.08	960	350 (400)	1.0	6.3x11	0.20	25
		470	16x25	0.08	1160		2.2	8x11	0.20	43
		680	16x36	0.08	1500		3.3	8x11	0.20	45
		1000	18x40	0.08	2220		4.7	10x12.5	0.20	65
200 (250)		1	5x11	0.15	20		10	10x15	0.20	100
		2.2	6.3x11	0.15	25		22	13x20	0.20	190
		3.3	6.3x11	0.15	37		33	13x25	0.20	250
		4.7	6.3x11	0.15	45		47	16x25	0.20	300
		10	8x11	0.15	90		100	16x36	0.20	510
		22	10x15	0.15	150		18x32	0.20	520	
		33	10x15	0.15	160	400 (450)	4.7	8x11	0.20	55
		47	10x20	0.15	210		6.8	10x12.5	0.20	65
		68	13x20	0.15	255		8x15	0.20	65	
	100	13x25	0.15	440	10x12.5		0.20	70		
	150	16x25	0.15	570	10		10x15	0.20	100	
	220	16x32	0.15	660	22		13x20	0.20	190	
	330	18x36	0.15	1000	33		13x25	0.20	230	
	470	22x40	0.15	1400	47		16x25	0.20	290	
250 (300)	1	5x11	0.15	22	68		16x32	0.20	370	
	2.2	6.3x11	0.15	39	18x25		0.20	350		
	3.3	6.3x11	0.15	48	100	18x32	0.20	515		
	4.7	6.3x11	0.15	55	150	18x40	0.20	700		
	6.8	8x11	0.15	70	450 (500)	2.2	10x12.5	0.20	45	
	10	8x11	0.15	80		3.3	10x12.5	0.20	52	
	22	10x15	0.15	160		4.7	10x12.5	0.20	58	
	33	10x20	0.15	210		6.8	10x15	0.20	70	
	47	10x20	0.15	240		10	13x20	0.20	130	
	68	13x20	0.15	290		22	13x25	0.20	185	
	100	16x25	0.15	470		33	16x25	0.20	250	
	220	16x32	0.15	690	47	18x36	0.20	370		
	300 (360)	1	5x11	0.15	23	500(550)	4.7	10x12.5	0.24	40
		2.2	6.3x11	0.15	29		6.8	10x15	0.24	50
3.3		8x11	0.15	43	10		10x20	0.24	70	
4.7		8x11	0.15	48	15		13x16	0.24	90	
6.8		8x11	0.15	60	22		13x25	0.24	130	
10		10x12.5	0.15	105	33		16x25	0.24	200	
22		10x20	0.15	180	47		18x32	0.24	230	
33		13x20	0.15	270	550 (600)	4.7	10x12.5	0.24	45	
47		13x25	0.15	350		6.8	10x15	0.24	55	
350 (420)		1	5x11	0.15		20	10	10x20	0.24	75
		2.2	6.3x11	0.15		25	12	10x20	0.24	85
		3.3	6.3x11	0.15		37	15	13x16	0.24	100
		4.7	6.3x11	0.15		45	18	13x20	0.24	120
		10	8x11	0.15		90	22	13x25	0.24	145
	22	10x15	0.15	150	33	16x30	0.24	215		
	33	10x20	0.15	210	47	18x32	0.24	250		
	47	10x20	0.15	230	68	18x36	0.24	320		
	68	13x20	0.15	255	82	18x40	0.24	360		
	100	13x25	0.15	440						
	150	16x25	0.15	570						
	220	16x32	0.15	660						
	330	18x36	0.15	1000						
	470	22x40	0.15	1400						

Jamicon Series : TK

Teapo Series : SH

Standard Series

550V
LINE
UP



■ Endurance: 105°C 2000hours

■ Recommended Applications :For high quality , reliability application, high CV product

■ Corresponding product to RoHS

SPECIFICATIONS

Item	Characteristics											
	-55~+105°C				-40~+105°C				-25~+105°C			
Category Temperature Range	-55~+105°C				-40~+105°C				-25~+105°C			
Rated Voltage Range	6.3 ~ 100VDC				160 ~ 450VDC				500~550VDC			
Rated Capacitance Range	1~ 22000 μ F				1 ~ 470 μ F				2.2~82 μ F			
Capacitance Tolerance	\pm 20 % (120Hz , 20°C)				\pm 20 % (120Hz , 20°C)				\pm 20 % (120Hz , 20°C)			
Leakage Current (20°C)	I=0.01CV or 3(μ A)whichever is greater.				I=0.03CV+10(μ A)				I=0.04CV+100(uA)			
(After rated voltage applied for 2 minutes)I : Max. leakage current (μ A), C : Nominal capacitance (μ F), V : Rated voltage (V)												
Dissipation Factor(MAX) (tan δ) (120Hz , 20°C)	WV	6.3	10	16	25	35	50	63~80	100	160~250	350~450	500~550
	tan δ	0.24	0.20	0.17	0.15	0.12	0.10	0.10	0.08	0.15	0.20	0.25
When nominal capacitance is over 1000 μ F,tan δ shall be added 0.02 to the listed value with increase of every 1000 μ F.												
Low Temperature Stability Impedance Ratio (MAX)	WV											
	Z(120Hz)	6.3	10	16	25	35~100	160~250	350~400	450	500~550		
	Z-25°C / Z+20°C	4	3	2	2	2	3	4	4	6		
	Z-40°C / Z+20°C	8	6	4	4	3	4	10	—	—		
Endurance	After applying rated voltage with rated ripple current for 2000hours at 105°C , the capacitors shall meet the following requirements.											
	Capacitance change	Within \pm 20% of initial value										
	D.F. (tan δ)	Not more than 200% of specified value										
	Leakage current	initial specified value or less										
Shelf Life	The following specifications shall be satisfied when the capacitors are restored to 20°C after exposing them for1,000 hours at 105°C without voltage applied. Before the measurement, the capacitor shall be preconditioned by applying voltage according to item 4.1 of JIS C 5101-4.											

Dimensions [mm]

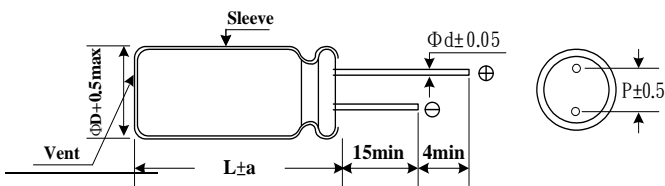

ϕ D	5	6.3	8	10	13	16	18	22	25
p	2.0	2.5	3.5	5.0	7.5	10.0	12.5		
ϕ d	0.5	0.5	0.6	0.6	0.8	1.0	1.0		
a	1.5	1.5	1.5	1.5	2.0	2.0	2.0	2.0	2.0

Multiplier for Ripple Current

Freq. (Hz)	60	120	1K	\geq 10K
6.3~25V	0.85	1.00	1.10	1.20
35 ~ 100V	0.80	1.00	1.15	1.25
160 ~ 200V	0.75	1.00	1.25	1.40
350 ~ 450V	0.70	1.00	1.30	1.80
500~550V	0.60	1.00	1.10	1.15

Jamicon Series : TK

Teapo Series : SH

■ STANDARD RATINGS

Rated Voltage (SurageVoltage) (V)	Cap (μ F)	Case size Φ DxL(mm)	$\tan \delta$	Ripple current (mA/rms105°C) (120Hz)	Rated Voltage (SurageVoltage) (V)	Cap (μ F)	Case size Φ DxL(mm)	$\tan \delta$	Ripple current (mA/rms105°C) (120Hz)
6.3 (8)	100	5x11	0.24	110	25 (32)	470	8x15	0.15	420
	150	5x11	0.24	130			10x12.5	0.15	440
	220	6.3x11	0.24	180		680	10x15	0.15	560
	330	6.3x11	0.24	220		1000	10x20	0.15	790
	470	6.3x11	0.24	270		1500	13x20	0.15	1050
	680	8x11	0.24	375		2200	13x25	0.17	1370
	1000	8x15	0.24	500		3300	16x25	0.19	1500
		10x12.5	0.24	520		4700	16x32	0.21	1990
	1500	10x15	0.24	600		6800	18x36	0.25	2480
	2200	10x20	0.26	850		35 (44)	10	5x11	0.12
	3300	13x20	0.28	1150	15		5x11	0.12	60
	4700	13x20	0.30	1350	22		5x11	0.12	70
	6800	13x25	0.34	1680	33		5x11	0.12	90
	10000	16x32	0.42	2250	47		5x11	0.12	110
	15000	16x36	0.52	2320	68		6.3x11	0.12	140
22000	18x40	0.64	2810	100	6.3x11		0.12	170	
10 (13)	47	5x11	0.20	80	150		8x11	0.12	235
	68	5x11	0.20	95	220		10x12.5	0.12	330
	100	5x11	0.20	120	330		10x12.5	0.12	410
	150	5x11	0.20	130	470		10x15	0.12	530
	220	6.3x11	0.20	190	680		10x20	0.12	720
	330	6.3x11	0.20	250	1000		13x20	0.12	1020
		8x11	0.20	275	1500		13x25	0.12	1350
	470	6.3x11	0.20	290	2200		16x25	0.14	1640
		8x11	0.20	315	3300	16x36	0.16	2070	
	680	8x11	0.20	365	4700	18x36	0.18	2410	
		10x12.5	0.20	420	50 (63)	3.3	5x11	0.10	31
	1000	8x15	0.20	505		4.7	5x11	0.10	36
		10x12.5	0.20	560		6.8	5x11	0.10	40
	1500	10x20	0.20	820		10	5x11	0.10	55
	2200	10x20	0.22	970		15	5x11	0.10	65
3300	13x20	0.24	1280	22		5x11	0.10	80	
4700	13x25	0.26	1590	33		5x11	0.10	95	
6800	16x25	0.30	1940	47		6.3x11	0.10	130	
10000	16x36	0.38	2330	68		8x11	0.10	180	
15000	18x36	0.48	2710	100		8x11	0.10	220	
16 (20)	33	5x11	0.17	75		150	10x12.5	0.10	310
	47	5x11	0.17	90		220	10x12.5	0.10	370
	68	5x11	0.17	105			10x15	0.10	415
	100	5x11	0.17	130		330	10x20	0.10	535
	150	6.3x11	0.17	180		470	10x20	0.10	660
	220	6.3x11	0.17	220	13x20		0.10	760	
	330	8x11	0.17	310	680	13x20	0.10	850	
	470	8x11	0.17	375	1000	13x25	0.10	1210	
	680	8x15	0.17	465	1500	16x25	0.10	1500	
		10x12.5	0.17	485	2200	16x32	0.12	1850	
	1000	10x15	0.17	650		16x36	0.12	1950	
	1500	10x20	0.17	900	3300	18x36	0.14	2360	
	2200	13x20	0.19	1180	4700	18x45	0.16	2500	
	3300	13x25	0.21	1510	63 (79)	10	5x11	0.10	55
	4700	16x25	0.23	1830		15	5x11	0.10	65
6800	16x32	0.27	2120	22		6.3x11	0.10	90	
10000	18x36	0.35	2590	33		6.3x11	0.10	110	
22	5x11	0.15	65	47		8x11	0.10	155	
33	5x11	0.15	80	68		10x12.5	0.10	205	
47	5x11	0.15	95	100		10x12.5	0.10	260	
68	6.3x11	0.15	125	150		10x15	0.10	330	
100	6.3x11	0.15	160	220		10x20	0.10	465	
150	8x11	0.15	220	330		13x20	0.10	650	
220	8x11	0.15	270	470	13x20	0.10	750		
25 (32)	330	8x11	0.15	330	680	16x25	0.10	1000	
		10x12.5	0.15	375	1000	16x32	0.10	1380	

Jamicon Series : TK

Teapo Series : SH

■ STANDARD RATINGS

Rated Voltage (SurageVoltage) (V)	Cap (μ F)	Case size Φ DxL(mm)	$\tan \delta$	Ripple current (mA/rms105°C) (120Hz)	Rated Voltage (SurageVoltage) (V)	Cap (μ F)	Case size Φ DxL(mm)	$\tan \delta$	Ripple current (mA/rms105°C) (120Hz)
63 (79)	1500	16x36	0.10	1650	350 (400)	3.3	8x11	0.20	37
	2200	18x36	0.12	2080		4.7	8x11	0.20	45
100 (125)	10	6.3x11	0.08	65		10	10x15	0.20	80
	15	6.3x11	0.08	75		22	13x20	0.20	150
	22	8x11	0.08	115		33	13x25	0.20	200
	33	8x11	0.08	140		47	16x25	0.20	260
	47	10x12.5	0.08	190	100	18x32	0.20	410	
	68	10x15	0.08	240	400 (450)	1	6.3x11	0.20	17
	100	10x20	0.08	340		2.2	8x11	0.20	32
	150	13x20	0.08	480		3.3	8x11	0.20	39
	220	13x25	0.08	630		4.7	8x11	0.20	46
	330	16x25	0.08	830			10x12.5	0.20	55
470	16x32	0.08	1000	6.8		8x15	0.20	60	
680	16x36	0.08	1200			10x12.5	0.20	65	
160 (200)	1	5x11	0.15	17		10	10x15	0.20	85
	2.2	6.3x11	0.15	26		15	10x20	0.20	100
	3.3	6.3x11	0.15	36		22	13x20	0.20	155
	4.7	6.3x11	0.15	43		33	13x25	0.20	200
	6.8	8x11	0.15	54		47	16x25	0.20	270
	10	8x11	0.15	70		68	16x32	0.20	410
	15	10x12.5	0.15	90			18x25	0.20	390
	22	10x15	0.15	115	100	18x32	0.20	500	
	33	10x20	0.15	160	120	18x32	0.20	520	
	47	10x20	0.15	195		18x36	0.20	550	
	68	13x20	0.15	260	150	18x40	0.20	620	
	100	13x25	0.15	350	420 (470)	1	6.3x11	0.20	17
	150	16x25	0.15	435		2.2	8x11	0.20	29
	220	16x32	0.15	560		3.3	8x11	0.20	34
330	18x36	0.15	800	4.7		10x12.5	0.20	55	
470	18x40	0.15	970	6.8		10x15	0.20	68	
200 (250)	1	6.3x11	0.15	19		10	10x20	0.20	98
	2.2	6.3x11	0.15	28		15	13x20	0.20	130
	3.3	6.3x11	0.15	36		22	13x25	0.20	155
	4.7	8x11	0.15	50		33	16x25	0.20	205
	6.8	8x11	0.15	60		47	16x25	0.20	235
	10	10x12.5	0.15	80		68	16x32	0.20	400
	15	10x15	0.15	110			18x25	0.20	380
	22	10x20	0.15	140		100	18x36	0.20	490
	33	13x20	0.15	200		120	18x40	0.20	530
	47	13x20	0.15	245	150	18x45	0.20	570	
	68	13x25	0.15	310	450 (500)	1.0	6.3x11	0.20	18
	100	16x25	0.15	390			8x11	0.20	22
	150	16x32	0.15	480		2.2	8x11	0.20	30
	220	16x36	0.15	675			10x12.5	0.20	37
	330	18x32	0.15	685		3.3	8x15	0.20	42
		18x36	0.15	840			10x12.5	0.20	40
250 (300)	1	6.3x11	0.15	21		4.7	10x12.5	0.20	52
	2.2	6.3x11	0.15	31		6.8	10x15	0.20	62
	3.3	8x11	0.15	44		10	10x20	0.20	85
	4.7	8x11	0.15	52		15	13x20	0.20	120
	6.8	8x11	0.15	62	22	13x25	0.20	160	
	10	10x12.5	0.15	85	33	16x25	0.20	210	
	15	10x15	0.15	110	47	16x25	0.20	260	
	22	10x20	0.15	140	68	18x32	0.20	370	
	33	13x20	0.15	210	100	18x36	0.20	495	
	47	13x25	0.15	280	120	18x40	0.20	565	
	68	13x25	0.15	310	150	18x45	0.20	650	
	100	16x25	0.15	420	500 (550)	2.2	8x11	0.25	25
	150	16x32	0.15	550		3.3	8x16	0.25	30
	220	18x36	0.15	740		4.7	8x16	0.25	34
350 (400)	1	6.3x11	0.20	18			10x12.5	0.25	38
	2.2	8x11	0.20	31		6.8	10x15	0.25	50

Jamicon Series : TK

Teapo Series : SH

■ STANDARD RATINGS

Rated Voltage (SurageVoltage) (V)	Cap (μF)	Case size Φ D \times L(mm)	tan δ	Ripple current (mA/rms105 $^{\circ}$ C) (120Hz)
500 (550)	8.2	10x16	0.25	60
	10	10x20	0.25	70
		13x16	0.25	80
		13x20	0.25	90
	18	13x20	0.25	100
	22	13x25	0.25	115
		16x20	0.25	120
	33	18x25	0.25	180
	47	16x32	0.25	180
		18x30	0.25	230
	68	18x32	0.25	250
82	18x40	0.25	335	
550 (600)	4.7	10x12.5	0.25	35
	5.6	10x12.5	0.25	45
	6.8	10x15	0.25	55

Rated Voltage (SurageVoltage) (V)	Cap (μF)	Case size Φ D \times L(mm)	tan δ	Ripple current (mA/rms105 $^{\circ}$ C) (120Hz)
550 (600)	8.2	10x15	0.25	60
		13x16	0.25	70
	10	10x20	0.25	75
		13x16	0.25	80
	12	10x20	0.25	85
		13x16	0.25	90
	15	13x20	0.25	95
	18	13x20	0.25	120
	22	13x25	0.25	140
	33	16x30	0.25	180
	47	16x32	0.25	250
		18x30	0.25	260
	68	18x36	0.25	330
	82	18x40	0.25	380

Jamicon Series : SZ

Teapo Series : SZ Ultra low impedance Series

- Endurance: 105°C 2000 hours
- Recommended Applications : Applicable for switching regulator of computer, especially for high frequency
- Corresponding product to RoHS



■ SPECIFICATIONS

Item	Characteristics													
Category Temperature Range	-40 ~ +105°C													
Rated Voltage Range	6.3 ~ 16VDC													
Rated Capacitance Range	470 ~ 3300 μ F													
Capacitance Tolerance	$\pm 20\%$ (120Hz, 20°C)													
Leakage Current (20°C)	$I=0.03CV$ or $3(\mu A)$ whichever is greater, (After rated voltage applied for 2 minutes) I : Max. leakage current (μA), C : Nominal capacitance (μF), V : Rated voltage (V)													
Dissipation Factor(MAX) ($\tan \delta$) (120Hz, 20°C)	<table border="1"> <tr> <td>WV</td> <td>6.3</td> <td>10</td> <td>16</td> </tr> <tr> <td>$\tan \delta$</td> <td>0.22</td> <td>0.19</td> <td>0.16</td> </tr> </table> <p>When nominal capacitance is over 1000 μF, $\tan \delta$ shall be added 0.02 to the listed value with increase of every 1000 μF.</p>	WV	6.3	10	16	$\tan \delta$	0.22	0.19	0.16					
WV	6.3	10	16											
$\tan \delta$	0.22	0.19	0.16											
Low Temperature Stability Impedance Ratio (MAX)	<table border="1"> <tr> <td rowspan="3">Z(120Hz)</td> <td>WV</td> <td>6.3</td> <td>10</td> <td>16</td> </tr> <tr> <td>Z-25°C / Z+20°C</td> <td>4</td> <td>3</td> <td>2</td> </tr> <tr> <td>Z-40°C / Z+20°C</td> <td>8</td> <td>6</td> <td>4</td> </tr> </table>	Z(120Hz)	WV	6.3	10	16	Z-25°C / Z+20°C	4	3	2	Z-40°C / Z+20°C	8	6	4
Z(120Hz)	WV		6.3	10	16									
	Z-25°C / Z+20°C		4	3	2									
	Z-40°C / Z+20°C	8	6	4										
Endurance	<p>After applying rated voltage with ripple current for 2000 hours at 105°C, the capacitors shall meet the following requirements.</p> <table border="1"> <tr> <td>Capacitance change</td> <td>Within $\pm 25\%$ of initial value</td> </tr> <tr> <td>D.F. ($\tan \delta$)</td> <td>Not more than 200% of specified value</td> </tr> <tr> <td>Leakage current</td> <td>Not more than the specified value</td> </tr> </table>	Capacitance change	Within $\pm 25\%$ of initial value	D.F. ($\tan \delta$)	Not more than 200% of specified value	Leakage current	Not more than the specified value							
Capacitance change	Within $\pm 25\%$ of initial value													
D.F. ($\tan \delta$)	Not more than 200% of specified value													
Leakage current	Not more than the specified value													
Shelf Life	The following specifications shall be satisfied when the capacitors are restored to 20°C after exposing them for 1,000 hours at 105°C without voltage applied. Before the measurement, the capacitor shall be preconditioned by applying voltage according to item 4.1 of JIS C 5101-4.													

■ Dimensions [mm]

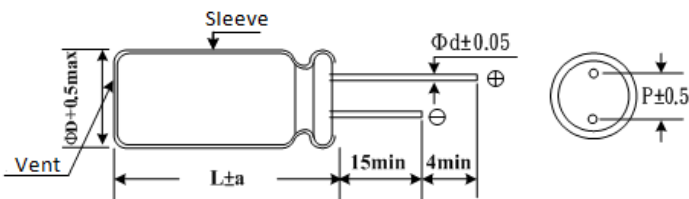

ΦD	8	10	12.5
P	3.5	5	5
Φd	0.6	0.6	0.6
a	1.5	1.5	2.0

■ Multiplier for Ripple Current

Freq. (Hz)	120	1K	10K	100K
Factor	0.5	0.8	0.9	1.0

Jamicon Series : SZ

Teapo Series : SZ

■ STANDARD RATINGS

Rated Voltage (SurageVoltage) (V)	Cap (μ F)	Case size Φ D \times L(mm)	Ripple current (mA/rms105°C) (100KHz)	Impedance (m Ω ,20°C) (100KHz)
6.3V (8)	820	8 x 11	1036	43
	1200	8 x 15	1355	34
	1500	8 x 20	1740	25
		10 x 12.5	1400	31
	1800	10 x 16	1818	23
	2200	10 x 20	2318	15
	3300	10 x 25	2364	14
10V (13)	680	8 x 11	1036	43
	1000	8 x 15	1355	34
		10 x 12.5	1400	31
	1500	8 x 20	1700	25

Rated Voltage (SurageVoltage) (V)	Cap (μ F)	Case size Φ D \times L(mm)	Ripple current (mA/rms105°C) (100KHz)	Impedance (m Ω ,20°C) (100KHz)
10V (13)	1500	10 x 16	1818	23
	1800	10 x 20	2318	16
	2200	10 x 25	2545	14
16V (20)	470	8 x 11	1036	43
	680	8 x 15	1355	34
		10 x 12.5	1400	31
	1000	8 x 20	1700	25
		10 x 16	1818	23
	1500	10 x 20	2318	16
1800	10 x 25	2546	14	

Jamicon Series : MZ

Teapo Series : MZ

Ultra low impedance

- Endurance: 105°C 2000 hours
- Recommended Applications : Applicable for switching regulator of computer, especially for high frequency
- Corresponding product to RoHS



SPECIFICATIONS

Item	Characteristics																				
Category Temperature Range	-40 ~ +105°C																				
Rated Voltage Range	6.3 ~ 25VDC																				
Rated Capacitance Range	470 ~ 4700 μ F																				
Capacitance Tolerance	\pm 20 % (120Hz , 20°C)																				
Leakage Current (20°C)	I=0.03CV or 3(μ A)whichever is greater,(After rated voltage applied for 2 minutes) I : Max. leakage current (μ A), C : Nominal capacitance (μ F), V : Rated voltage (V)																				
Dissipation Factor(MAX) (tan δ) (120Hz ,20°C)	<table border="1"> <tr> <td>WV</td> <td>6.3</td> <td>10</td> <td>16</td> <td>25</td> </tr> <tr> <td>tan δ</td> <td>0.22</td> <td>0.19</td> <td>0.16</td> <td>0.16</td> </tr> </table> <p>When nominal capacitance is over 1000 μF,tan δ shall be added 0.02 to the listed value with increase of every 1000 μF.</p>	WV	6.3	10	16	25	tan δ	0.22	0.19	0.16	0.16										
WV	6.3	10	16	25																	
tan δ	0.22	0.19	0.16	0.16																	
Low Temperature Stability Impedance Ratio (MAX)	<table border="1"> <tr> <td>WV</td> <td>6.3</td> <td>10</td> <td>16</td> <td>25</td> </tr> <tr> <td>Z(120Hz)</td> <td></td> <td></td> <td></td> <td></td> </tr> <tr> <td>Z-25°C / Z+20°C</td> <td>4</td> <td>3</td> <td>2</td> <td>2</td> </tr> <tr> <td>Z-40°C / Z+20°C</td> <td>8</td> <td>6</td> <td>4</td> <td>4</td> </tr> </table>	WV	6.3	10	16	25	Z(120Hz)					Z-25°C / Z+20°C	4	3	2	2	Z-40°C / Z+20°C	8	6	4	4
WV	6.3	10	16	25																	
Z(120Hz)																					
Z-25°C / Z+20°C	4	3	2	2																	
Z-40°C / Z+20°C	8	6	4	4																	
Endurance	After applying rated voltage with ripple current for 2000 hours at 105°C, the capacitors shall meet the following requirements. <table border="1"> <tr> <td>Capacitance change</td> <td>Within \pm 25% of initial value</td> </tr> <tr> <td>D.F. (tan δ)</td> <td>Not more than 200% of specified value</td> </tr> <tr> <td>Leakage current</td> <td>Not more than the specified value</td> </tr> </table>	Capacitance change	Within \pm 25% of initial value	D.F. (tan δ)	Not more than 200% of specified value	Leakage current	Not more than the specified value														
Capacitance change	Within \pm 25% of initial value																				
D.F. (tan δ)	Not more than 200% of specified value																				
Leakage current	Not more than the specified value																				
Shelf Life	The following specifications shall be satisfied when the capacitors are restored to 20°C after exposing them for 1,000 hours at 105°C without voltage applied. Before the measurement, the capacitor shall be preconditioned by applying voltage according to item 4.1 of JIS C 5101-4.																				

Dimensions [mm]

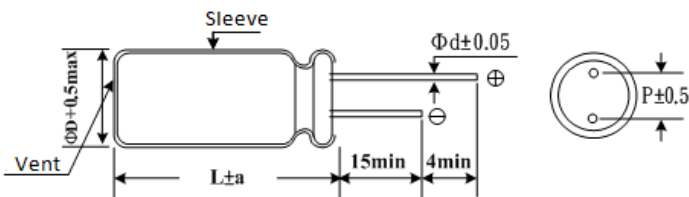

Φ D	8	10	12.5
P	3.5	5.0	5.0
Φ d	0.6	0.6	0.6
a	1.5	1.5	2.0

Multiplier for Ripple Current

Freq. (Hz)	120	1K	10K	100K
Factor	0.5	0.8	0.9	1.0

Jamicon Series : MZ

Teapo Series : MZ

■ STANDARD RATINGS

Rated Voltage (SurageVoltage) (V)	Cap (μ F)	Case size Φ D \times L(mm)	Ripple current (mA/rms105°C) (100KHz)	Impedance (m Ω ,20°C) (100KHz)
6.3V (8)	820	8x11	1230	40
	1000	8x16	1560	31
	1200	8x16	1710	31
	1500	8x20	2040	22
		10x12.5	1760	26
	1800	10x16	2140	20
	2200	10x20	2530	15
	3300	10x23	3110	13
	3900	10x26	3480	13
4700	12.5x26	3810	14	
10V (13)	680	8x14	1230	40
	1000	8x16	1660	31
		10x12.5	1700	29

Rated Voltage (SurageVoltage) (V)	Cap (μ F)	Case size Φ D \times L(mm)	Ripple current (mA/rms105°C) (100KHz)	Impedance (m Ω ,20°C) (100KHz)
10V (13)	1500	8x20	2150	21
		10x16	2200	21
	1800	10x20	2660	14
		10x23	3000	13
16V (20)	470	8x11	1160	40
	680	8x16	1610	31
		10x12.5	1640	29
	1000	8x20	2160	21
		10x16	2210	21
	1500	10x20	2830	14
	1800	10x23	3300	13
25V (33)	470	10x16	2030	29

Jamicon Series : WL

Teapo Series : WL Low impedance

- Endurance: 105°C 1000~2000hours
- Recommended Applications : High quality, high reliability, CV products, dedicated to mobile phone charger.
- Corresponding product to RoHS



■ SPECIFICATIONS

Item	Characteristics																																
Category Temperature Range	-55~+105°C																																
Rated Voltage Range	6.3 ~ 63VDC																																
Rated Capacitance Range	4.7 ~ 10000 μ F																																
Capacitance Tolerance	\pm 20 % (120Hz , 20°C)																																
Leakage Current (20°C)	I=0.01CV or 3 μ A ,whichever is greater. (After rated voltage applied for 3 minutes) I : Max. leakage current (μ A), C : Nominal capacitance (μ F), V : Rated voltage (V)																																
Dissipation Factor(MAX) (tan δ) (120Hz ,20°C)	<table border="1"> <tr> <td>WV</td> <td>6.3</td> <td>10</td> <td>16</td> <td>25</td> <td>35</td> <td>50</td> <td>63</td> </tr> <tr> <td>tan δ</td> <td>0.22</td> <td>0.19</td> <td>0.16</td> <td>0.14</td> <td>0.12</td> <td>0.10</td> <td>0.10</td> </tr> </table>	WV	6.3	10	16	25	35	50	63	tan δ	0.22	0.19	0.16	0.14	0.12	0.10	0.10																
	WV	6.3	10	16	25	35	50	63																									
tan δ	0.22	0.19	0.16	0.14	0.12	0.10	0.10																										
When nominal capacitance is over 1000 μ F,tan δ shall be added 0.02 to the listed value with increase of every 1000 μ																																	
Low Temperature Stability Impedance Ratio (MAX)	<table border="1"> <tr> <td>WV</td> <td>6.3</td> <td>10</td> <td>16</td> <td>25</td> <td>35</td> <td>50</td> <td>63</td> </tr> <tr> <td>Z(120Hz)</td> <td>6.3</td> <td>10</td> <td>16</td> <td>25</td> <td>35</td> <td>50</td> <td>63</td> </tr> <tr> <td>Z-25°C / Z+20°C</td> <td>3</td> <td>3</td> <td>3</td> <td>2</td> <td>2</td> <td>2</td> <td>2</td> </tr> <tr> <td>Z-55°C / Z+20°C</td> <td>6</td> <td>6</td> <td>6</td> <td>4</td> <td>4</td> <td>4</td> <td>4</td> </tr> </table>	WV	6.3	10	16	25	35	50	63	Z(120Hz)	6.3	10	16	25	35	50	63	Z-25°C / Z+20°C	3	3	3	2	2	2	2	Z-55°C / Z+20°C	6	6	6	4	4	4	4
	WV	6.3	10	16	25	35	50	63																									
	Z(120Hz)	6.3	10	16	25	35	50	63																									
Z-25°C / Z+20°C	3	3	3	2	2	2	2																										
Z-55°C / Z+20°C	6	6	6	4	4	4	4																										
After applying rated voltage with rated ripple current for1000 ($\geq 10 \phi 2000$) hours at 105°C, the capacitors shall meet the following requirements.																																	
Endurance	<table border="1"> <tr> <td>Capacitance change</td> <td>Within \pm 20% of initial value</td> <td>DΦ</td> <td>寿命时间</td> </tr> <tr> <td>D.F. (tan δ)</td> <td>Not more than 200% of specified value</td> <td>$\leq 8 \Phi$</td> <td>1000小时</td> </tr> <tr> <td>Leakage current</td> <td>Not more than the specified value</td> <td>$\geq 10 \Phi$</td> <td>2000小时</td> </tr> </table>	Capacitance change	Within \pm 20% of initial value	D Φ	寿命时间	D.F. (tan δ)	Not more than 200% of specified value	$\leq 8 \Phi$	1000小时	Leakage current	Not more than the specified value	$\geq 10 \Phi$	2000小时																				
	Capacitance change	Within \pm 20% of initial value	D Φ	寿命时间																													
	D.F. (tan δ)	Not more than 200% of specified value	$\leq 8 \Phi$	1000小时																													
Leakage current	Not more than the specified value	$\geq 10 \Phi$	2000小时																														
Shelf Life	The following specifications shall be satisfied when the capacitors are restored to 20°C after exposing them for1,000 hours at 105°C without voltage applied. Before the measurement, the capacitor shall be preconditioned by applying voltage according to item 4.1 of JIS C 5101-4.																																

■ Dimensions [mm]

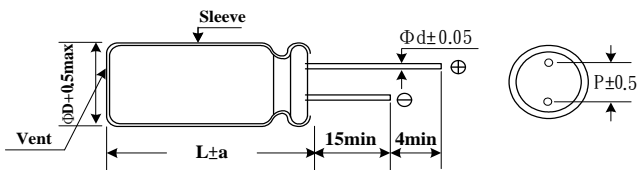

ϕ D	5	6.3	8	10	12.5	16	18
P	2.0	2.5	3.5	5.0	5.0	7.5	7.5
ϕ d	0.5	0.5	0.6	0.6	0.6	0.8	0.8
a	1.5	1.5	1.5	1.5	2.0	2.0	2.0

■ Multiplier for Ripple Current

WV	Fréq. (Hz)	60	120	400	1K	10K	100K
	10 ~ 16V	0.45	0.60	0.83	0.94	0.98	1.00
	25 ~ 35V	0.38	0.50	0.75	0.9	0.97	1.00
	50V	0.36	0.46	0.70	0.88	0.94	1.00

Jamicon Series : WL

Teapo Series : WL

STANDARD RATINGS

Rated Voltage (SurageVoltage) (V)	Cap (μF)	Case size ΦDxL(mm)	Ripple current (mA/rms 105°C) (100KHz)	Impedance (Ω ,20°C) (100KHz)	Impedance (Ω , -10°C) (100KHz)	Rated Voltage (SurageVoltage) (V)	Cap (μF)	Case size ΦDxL(mm)	Ripple current (mA/rms 105°C) (100KHz)	Impedance (Ω ,20°C) (100KHz)	Impedance (Ω , -10°C) (100KHz)	
6.3V (8)	150	5x11	250	0.219	0.656	10V (13)	820	8x15	990	0.076	0.228	
	180	5x11	270	0.190	0.571			10x12.5	1040	0.076	0.228	
	220	5x11	300	0.162	0.487		1000	8x20	1240	0.068	0.204	
	270	5x15	380	0.148	0.444			10x16	1280	0.068	2.024	
		6.3x15	380	0.148	0.444		1200	10x20	1540	0.059	0.177	
	330	5x15	420	0.130	0.389			12.5x15	1480	0.059	0.148	
		6.3x11	420	0.130	0.389		1500	10x25	1830	0.035	0.106	
	390	6.3x15	520	0.117	0.351			12.5x18	1720	0.035	0.089	
		8x11	530	0.117	0.351		1800	10x25	2000	0.031	0.094	
	470	6.3x15	570	0.106	0.319			12.5x18	1880	0.031	0.078	
		8x11	580	0.106	0.319		2200	10x28	2250	0.027	0.082	
	560	6.3x15	620	0.094	0.283			16x15	1960	0.027	0.068	
		8x11	630	0.094	0.283		2700	12.5x20	2250	0.025	0.062	
	680	6.3x15	680	0.084	0.252			16x15	2100	0.025	0.062	
		8x11	700	0.084	0.252		3300	12.5x25	2650	0.023	0.057	
	820	8x15	860	0.077	0.230			18x15	2300	0.023	0.057	
		1000	10x12.5	900	0.077		0.230	3900	12.5x30	3030	0.022	0.055
	8x15		950	0.069	0.206		16x20		2670	0.022	0.055	
	1200	10x12.5	990	0.069	0.206		4700	12.5x35	3210	0.021	0.053	
		1500	8x20	1180	0.059			0.178	16x25	3050	0.021	0.053
	10x16		1210	0.059	0.178		5600	12.5x40	3550	0.020	0.049	
	1800	10x20	1450	0.036	0.107			18x20	2940	0.020	0.049	
		12.5x15	1390	0.036	0.089		6800	16x32	3680	0.019	0.047	
	2200	10x20	1590	0.031	0.094			18x25	3390	0.019	0.047	
		12.5x15	1520	0.031	0.078		8200	16x36	4010	0.018	0.044	
	2700	10x25	1880	0.028	0.083			18x32	3870	0.018	0.044	
		12.5x18	1770	0.028	0.069		10000	18x36	4190	0.017	0.042	
	3300	10x28	2140	0.025	0.075			16V (20)	56	5x11	190	0.253
		3900	16x15	1870	0.025		0.063		68	5x11	210	0.221
	4700		12.5x20	2150	0.023		0.058		82	5x11	230	0.203
5600		16x15	2010	0.023	0.058	100	5x11		250	0.183	0.550	
	6800	12.5x25	2520	0.022	0.055	120	5x15		320	0.156	0.469	
18x15		2190	0.022	0.055	6.3x11		320		0.156	0.469		
8200	12.5x30	2860	0.021	0.053	150	5x15	360		0.128	0.383		
	16x20	2520	0.021	0.053		6.3x11	350		0.128	0.383		
10000	12.5x35	3060	0.020	0.050	180	5x15	390		0.111	0.333		
	16x25	2900	0.020	0.050		6.3x11	390		0.111	0.333		
6.3V (8)	100	5x11	230	0.312	0.937	16V (20)	220		5x15	430	0.095	0.284
	120	5x11	250	0.266	0.798				6.3x11	430	0.095	0.284
150	5x11	280	0.218	0.653	270		6.3x15		550	0.086	0.259	
180	5x15	360	0.189	0.568			8x11		550	0.086	0.259	
	220	6.3x11	350	0.189	0.568		330		6.3x15	600	0.086	0.227
270		5x15	400	0.161	0.484				8x11	610	0.086	0.227
	6.3x11	390	0.161	0.484	390		8x15		750	0.068	0.205	
330	5x15	440	0.147	0.442			10x12.5		790	0.068	0.205	
	6.3x11	430	0.147	0.442	470		8x15		820	0.062	0.186	
390	6.3x15	550	0.129	0.387			10x12.5		860	0.062	0.186	
	470	8x11	560	0.129	0.387		560	8x20	1020	0.055	0.165	
560		6.3x15	600	0.116	0.349			10x16	1050	0.055	0.165	
	8x11	610	0.116	0.349	680		8x20	1120	0.049	0.147		
680	6.3x15	660	0.106	0.317			10x16	1150	0.049	0.147		
	8x11	670	0.106	0.317	820		8x20	1230	0.045	0.134		
820	6.3x15	720	0.094	0.281			10x16	1270	0.045	0.134		
	8x11	730	0.094	0.281	1000		10x20	1540	0.040	0.120		
1000	8x15	900	0.083	0.250			12.5x15	1480	0.040	0.100		
	10x12.5	950	0.083	0.250	1200		10x25	1870	0.035	0.107		
1200	10x25	1870	0.035	0.107			12.5x18	1750	0.035	0.087		
	1500	10x28	2100	0.029	0.088	1500	16x15	1830	0.029	0.074		
16x15		2000	0.026	0.065	1800		12.5x20	2140	0.026	0.065		
1800	16x15	2000	0.026	0.065		16x15	2000	0.026	0.065			
	12.5x25	2500	0.023	0.057	2200	12.5x25	2500	0.023	0.057			

Jamicon Series : WL

Teapo Series : WL

STANDARD RATINGS

Rated Voltage (SurageVoltage) (V)	Cap (μF)	Case size Φ DxL(mm)	Ripple current (mA/rms 105°C) (100KHz)	Impedance (Ω ,20°C) (100KHz)	Impedance (Ω , -10°C) (100KHz)	Rated Voltage (SurageVoltage) (V)	Cap (μF)	Case size Φ DxL(mm)	Ripple current (mA/rms 105°C) (100KHz)	Impedance (Ω ,20°C) (100KHz)	Impedance (Ω , -10°C) (100KHz)	
16V (20)	2200	18x15	2170	0.023	0.057	35V (44)	33	5x11	200	0.353	1.058	
	2700	12.5x30	2890	0.021	0.052		39	5x11	210	0.320	0.096	
		16x20	2540	0.021	0.052		47	5x11	230	0.283	0.849	
	3300	12.5x35	3130	0.019	0.048		56	5x15	290	0.252	0.757	
		16x25	2970	0.019	0.048			6.3x11	290	0.252	0.757	
	3900	12.5x40	3500	0.018	0.046		68	5x15	320	0.220	0.660	
		18x20	2900	0.018	0.046			6.3x11	320	0.220	0.660	
	4700	16x32	3560	0.016	0.040		82	5x15	360	0.203	0.608	
		18x25	3280	0.016	0.040			6.3x11	350	0.203	0.608	
	5600	16x36	3880	0.015	0.038		100	6.3x15	450	0.183	0.549	
18x32		3740	0.015	0.038	8x11			450	0.183	0.549		
25V (32)	47	5x11	220	0.283	0.085		120	6.3x15	490	0.109	0.327	
	56	5x11	240	0.253	0.758			8x11	500	0.109	0.327	
	68	5x11	270	0.020	0.661			150	6.3x15	550	0.089	0.268
	82	5x15	340	0.203	0.609				8x11	550	0.089	0.268
		6.3x11	330	0.203	0.609			180	8x15	680	0.078	0.233
	100	5x15	370	0.183	0.549				10x12.5	720	0.078	0.233
		6.3x11	370	0.183	0.549			220	8x15	750	0.066	0.198
	120	5x15	410	0.156	0.468				10x12.5	790	0.066	0.198
		6.3x11	400	0.156	0.468			270	8x20	950	0.060	0.181
	150	6.3x15	510	0.128	0.383	10x16			970	0.060	0.181	
		8x11	520	0.128	0.383	330		8x20	1050	0.053	0.159	
	180	6.3x15	560	0.111	0.333			10x16	1080	0.053	0.159	
		8x11	570	0.111	0.333	390		10x20	1290	0.048	0.143	
	220	6.3x15	620	0.095	0.284			12.5x15	1240	0.048	0.119	
		8x11	630	0.095	0.284	470		10x20	1420	0.043	0.130	
	270	8x15	790	0.086	0.259			12.5x15	1360	0.043	0.108	
		10x12.5	830	0.086	0.259	560		10x25	1710	0.038	0.115	
	330	8x15	870	0.076	0.227			12.5x18	1610	0.038	0.096	
		10x12.5	910	0.076	0.227	680		10x28	1990	0.034	0.103	
	390	8x20	1080	0.068	0.205			16x15	1730	0.034	0.086	
		10x16	1100	0.068	0.205	820	10x30	2250	0.031	0.094		
	470	8x20	1180	0.062	0.186		16x15	1900	0.031	0.078		
		10x16	1210	0.062	0.186	1000	12.5x25	2480	0.028	0.070		
	560	8x20	1290	0.055	0.165		18x15	2150	0.028	0.070		
		10x16	1320	0.055	0.165	1200	12.5x30	2940	0.024	0.061		
	680	10x20	1610	0.049	0.147		16x20	2590	0.024	0.061		
		12.5x15	1550	0.049	0.122	1500	12.5x35	3160	0.021	0.051		
	820	10x25	1950	0.045	0.134		16x25	3000	0.021	0.051		
		12.5x18	1830	0.045	0.110	1800	12.5x40	3690	0.018	0.045		
	1000	10x28	2270	0.040	0.120		18x20	3050	0.018	0.045		
		16x15	1980	0.040	0.100	2200	16x32	3810	0.016	0.040		
	1200	12.5x20	2320	0.035	0.104		18x25	3510	0.016	0.040		
		16x15	2170	0.035	0.087	50V (63)	4.7	5x11	85	1.061	3.182	
	1500	12.5x25	2710	0.029	0.074		6.8	5x11	100	0.916	2.749	
		18x15	2480	0.029	0.074		10	5x11	130	0.831	2.493	
	1800	12.5x30	3230	0.026	0.065		15	5x11	150	0.609	1.828	
		16x20	2840	0.026	0.065		18	5x11	170	0.531	1.593	
	2200	12.5x35	3470	0.023	0.057		22	5x11	190	0.453	1.360	
		16x25	3290	0.023	0.057		27	5x11	210	0.100	1.200	
	2700	12.5x40	3910	0.021	0.052		33	5x11	230	0.353	1.058	
18x20		3240	0.021	0.052	39		5x15	290	0.320	0.959		
3300	16x32	4100	0.019	0.047			6.3x11	280	0.320	0.959		
	18x25	3770	0.019	0.047	47		5x15	310	0.283	0.849		
3900	16x36	4530	0.018	0.046			6.3x11	310	0.283	0.849		
	18x32	4360	0.018	0.046	56		5x15	340	0.252	0.757		
4700	18x36	4720	0.016	0.040			6.3x11	340	0.252	0.757		
35V (44)	10	5x11	110	0.832	2.495		68	6.3x15	430	0.220	0.660	
	15	5x11	120	0.610	1.829			8x11	430	0.220	0.660	
	18	5x11	150	0.531	1.594		82	6.3x15	470	0.203	0.608	
	22	5x11	160	0.454	1.361			8x11	480	0.203	0.608	
	27	5x11	180	0.400	1.201		100	6.3x15	470	0.203	0.608	
								8x15	590	0.183	0.548	

Jamicon Series : WL

Teapo Series : WL

STANDARD RATINGS

Rated Voltage (SurageVoltage) (V)	Cap (μF)	Case size Φ DxL(mm)	Ripple current (mA/rms 105°C) (100KHz)	Impedance (Ω,20°C) (100KHz)	Impedance (Ω,-10°C) (100KHz)	Rated Voltage (SurageVoltage) (V)	Cap (μF)	Case size Φ DxL(mm)	Ripple current (mA/rms 105°C) (100KHz)	Impedance (Ω,20°C) (100KHz)	Impedance (Ω,-10°C) (100KHz)	
50V (63)	100	10x12.5	620	0.183	0.548	50V (63)	820	12.5x35	2880	0.031	0.078	
	120	8x15	650	0.109	0.327			16x25	2730	0.031	0.078	
		10x12.5	680	0.109	0.327			12.5x40	3390	0.028	0.070	
	150	8x20	820	0.089	0.268			18x20	2800	0.028	0.070	
		10x16	840	0.089	0.268			16x32	3660	0.024	0.061	
	180	8x20	900	0.078	0.233			18x25	3370	0.024	0.061	
		10x16	920	0.078	0.233		16x36	4040	0.021	0.051		
	220	8x20	1000	0.066	0.198		18x32	3890	0.021	0.051		
		10x16	1020	0.066	0.198		63V (79)	10	5x11	130	0.997	2.991
	270	10x20	1250	0.060	0.181			22	5x11	190	0.544	1.632
		12.5x15	1200	0.060	0.151			33	6.3x11	210	0.544	1.632
	330	10x25	1530	0.053	0.159				5x15	260	0.423	1.269
		12.5x18	1430	0.053	0.132	6.3x11		260	0.423	1.269		
	390	10x25	1660	0.048	0.143	47		8x11	360	0.339	1.018	
		12.5x18	1560	0.048	0.119	68		8x15	490	0.220	0.660	
	470	12.5x20	1790	0.043	0.108	100		10x12.5	620	0.183	0.548	
		16x15	1680	0.043	0.108	220		10x20	1130	0.094	0.283	
	560	12.5x25	2150	0.038	0.096	330		10x30	1660	0.076	0.227	
18x15		1870	0.038	0.096	470	12.5x25		1970	0.062	0.155		
680	12.5x30	2580	0.034	0.086	680	12.5x35		2760	0.039	0.098		
	16x20	2260	0.034	0.086	1000	16x25	3020	0.032	0.080			

Jamicon Series : TL

Teapo Series : SJ Low impedance · High Ripple Series

- Endurance: 105°C, 1000~5000 hours
- Recommended Applications : Applying to AV(TV, video, audio), monitor /computer, OA/HA /communication, transducer/inverter, adapter, switching power supply
- Corresponding product to RoHS



SPECIFICATIONS

Item	Characteristics									
Category Temperature Range	-40 ~ +105°C									
Rated Voltage Range	6.3 ~ 100VDC									
Rated Capacitance Range	5.6 ~ 6800 μF									
Capacitance Tolerance	± 20 % (120Hz, 20°C)									
Leakage Current (20°C)	I ≤ 0.01CV or 3 μA, whichever is greater. (After rated voltage applied for 2 minutes) I : Max. leakage current (μA), C : Nominal capacitance (μF), V : Rated voltage (V)									
Dissipation Factor(MAX) (tan δ) (120Hz, 20°C)	WV	6.3	10	16	25	35	50	63	100	
	tan δ	0.22	0.19	0.16	0.14	0.12	0.10	0.09	0.08	
When nominal capacitance is over 1000 μF, tan δ shall be added 0.02 to the listed value with increase of every 1000 μF.										
Low Temperature Stability Impedance Ratio (MAX)	WV	6.3	10	16	25	35	50	63	100	
	Z(120Hz)	6.3	10	16	25	35	50	63	100	
	Z(-25°C) / Z(20°C)	4	3	2	2	2	2	2	2	
	Z(-40°C) / Z(20°C)	8	6	4	3	3	3	3	3	
Endurance	The following specifications shall be satisfied when the capacitors are restored to 20°C after subjected to DC voltage with the rated ripple current is applied (the peak voltage shall not exceed the rated voltage) for the specified period of time at 105°C.								Case size (Φ)	Life time (hours)
									L=7	1000
	Capacitance change								Φ D ≤ 6.3	2000
	D.F. (tan δ)								Φ D = 8	3000
Leakage current								Φ D = 10	5000	
Shelf Life	The following specifications shall be satisfied when the capacitors are restored to 20°C after exposing them for 1,000 hours (L=7mm is 500Hours) at 105°C without voltage applied. Before the measurement, the capacitor shall be preconditioned by applying voltage according to item 4.1 of JIS C 5101-4.									

Dimensions [mm]

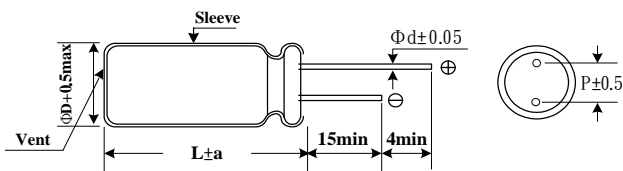

ΦD	4	5	6.3	8	10	13	16	18
P	1.5	2	2.5	3.5	5.0	5.0	7.5	7.5
Φd	0.45	0.5 (0.45)	0.5 (0.45)	0.6 (0.5)	0.6	0.6	0.8	0.8
a	1.0	1.5 (1.0)	1.5 (1.0)	1.5 (1.0)	1.5	2.0	2.0	2.0

() : L = 7

Multiplier for Ripple Current

Freq. (Hz)	60	120	400	1K	10K	100K
6.3~16V	0.45	0.60	0.83	0.94	0.98	1.00
25~35V	0.38	0.50	0.75	0.90	0.97	1.00
50~63V	0.36	0.46	0.70	0.88	0.94	1.00
100V	0.34	0.44	0.65	0.86	0.92	1.00

Jamicon Series : TL

Teapo Series : SJ

■STANDARD RATINGS

Rated Voltage (Surge Voltage) (V)	Cap (μ F)	Case size Φ DxL(mm)	Impedance (Ω ,20°C) (100KHz)	Ripple current (mA/rms105°C) (100KHz)	Rated Voltage (Surge Voltage) (V)	Cap (μ F)	Case size Φ DxL(mm)	Impedance (Ω ,20°C) (100KHz)	Ripple current (mA/rms105°C) (100KHz)
6.3V (8)	39	4x7	0.85	130	16V (20)	18	4x7	0.92	130
	47	5x7	0.7	175		27	5x7	0.61	190
	56	5x7	0.56	190		33	5x7	0.45	210
	68	5x7	0.43	210		39	5x11	0.43	220
	100	5x11	0.30	250		47	5x11	0.36	230
		6.3x7	0.35	240		56	5x11	0.30	250
	120	5x11	0.38	220		68	6.3x7	0.24	300
		6.3x7	0.29	270		100	6.3x11	0.16	370
	150	5x11	0.3	250			8x7	0.18	350
		6.3x7	0.23	300		120	6.3x11	0.13	410
	180	8x7	0.18	350			8x7	0.15	380
	220	6.3x11	0.13	410		150	8x11	0.12	510
	270	6.3x11	0.16	430		180	8x11	0.11	560
	330	8x11	0.13	540		220	8x11	0.10	620
	470	8x11	0.072	760		270	8x11	0.088	690
	560	8x11	0.072	790		330	8x11	0.072	760
	680	8x15	0.062	1000		470	8x15	0.056	1000
	820	8x15	0.056	1045			10x12.5	0.053	1030
	1000	8x20	0.053	1250		560	8x20	0.049	1140
	1200	8x20	0.041	1529			10x16	0.046	1300
		10x20	0.038	1820		680	8x20	0.041	1250
	1500	10x25	0.026	2150			10x16	0.038	1430
	1800	10x25	0.025	2240		820	10x20	0.032	1650
	2200	12.5x20	0.021	2360		1000	10x20	0.023	1820
	2700	13x20	0.022	2540		1200	10x25	0.022	2150
	3300	12.5x25	0.018	2770		1500	13x20	0.021	2360
3900	12.5x30	0.016	3290	1800	13x25	0.02	2510		
4700	12.5x35	0.015	3400	2200	13x25	0.018	2770		
5600	13x35	0.015	3400	2700	13x30	0.016	3290		
	16x25	0.016	3460		16x20	0.018	3140		
6800	16x25	0.016	3620	3300	13x35	0.015	3400		
10V (13)	27	4x7	0.89	130	3900	16x25	0.016	3460	
	33	5x7	0.75	160	25V (32)	15	4x7	0.94	130
	39	5x7	0.64	175		18	5x7	0.69	170
	47	5x7	0.53	190		27	5x7	0.46	210
	56	5x7	0.44	210		33	5x11	0.42	220
	68	6.3x7	0.44	210		39	5x11	0.36	230
	100	6.3x7	0.3	260		47	5x11	0.30	250
	120	6.3x7	0.23	300		56	6.3x7	0.24	300
	150	8x7	0.18	370		68	6.3x11	0.19	340
	180	8x7	0.15	380			8x7	0.22	340
	220	6.3x11	0.13	410		100	6.3x11	0.13	410
	270	8x11	0.12	580			8x7	0.15	440
	330	8x11	0.11	640		120	8x11	0.12	560
	470	8x11	0.072	760		150	8x11	0.105	630
	560	8x15	0.068	1000		180	8x11	0.088	690
		10x12.5	0.064	940		220	8x11	0.072	760
	680	10x12.5	0.053	1030		270	8x15	0.068	900
	820	8x20	0.05	1130			10x12.5	0.065	930
		10x16	0.046	1300		330	10x12.5	0.053	1030
	1000	8x20	0.041	1250		470	8x20	0.041	1250
		10x16	0.038	1430			10x16	0.038	1430
	1200	10x20	0.023	1820		560	10x20	0.032	1650
	1500	10x25	0.022	2150		680	10x20	0.023	1820
	1800	13x20	0.022	2230		820	10x25	0.022	2150
	2200	13x20	0.021	2360		1000	13x20	0.021	2360
	2700	13x25	0.02	2510		1200	13x25	0.02	2510
3300	13x25	0.018	2770	1500		13x25	0.018	2770	
3900	13x30	0.016	3290	1800	13x30	0.016	3290		
	16x20	0.018	3140		16x20	0.018	3140		
4700	13x35	0.015	3400	2200	13x35	0.015	3400		
5600	16x25	0.016	3695	2700	16x25	0.016	3520		

Jamicon Series : TL

Teapo Series : SJ

■ STANDARD RATINGS

Rated Voltage (SurageVoltage) (V)	Cap (μF)	Case size Φ DxL(mm)	Impedance (Ω,20℃) (100KHz)	Ripple current (mA/rms105℃) (100KHz)	Rated Voltage (SurageVoltage) (V)	Cap (μF)	Case size Φ DxL(mm)	Impedance (Ω,20℃) (100KHz)	Ripple current (mA/rms105℃) (100KHz)
35V (44)	10	4x7	0.96	130	63V (79)	39	8x11	0.42	308
	15	5x7	0.57	190		47	8x11	0.35	380
	18	5x7	0.47	210		56	8x11	0.35	420
	27	5x11	0.37	230		68	8x15	0.26	488
	33	5x11	0.30	250			10x12.5	0.24	500
	39	6.3x7	0.25	300		82	8x15	0.22	536
	47	6.3x11	0.15	380			10x12.5	0.20	552
		8x7	0.19	350		100	10x16	0.16	640
	56	6.3x11	0.13	410		120	8x20	0.16	656
		8x7	0.16	380			10x16	0.15	760
	68	8x11	0.12	510		150	10x20	0.13	808
	100	8x11	0.105	620			13x16	0.13	832
	120	8x11	0.088	680		180	10x20	0.11	900
	150	8x11	0.072	760			13x16	0.11	912
	180	8x15	0.068	910		220	10x25	0.099	1080
		10x12.5	0.065	930		270	13x20	0.081	1200
	220	10x12.5	0.053	1030		330	13x25	0.058	1480
	270	8x20	0.041	1250		390	13x30	0.063	1640
	330	10x16	0.038	1430			16x20	0.073	1448
	470	10x20	0.023	1820		470	13x30	0.061	1800
560	10x25	0.022	2150	16x20	0.061		1592		
680	13x20	0.021	2360	560	13x35	0.047	1960		
820	13x25	0.020	2510		16x25	0.043	2190		
1000	13x25	0.018	2770	680	13x40	0.039	2224		
1200	13x30	0.016	3290		18x20	0.051	1960		
	16x20	0.018	3140	820	16x32	0.035	2720		
1500	13x35	0.015	3400		18x25	0.042	2480		
1800	16x25	0.016	3460	1000	16x36	0.028	3170		
50V (63)	5.6	4x7	1		130	18x32	0.034	3100	
	6.8	5x7	0.74	170	16x40	0.026	3270		
	10	5x7	0.5	210	1200	18x36	0.027	3300	
	15	6.3x7	0.38	220		18x40	0.024	3500	
		5x11	0.48	215	100V (125)	10	6.3x11	0.95	170
	22	5x11	0.34	240		15	6.3x 11	0.57	210
		6.3x7	0.26	300		22	8x11	0.44	330
	27	8x7	0.21	340		27	8x11	0.36	360
	33	8x7	0.17	380		33	8x15	0.3	375
	39	6.3x11	0.16	330		39	8x15	0.25	450
	47	6.3x11	0.15	360		47	10x12.5	0.24	450
	56	6.3x11	0.14	390		56	8x20	0.19	570
	68	8x11	0.11	600		68	10x16	0.18	580
	82	8x11	0.09	660		82	10x20	0.13	750
	100	8x11	0.074	730			13x16	0.13	740
	120	8x15	0.061	950		100	10x25	0.12	880
	150	10x12.5	0.061	980		120	13x20	0.094	1050
	180	8x20	0.046	1190		150	13x25	0.085	1100
	220	10x16	0.042	1370		180	13x25	0.071	1200
	270	10x20	0.03	1580		220	13x30	0.063	1410
330	10x25	0.028	1870	16x20			0.071	1300	
390	13x20	0.028	1870	270		13x35	0.052	1560	
470	13x20	0.027	2050			16x25	0.053	1600	
560	13x25	0.023	2410	18x20		0.069	1470		
680	13x30	0.021	2860	330	13x40	0.046	1700		
820	13x35	0.019	2960	390	16x32	0.041	1750		
	16x20	0.023	2730		18x25	0.049	1620		
1000	16x32	0.021	3350	470	16x36	0.033	1890		
63V (79)	15	5x11	1.19		136	18x32	0.039	1780	
	22	6.3x11	0.726	220	560	16x40	0.03	2080	
	27	6.3x11	0.58	192	18x36	0.031	2060		
	33	6.3x11	0.56	300	680	18x40	0.028	2570	

Jamicon Series : SC

Teapo Series : SC

Low impedance · High Ripple Series



■ Endurance: 105°C 2000~3000 hours

■ Recommended Applications : Applicable for switching regulator of computer , especially for high frequency

■ Corresponding product to RoHS

■ SPECIFICATIONS

Item	Characteristics									
Category Temperature Range	-40 ~ +105°C									
Rated Voltage Range	6.3 ~ 100VDC									
Rated Capacitance Range	4.7 ~ 15000 μ F									
Capacitance Tolerance	$\pm 20\%$ (120Hz, 20°C)									
Leakage Current (20°C)	I=0.01CV or 3 μ A whichever is greater. (After rated voltage applied for 2 minutes) I : Max. leakage current (μ A), C : Nominal capacitance (μ F), V : Rated voltage (V)									
Dissipation Factor(MAX) (tan δ) (120Hz, 20°C)	WV	6.3	10	16	25	35	50	63	100	
	tan δ	0.22	0.19	0.16	0.14	0.12	0.10	0.09	0.08	
When nominal capacitance is over 1000 μ F, tan δ shall be added 0.02 to the listed value with increase of every 1000 μ F.										
Low Temperature Stability Impedance Ratio (MAX)	WV	6.3	10	16	25	35	50	63	100	
	Z(120Hz)	4	3	3	3	3	2	2	2	
	Z-25°C / Z+20°C	8	6	4	4	4	4	4	4	
Endurance	After applying rated voltage with ripple current for 1000~3000 hours at 105°C, the capacitors shall meet the following requirements.									
	Capacitance change	Within $\pm 20\%$ of initial value								
	D.F. (tan δ)	Not more than 200% of specified value								
	Leakage current	Not more than the specified value								
Shelf Life	Case size (Φ)	5 x 11 ~ 10 x 12.5			10 x 15higher					
	Life time (hours)	2000			3000					
The following specifications shall be satisfied when the capacitors are restored to 20°C after exposing them for 1,000 hours at 105°C without voltage applied. Before the measurement, the capacitor shall be preconditioned by applying voltage according to item 4.1 of JIS C 5101-4.										

■ Dimensions [mm]

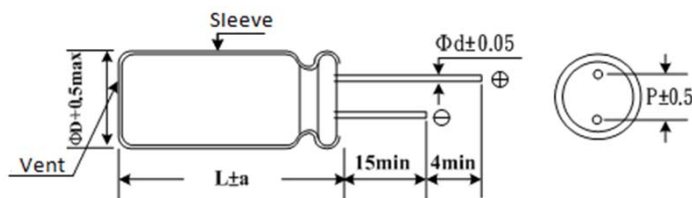

Φ D	5	6.3	8	10	13	16	18	22
P	2.0	2.5	3.5	5.0	5.0	7.5	7.5	10.0
Φ d	0.50	0.5	0.6	0.6	0.6	0.8	0.8	0.8
a	1.5	1.5	1.5	1.5	2.0	2.0	2.0	2.0

■ Multiplier for Ripple Current

Cap (μ F)	Freq. (Hz)					
	50	120	300	1K	10K	100K
$\leq 4.7 \mu$ F	0.30	0.40	0.50	0.70	0.80	1.00
5.6 ~ 33 μ F	0.40	0.50	0.60	0.80	0.90	1.00
34 ~ 330 μ F	0.60	0.70	0.80	0.90	0.95	1.00
331 ~ 1000 μ F	0.65	0.90	0.90	0.98	1.00	1.00
1200 μ F Above	0.85	0.90	0.95	0.98	1.00	1.00

Jamicon Series : SC

Teapo Series : SC

■ STANDARD RATINGS

Rated Voltage (SurageVoltage) (V)	Cap (μF)	Case size Φ DxL(mm)	Ripple current (mA/rms105°C) (100KHz)	Impedance (Ω,20°C) (100KHz)	Rated Voltage (SurageVoltage) (V)	Cap (μF)	Case size Φ DxL(mm)	Ripple current (mA/rms105°C) (100KHz)	Impedance (Ω,20°C) (100KHz)	
6.3V (8)	150	5x11	200	0.420	16V (20)	220	8x11	550	0.140	
	220	6.3x11	250	0.320		330	8x11	550	0.120	
	270	6.3x11	250	0.220			8x15	750	0.100	
	330	6.3x11	250	0.230			10x12.5	688	0.080	
		8x11	400	0.180		470	8x15	730	0.093	
	470	6.3x11	440	0.180			10x12.5	800	0.085	
		8x11	550	0.140		680	10x16	1050	0.064	
	680	8x11	580	0.120		820	10x20	1100	0.044	
		8x15	700	0.100		1000	10x16	1140	0.043	
	820	8x20	750	0.085			10x20	1250	0.039	
		1000	8x11	580		0.150	1200	10x25	1310	0.042
	8x15		700	0.085		13x20		1450	0.038	
	8x20		800	0.069		1500	10x20	1200	0.045	
	10x12.5		690	0.080			13x20	1600	0.034	
	1200	10x16	1000	0.064		2200	10x30	1780	0.032	
		1500	8x15	980			0.085	13x20	1720	0.033
	8x20		800	0.051			13x25	2000	0.028	
	2200	10x16	1070	0.055		3300	13x40	2200	0.026	
		10x20	1250	0.044			16x25	2200	0.024	
		10x20	1220	0.051		4700	16x36	2550	0.019	
		10x25	1310	0.048		6800	18x36	2800	0.019	
	3300	13x20	1450	0.043		25V (32)	10	5x11	50	0.550
		10x25	1400	0.043			47	5x11	150	0.450
		13x25	1700	0.035			56	5x11	150	0.420
3900		13x25	1750	0.032	68		6.3x11	200	0.370	
		13x30	1570	0.033	100		6.3x11	250	0.220	
4700		13x25	1520	0.032	120		8x11	300	0.200	
		16x25	1800	0.028	150		8x11	550	0.140	
6800		16x32	2000	0.024	220		8x11	550	0.120	
		16x32	2350	0.019			8x15	750	0.100	
8200		16x36	2550	0.019	330		8x15	660	0.100	
	18x36	3000	0.019	8x20			800	0.069		
10V (13)	100	5x11	150	0.420	10x16		900	0.086		
	120	5x11	200	0.370	470		8x20	800	0.067	
	150	6.3x11	250	0.320			10x12.5	760	0.086	
	220	6.3x11	300	0.220			10x16	1050	0.064	
	330	8x11	550	0.140	680		10x20	1100	0.039	
		8x11	550	0.120	820		10x20	1250	0.039	
	470	8x15	750	0.100	1000		10x20	1160	0.047	
		8x11	640	0.110			10x25	1310	0.042	
	680	10x12.5	800	0.085	13x20		1450	0.038		
		10x16	1050	0.064	1200		13x25	1600	0.035	
	820	1000	8x20	1080	0.065		1500	13x30	1750	0.032
			10x12.5	930	0.075			16x25	2000	0.028
		10x16	990	0.085	2200		13x30	1810	0.029	
		10x20	1100	0.050		16x25	1660	0.032		
	1200	10x20	1250	0.044	16x32	2200	0.024			
	1500	10x20	1450	0.039	3300	16x36	2540	0.019		
10x20		1330	0.047	18x36		2550	0.019			
2200	10x25	1450	0.039	4700	18x36	2800	0.019			
		13x20	1600	0.038	6800	18x36	2800	0.019		
	10x30	1740	0.032	35V (44)	4.7	5x11	115	1.200		
	13x25	2000	0.028		6.8	5x11	120	1.000		
4700	13x25	1860	0.028		10	5x11	140	0.900		
	16x25	2200	0.024		15	5x11	170	0.690		
6800	16x36	2550	0.019		22	5x11	190	0.600		
	18x36	2800	0.019		33	5x11	200	0.580		
16V (20)	56	5x11	100		0.630	47	6.3x11	250	0.390	
	68	5x11	150		0.420	68	6.3x11	300	0.220	
	100	5x11	200		0.370	100	6.3x11	350	0.180	
	120	6.3x11	250		0.320		8x11	450	0.140	
	150	6.3x11	300		0.220	120	8x11	550	0.130	

Jamicon Series : SC

Teapo Series : SC

■ STANDARD RATINGS

Rated Voltage (SurageVoltage) (V)	Cap (μ F)	Case size Φ D \times L(mm)	Ripple current (mA/rms105°C) (100KHz)	Impedance (Ω ,20°C) (100KHz)	Rated Voltage (SurageVoltage) (V)	Cap (μ F)	Case size Φ D \times L(mm)	Ripple current (mA/rms105°C) (100KHz)	Impedance (Ω ,20°C) (100KHz)
35V (44)	150	8x15	650	0.100	50V (63)	1000	16x25	1900	0.039
	220	8x15	650	0.100		1200	16x32	2100	0.025
		10x12.5	800	0.069		1500	16x36	2550	0.025
		10x16	900	0.052		2200	18x40	2800	0.025
	330	10x20	1050	0.044	63V (79)	10	5x11	140	1.850
	470	10x20	1300	0.039		15	5x11	200	1.700
	680	13x20	1400	0.038		22	6.3x11	250	1.200
	820	13x20	1550	0.034		33	6.3x11	300	0.900
	1000	13x25	1700	0.029		47	8x11	450	0.700
	1200	16x25	1900	0.028		68	8x11	550	0.520
	1500	16x25	2100	0.024		100	8x20	650	0.350
	2200	16x32	2300	0.021		120	10x16	800	0.300
		16x36	2550	0.019		150	10x16	1050	0.200
18x36		2880	0.019	220		10x20	1300	0.150	
50V (63)	4.7	5x11	115	2.000		330	13x20	1400	0.100
	6.8	5x11	120	1.850		470	13x25	1550	0.064
	10	5x11	140	1.700		680	16x25	1700	0.052
	15	5x11	180	1.200		820	16x32	1900	0.048
	22	5x11	200	0.700		1000	16x32	2100	0.042
	33	6.3x11	250	0.600	1200	16x36	2550	0.036	
	47	6.3x11	300	0.520	1500	18x36	2800	0.033	
	68	8x11	450	0.350	100V (125)	10	6.3x11	200	1.500
	100	8x11	450	0.290		15	6.3x11	250	1.200
		8x15	550	0.250		22	8x11	300	0.790
		120	8x20	650		0.210	33	8x15	450
	150	10x12.5	800	0.160		47	10x16	550	0.350
	220	10x16	1050	0.100		68	10x20	650	0.240
		10x25	1050	0.068		100	13x20	800	0.180
	330	10x20	1300	0.072		120	13x25	1050	0.150
	470	10x20	1390	0.075		150	13x25	1300	0.110
		13x20	1400	0.060		220	16x25	1400	0.071
	680	13x25	1550	0.050		330	16x32	1550	0.049
820	16x25	1700	0.040	470		18x36	1770	0.038	

Jamicon Series : WG

Teapo Series : WG Low impedance Series



■ Endurance: 105°C 2000~3000hrs

■ Recommended Applications : Apply to the requirement of long life, low impedance, high reliability, etc.

■ Corresponding product to RoHS

SPECIFICATIONS

Item	Characteristics									
Category Temperature Range	-55~ +105°C									
Rated Voltage Range	10 ~ 100VDC									
Rated Capacitance Range	47~4700 μ F									
Capacitance Tolerance	$\pm 20\%$ (120Hz, 20°C)									
Leakage Current (20°C)	I \leq 0.01CV (After rated voltage applied for 3 minutes) I : Max. leakage current (μ A), C : Nominal capacitance (μ F), V : Rated voltage (V)									
Dissipation Factor(MAX) (tan δ) (120Hz, 20°C)	WV	10	16	25	35	50	63	100		
	tan δ	0.12	0.1	0.09	0.08	0.07	0.06	0.06		
Low Temperature Stability Impedance Ratio (MAX)	Z(120Hz)	WV								
		10~16	25~100							
		Z-25°C / Z+20°C	3	2						
		Z-55°C / Z+20°C	6	4						
Endurance	After applying rated voltage with rated ripple current for 2000 ($\geq 10 \phi 3000$) hours at 105°C, the capacitors shall meet the following requirements.									
	Capacitance change	Within $\pm 20\%$ of initial value								
	D.F. (tan δ)	Not more than 200% of specified value								
	Leakage current	initial specified value or less								
Shelf Life	The following specifications shall be satisfied when the capacitors are restored to 20°C after exposing them for 1,000 hours at 105°C without voltage applied. Before the measurement, the capacitor shall be preconditioned by applying voltage according to item 4.1 of JIS C 5101-4.									
	Capacitance change	Within $\pm 20\%$ of initial value								
	D.F. (tan δ)	Not more than 200% of specified value								
	Leakage current	Not more than the specified value								

Dimensions [mm]

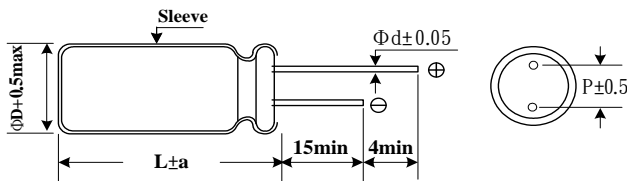

Vent only for 8 Φ

Φ D	8	10	12.5	16	18
P	3.5	5.0	5.0	7.5	7.5
Φ d	0.6	0.6	0.6	0.8	0.8
a	1.5	1.5	2.0	2.0	2.0

Multiplier for Ripple Current

Freq. (Hz)	60	120	400	1K	10K	100K
10~16V	0.45	0.60	0.83	0.94	0.98	1.00
26~35V	0.38	0.50	0.75	0.90	0.97	1.00
50~100V	0.36	0.46	0.70	0.88	0.94	1.00

Jamicon Series : WG

Teapo Series : WG

■ STANDARD RATINGS

Rated Voltage (SurageVoltage) (V)	Cap (μ F)	Case size Φ DxL(mm)	Ripple current (A/rms105°C) (100KHz)	Impedance (Ω ,20°C) (100KHz)	Rated Voltage (SurageVoltage) (V)	Cap (μ F)	Case size Φ DxL(mm)	Ripple current (A/rms105°C) (100KHz)	Impedance (Ω ,20°C) (100KHz)
10V (13)	220	8x11	0.36	0.19	35V (44)	220	10x18	0.66	0.161
	330	8x15	0.50	0.152		330	10x25	0.93	0.129
	470	10x16	0.62	0.124		470	12.5x20	1.07	0.105
	680	10x18	0.78	0.098		680	12.5x25	1.42	0.083
	1000	10x20	1.00	0.080		1000	12.5x30	1.87	0.068
	2200	12.5x25	1.61	0.046		2200	16x40	2.83	0.039
	3300	12.5x30	2.00	0.038		50V (63)	47	8x11	0.29
4700	12.5x40	2.50	0.032	68	8x15		0.39	0.352	
16V (20)	100	8x11	0.27	0.348	100		10x16	0.49	0.292
	220	8x15	0.44	0.180	220		10x20	0.80	0.151
	330	10x16	0.57	0.144	330		12.5x20	1.04	0.121
	470	10x18	0.71	0.118	470		12.5x25	1.37	0.099
	680	10x20	0.90	0.093	680		12.5x30	1.79	0.078
	1000	12.5x20	1.16	0.076	1000	12.5x40	2.48	0.064	
	2200	12.5x30	1.89	0.043	63V (79)	47	8x15	0.35	0.424
3300	12.5x40	2.44	0.036	68		10x16	0.43	0.330	
4700	16x40	2.64	0.031	100		10x18	0.55	0.274	
25V (32)	100	8x11	0.34	0.330		220	12.5x20	0.92	0.142
	220	10x16	0.59	0.170		330	12.5x25	1.24	0.113
	330	10x18	0.76	0.136		470	12.5x30	1.61	0.093
	470	10x20	0.95	0.112		680	16x36	2.09	0.073
	680	12.5x20	1.21	0.088	100V (125)	47	12x25	0.44	0.368
	1000	12.5x25	1.62	0.072		68	12.5x20	0.51	0.286
	2200	12.5x40	2.70	0.041		100	12.5x25	0.68	0.238
3300	16x40	3.04	0.034	220		16x36	1.19	0.123	
35V (44)	68	8x11	0.30	0.374		330	18x40	1.64	0.098
	100	8x15	0.40	0.311					

Jamicon Series : TE

Teapo Series : SY Low impedance · Long life Series

- Features: Low Impedance , high permissible ripple current at high frequency and long life than SC
- Recommended Applications :Used switching regulator applications in computers.
Especially for high frequency.
- Corresponding product to RoHS



SPECIFICATIONS

Item	Characteristics	
Category Temperature Range	-40 ~ +105°C	
Rated Voltage Range	6.3 ~ 100VDC	
Rated Capacitance Range	10 ~ 15000 μ F	
Capacitance Tolerance	$\pm 20\%$ (120Hz , 20°C)	
Leakage Current (20°C)	I=0.01CV or 3 μ A whichever is greater. (After rated voltage applied for 2 minutes) I : Max. leakage current (μ A), C : Nominal capacitance (μ F), V : Rated voltage (V)	
Dissipation Factor(MAX) (tan δ) (120Hz , 20°C)	WV	6.3 10 16 25 35 50 63 100
	tan δ	0.22 0.19 0.16 0.14 0.12 0.10 0.09 0.08
When nominal capacitance is over 1000 μ F, tan δ shall be added 0.02 to the listed value with increase of every 1000 μ F.		
Low Temperature Stability Impedance Ratio (MAX)	Z(120Hz)	6.3 10 16 25 35 50 63 100
	Z-25°C / Z+20°C	4 3 2 2 2 2 2 2
	Z-40°C / Z+20°C	8 6 4 3 3 3 3 3
Endurance	After applying rated voltage with rated ripple current for 3000~ 6000 hours at 105°C, the capacitors shall meet the following requirements.	
	Capacitance change	Within $\pm 25\%$ of initial value
	D.F. (tan δ)	Not more than 200% of specified value
	Leakage current	Not more than the specified value
	D Φ	5~6.3 Φ 8~10 Φ x12.5 10x15~12 Φ 12.5~18 Φ
	life(hours)	3000 hrs 4000 hrs 5000 hrs 6000 hrs
Shelf Life	The following specifications shall be satisfied when the capacitors are restored to 20°C after exposing them for 1,000 hours at 105°C without voltage applied. Before the measurement, the capacitor shall be preconditioned by applying voltage according to item 4.1 of JIS C 5101-4.	

Dimensions [mm]

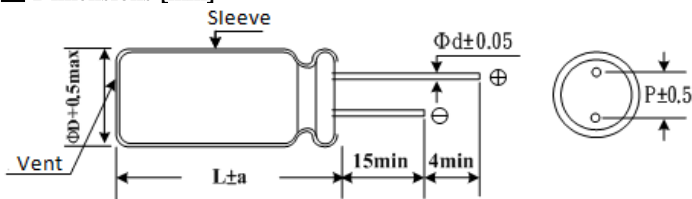

Φ D	5	6.3	8	10	13	16	18
P	2.0	2.5	3.5	5.0	5.0	7.5	7.5
Φ d	0.5	0.5	0.6	0.6	0.6	0.8	0.8
a	1.5	1.5	1.5	1.5	2.0	2.0	2.0

Multiplier for Ripple Current

Freq. (Hz)	120	1 K	10 K	100 K
10~ 180 μ F	0.40	0.75	0.90	1.00
220 ~ 560 μ F	0.50	0.85	0.94	1.00
680 ~ 1800 μ F	0.60	0.87	0.95	1.00
2200 ~ 3900 μ F	0.75	0.90	0.95	1.00
≥ 4700 μ F	0.85	0.95	0.98	1.00

Jamicon Series : TE

Teapo Series : SY

■ STANDARD RATINGS

Rated Voltage (Surage Voltage) (V)	Cap (μF)	Case size Φ DxL(mm)	Ripple current (mA/rms105°C) (100KHz)	Impedance (Ω,20°C) (100KHz)	Rated Voltage (Surage Voltage) (V)	Cap (μF)	Case size Φ DxL(mm)	Ripple current (mA/rms105°C) (100KHz)	Impedance (Ω,20°C) (100KHz)
6.3V (8)	150	5x11	210	0.580	16V(20)	120	6.3x11	340	0.220
	330	6.3x11	340	0.220		220	6.3x11	469	0.185
	470	6.3x11	510	0.160			8x11	582	0.150
	680	8x11	640	0.130		330	8x11	640	0.130
	820	10x12.5	865	0.080		470	*8x15	840	0.087
	1000	8x15	840	0.087			8x20	950	0.078
	1200	8x20	1050	0.069			*10x12.5	865	0.080
		10x16	1210	0.060		10x16	1210	0.060	
	1500	8x20	1050	0.069		680	8x20	1050	0.069
		*10x16	1210	0.060			10x16	1210	0.060
		10x20	1400	0.046		1000	8x20	1050	0.069
	1800	13x16	1450	0.049			*10x16	1210	0.060
	2200	*10x20	1400	0.046			10x20	1400	0.046
		10x25	1650	0.042		13x16	1450	0.049	
	2700	10x30	1910	0.031		1200	10x25	1650	0.042
		16x16	1940	0.042			10x30	1910	0.031
	3300	10x25	1650	0.042		1500	13x20	1900	0.035
		13x20	1900	0.035			16x16	1940	0.042
	3900	13x25	2230	0.027			2200	13x25	2230
		18x16	2210	0.043			18x16	2210	0.043
4700	13x30	2650	0.024	2700	13x30	2650	0.024		
5600	13x35	2880	0.020		16x20	2530	0.027		
	16x20	2530	0.027	3300	13x35	2880	0.020		
6800	13x40	3350	0.017		13x40	3350	0.017		
	16x25	2930	0.021	3900	16x25	2930	0.021		
	18x20	2860	0.026		18x20	2860	0.026		
8200	16x32	3450	0.017		4700	16x32	3450	0.017	
10000	16x36	3610	0.015	18x25		3140	0.019		
	18x25	3140	0.017	5600	16x36	3610	0.015		
12000	18x32	4170	0.015		18x32	4170	0.015		
15000	18x36	4220	0.014	6800	16x40	4080	0.013		
10V (13)	100	5x11	210	0.580	8200	18x36	4220	0.014	
	220	6.3x11	340	0.220	10000	18x40	4280	0.012	
	470	8x11	640	0.130	25V (32)	47	5x11	210	0.580
	680	8x15	840	0.087		100	6.3x11	340	0.220
	820	10x12.5	865	0.080		150	8x11	640	0.160
	1000	8x20	1050	0.069		220	8x11	640	0.130
		10x16	1210	0.060		330	8x15	840	0.087
	1200	10x20	1400	0.046			10x12.5	865	0.080
		10x25	1650	0.042		470	8x20	1050	0.069
	1500	13x16	1450	0.049			*10x12.5	1050	0.070
		10x30	1910	0.031		10x16	1210	0.060	
	2200	13x20	1900	0.042		680	10x20	1400	0.046
		16x16	1940	0.042		820	13x16	1450	0.049
	2700	18x16	2210	0.043			10x25	1650	0.042
		3300	10x30	1910		0.031	1000	10x30	1910
	13x25		2230	0.027		13x20		1900	0.035
	3900	13x30	2650	0.024		16x16		1940	0.042
		16x20	2530	0.027		1200	18x16	2210	0.043
	4700	13x35	2880	0.020		1500	*13x20	1900	0.035
	5600	13x40	3350	0.017			13x25	2230	0.027
16x25		2930	0.021	1800		13x30	2650	0.024	
18x20		2860	0.026			16x20	2530	0.027	
6800	16x32	3450	0.017	2200	13x35	2880	0.020		
	18x25	3140	0.019		18x20	2860	0.026		
8200	16x36	3610	0.015	2700	13x40	3350	0.017		
	18x32	4170	0.015		16x25	2930	0.021		
10000	16x40	4080	0.013	3300	16x32	3450	0.017		
	18x36	4220	0.014		18x25	3140	0.019		
12000	18x40	4280	0.012	3900	18x32	4170	0.015		
16V (20)	100	5x11	210	0.580	4700	18x36	4220	0.014	
		6.3x11	250	0.230	5600	18x40	4280	0.012	

Jamicon Series : TE

Teapo Series : SY

■ STANDARD RATINGS

Rated Voltage (Surage Voltage) (V)	Cap (μF)	Case size Φ DxL(mm)	Ripple current (mA/rms105°C) (100KHz)	Impedance (Ω,20°C) (100KHz)	Rated Voltage (Surage Voltage) (V)	Cap (μF)	Case size Φ DxL(mm)	Ripple current (mA/rms105°C) (100KHz)	Impedance (Ω,20°C) (100KHz)
35V (44)	33	5x11	210	0.580	50V (63)	1200	18x25	2740	0.026
	47	6.3x11	275	0.390		1500	16x36	3150	0.019
	56	6.3x11	340	0.220		1800	16x40	3710	0.016
	68	6.3x11	500	0.170			18x32	3635	0.021
	82	6.3x11	540	0.160		2200	18x36	3680	0.017
	100	8x11	580	0.150		2700	18x40	3800	0.014
	150	8x11	640	0.130	63V (79)	15	5x11	55	2.3
	220	*8x15	840	0.087		33	6.3x11	115	1.2
		10x12.5	865	0.080		56	8x12	232	0.63
	270	8x20	1050	0.069		82	8x15	300	0.45
		*10x16	1210	0.060			10x12.5	288	0.43
	330	10x20	1400	0.046		120	8x20	362	0.33
		10x20	1400	0.046			10x16	357	0.31
	470	13x16	1450	0.049		180	10x20	466	0.21
		10x25	1650	0.042			13x16	466	0.23
	680	10x30	1910	0.031		220	10x25	531	0.2
		13x20	1900	0.035		270	10x30	663	0.15
		16x16	1940	0.042			13x20	690	0.16
	820	13x20	1900	0.035			16x16	795	0.14
	1000	13x25	2230	0.027		330	13x25	784	0.12
		18x16	2210	0.043		390	18x16	920	0.12
	1200	13x30	2650	0.024		470	13x30	905	0.1
		16x20	2530	0.027			16x20	1040	0.091
	1500	13x35	2880	0.020		560	13x35	1050	0.083
13x40		3350	0.017	16x25	1250		0.073		
1800	16x25	2930	0.021	680	13x40	1180	0.071		
	18x20	2860	0.026		18x20	1240	0.08		
2200	16x32	3450	0.017	820	16x32	1570	0.054		
	18x25	3140	0.019		18x25	1490	0.057		
2700	16x36	3610	0.015	1000	16x36	1790	0.045		
	18x32	4170	0.015		18x32	1630	0.047		
3300	16x40	4080	0.013	1200	16x40	2020	0.04		
	18x36	4220	0.014	100V (125)	22	6.3x11	200	0.85	
3900	18x40	4280	0.012		27	8x12	232	0.63	
50V (63)	10	5x11	135		1.200	39	8x15	300	0.45
	22	5x11	180		0.700	47	10x12.5	288	0.43
	33	6.3x11	245		0.490	56	8x20	362	0.33
	47	6.3x11	300		0.520	68	10x16	357	0.31
	56	6.3x11	320		0.300	82	10x20	466	0.21
	100	8x11	555		0.170		13x16	466	0.23
	120	8x15	730		0.120	100	10x25	531	0.2
	150	10x12.5	760		0.120	120	10x30	663	0.15
	180	8x20	910		0.091		13x20	690	0.16
	220	10x16	1050		0.084	150	16x16	795	0.14
	270	10x20	1220		0.060	180	13x25	784	0.12
		13x16	1260		0.061		18x16	920	0.12
	330	*10x20	1400		0.058	220	13x30	905	0.1
		10x25	1440		0.055		16x20	1040	0.091
	470	10x30	1690		0.043	270	13x35	1050	0.083
		13x20	1660		0.045		16x25	1250	0.073
		16x16	1690	0.055	330	13x40	1180	0.071	
	560	13x25	1950	0.034		18x20	1240	0.08	
18x16		1930	0.054	390	16x32	1570	0.054		
680	13x30	2310	0.030		18x25	1490	0.057		
	820	13x35	2510	0.025	470	16x36	1790	0.045	
16x20		2210	0.034	18x32		1630	0.047		
1000	13x40	2920	0.021	560	16x40	2020	0.04		
	16x25	2555	0.025	680	18x36	2020	0.04		
	18x20	2490	0.036	820	18x40	2330	0.036		
1200	16x32	3010	0.022						

Jamicon Series : TT

Teapo Series : TA Low impedance · Long life Series

- Endurance:105°C 4000~10000hours
- Recommended Applications : Applicable for SMPS, Adaptor,Charger,Monitor/Computer
- Corresponding product to RoHS



SPECIFICATIONS

Item	Characteristics																																				
Category Temperature Range	-40 ~ +105°C																																				
Rated Voltage Range	6.3~100VDC																																				
Rated Capacitance Range	22 ~ 8200 μF																																				
Capacitance Tolerance	± 20 % (120Hz , 20°C)																																				
Leakage Current (20°C)	I=0.01CV or 3 μ A whichever is greater. (After rated voltage applied for 2 minutes) I : Max. leakage current (μ A), C : Nominal capacitance (μ F), V : Rated voltage (V)																																				
Dissipation Factor(MAX) (tan δ) (120Hz ,20°C)	<table border="1"> <tr> <td>WV</td> <td>6.3</td> <td>10</td> <td>16</td> <td>25</td> <td>35</td> <td>50</td> <td>63</td> <td>100</td> </tr> <tr> <td>tan δ</td> <td>0.22</td> <td>0.19</td> <td>0.16</td> <td>0.14</td> <td>0.12</td> <td>0.10</td> <td>0.09</td> <td>0.08</td> </tr> </table> <p>When nominal capacitance is over 1000 μ F,tan δ shall be added 0.02 to the listed value with increase of every 1000 μ F.</p>	WV	6.3	10	16	25	35	50	63	100	tan δ	0.22	0.19	0.16	0.14	0.12	0.10	0.09	0.08																		
WV	6.3	10	16	25	35	50	63	100																													
tan δ	0.22	0.19	0.16	0.14	0.12	0.10	0.09	0.08																													
Low Temperature Stability Impedance Ratio (MAX)	<table border="1"> <tr> <td>WV</td> <td>6.3</td> <td>10</td> <td>16</td> <td>25</td> <td>35</td> <td>50</td> <td>63</td> <td>100</td> </tr> <tr> <td>Z((120HZ)</td> <td></td> <td></td> <td></td> <td></td> <td></td> <td></td> <td></td> <td></td> </tr> <tr> <td>Z-25°C / Z+20°C</td> <td>4</td> <td>3</td> <td>2</td> <td>2</td> <td>2</td> <td>2</td> <td>2</td> <td>2</td> </tr> <tr> <td>Z-40°C / Z+20°C</td> <td>8</td> <td>6</td> <td>4</td> <td>3</td> <td>3</td> <td>3</td> <td>3</td> <td>3</td> </tr> </table>	WV	6.3	10	16	25	35	50	63	100	Z((120HZ)									Z-25°C / Z+20°C	4	3	2	2	2	2	2	2	Z-40°C / Z+20°C	8	6	4	3	3	3	3	3
WV	6.3	10	16	25	35	50	63	100																													
Z((120HZ)																																					
Z-25°C / Z+20°C	4	3	2	2	2	2	2	2																													
Z-40°C / Z+20°C	8	6	4	3	3	3	3	3																													
Endurance	<p>After applying rated voltage with rated ripple current for 4000~10000hours at 105°C, the capacitors shall meet the following requirements.</p> <table border="1"> <tr> <td>Capacitance change</td> <td colspan="3">Within ± 25% of initial value</td> </tr> <tr> <td>D.F. (tan δ)</td> <td colspan="3">Not more than 200% of specified value</td> </tr> <tr> <td>Leakage current</td> <td colspan="3">initial specified value or less</td> </tr> </table> <table border="1"> <tr> <td>ΦD</td> <td>5~6.3 Φ</td> <td>8~10 Φ</td> <td>12.5~18 Φ</td> </tr> <tr> <td>6.3~10(V)</td> <td>4000hrs</td> <td>6000hrs</td> <td>8000hrs</td> </tr> <tr> <td>16~100(V)</td> <td>5000hrs</td> <td>7000hrs</td> <td>10000hrs</td> </tr> </table>	Capacitance change	Within ± 25% of initial value			D.F. (tan δ)	Not more than 200% of specified value			Leakage current	initial specified value or less			ΦD	5~6.3 Φ	8~10 Φ	12.5~18 Φ	6.3~10(V)	4000hrs	6000hrs	8000hrs	16~100(V)	5000hrs	7000hrs	10000hrs												
Capacitance change	Within ± 25% of initial value																																				
D.F. (tan δ)	Not more than 200% of specified value																																				
Leakage current	initial specified value or less																																				
ΦD	5~6.3 Φ	8~10 Φ	12.5~18 Φ																																		
6.3~10(V)	4000hrs	6000hrs	8000hrs																																		
16~100(V)	5000hrs	7000hrs	10000hrs																																		
Shelf Life	The following specifications shall be satisfied when the capacitors are restored to 20°C after exposing them for1,000 hours at 105°C without voltage applied. Before the measurement, the capacitor shall be preconditioned by applying voltage according to item 4.1 of JIS C 5101-4.																																				

Dimensions [mm]

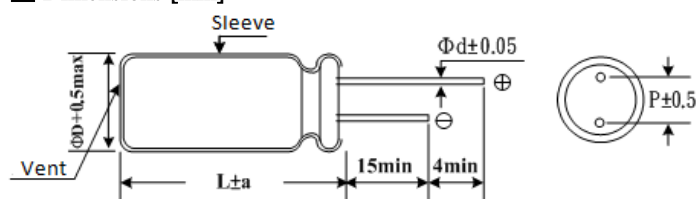

ΦD	5	6.3	8	10	13	16	18
P	2.0	2.5	3.5	5.0	5.0	7.5	7.5
Φd	0.5	0.5	0.6	0.6	0.6	0.8	0.8
a	1.5	1.5	1.5	1.5	2.0	2.0	2.0

Multiplier for Ripple Current

Freq. (Hz)	120	1K	10K	100K
22 ~ 180	0.40	0.75	0.90	1.00
220 ~ 560	0.50	0.85	0.94	1.00
680 ~ 1800	0.60	0.87	0.95	1.00
2200 ~ 3900	0.75	0.90	0.95	1.00
4700 μ F Higher	0.85	0.95	0.98	1.00

Jamicon Series : TT

Teapo Series : TA

■ STANDARD RATINGS

Rated Voltage (SurageVoltage) (V)	Cap (μ F)	Case size Φ DxL(mm)	Ripple current (mA/rms105°C) (100KHz)	Impedance (Ω ,20°C) (100KHz)	Rated Voltage (SurageVoltage) (V)	Cap (μ F)	Case size Φ DxL(mm)	Ripple current (mA/rms105°C) (100KHz)	Impedance (Ω ,20°C) (100KHz)	
6.3V (8)	150	5x11	210	0.580	16V (20)	2700	16x20	2530	0.027	
	330	6.3x11	340	0.220		3300	13x35	2880	0.020	
	680	8x11	640	0.130		3900	13x40	3350	0.017	
	820	10x12.5	865	0.080			16x25	2930	0.021	
	1000	8x15	840	0.087			18x20	2860	0.026	
	1200	8x20	1050	0.069		4700	16x32	3450	0.017	
		10x15	1210	0.060			18x25	3140	0.019	
	1500	10x20	1400	0.046		5600	16x36	3610	0.015	
	1800	13x16	1450	0.049			18x32	4170	0.015	
	2200	10x25	1650	0.042		6800	16x40	4080	0.013	
	2700	10x30	1910	0.031		8200	18x36	4220	0.014	
	3300	13x20	1900	0.035		25V (32)	47	5x11	210	0.580
	3900	13x25	2230	0.027			100	6.3x11	340	0.220
	4700	13x30	2650	0.024			220	6.3x12	400	0.220
	5600	13x35	2880	0.020				8x11	640	0.130
		16x20	2530	0.027			330	8x15	840	0.087
6800	13x40	3350	0.017	10x12.5	865			0.080		
	16x25	2930	0.021	470	8x20		1050	0.069		
	18x20	2860	0.026		10x12.5		865	0.080		
8200	16x32	3450	0.017	10x15	1210		0.060			
10V (13)	100	5x11	210	0.580	35V (44)		33	5x11	210	0.580
	220	6.3x11	340	0.220			56	6.3x11	340	0.220
	470	6.3x12	450	0.220			100	6.3x11	340	0.220
		8x11	640	0.130				8x11	580	0.150
	680	8x15	840	0.087			150	8x11	640	0.130
		10x12.5	865	0.080				220	8x12	640
	1000	8x16	840	0.087			270		8x15	840
		10x12.5	865	0.080		10x12.5		865	0.080	
		8x20	1050	0.069		330	8x20	1050	0.069	
	10x15	1210	0.060	470			10x15	1210	0.060	
	1200	10x20	1400			0.046	10x16	1210	0.060	
	1500	10x25	1650	0.042		560	10x20	1400	0.046	
		13x16	1450	0.049			13x16	1450	0.049	
	2200	10x30	1910	0.031		680	10x25	1650	0.042	
		13x20	1900	0.035			1000	10x30	1910	0.031
	3300	13x25	2230	0.027		1200		13x20	1900	0.035
13x30		2650	0.024	1500	13x25		2230	0.027		
3900	16x20	2530	0.027		2200	13x30	2650	0.024		
	13x35	2880	0.020	16x20		2530	0.027			
5600	13x40	3350	0.017	2700	13x35	2880	0.020			
	16x25	2930	0.021		1800	13x40	3350	0.017		
6800	18x20	2860	0.026							
	16x32	3450	0.017							
8200	18x25	3140	0.019							
	16x36	3610	0.015							
	18x32	4170	0.015							
16V (20)	56	5x11	210	0.580						
	100	5x11	210	0.580						
	120	6.3x11	340	0.220						
	220	6.3x11	340	0.220						
	330	8x11	640	0.130						
	470	8x15	840	0.087						
		10x12.5	865	0.080						
	680	8x20	1050	0.069						
		10x15	1210	0.060						
	1000	10x20	1400	0.046						
		13x16	1450	0.049						
	1200	10x25	1650	0.042						
1500	10x30	1910	0.031							
	13x20	1900	0.035							
2200	13x20	1900	0.035							
	13x25	2230	0.027							
2700	13x30	2650	0.024							

Jamicon Series : TT

Teapo Series : TA

■ STANDARD RATINGS

Rated Voltage (SurageVoltage) (V)	Cap (μF)	Case size Φ DxL(mm)	Ripple current (mA/rms105°C) (100KHz)	Impedance (Ω,20°C) (100KHz)	Rated Voltage (SurageVoltage) (V)	Cap (μF)	Case size Φ DxL(mm)	Ripple current (mA/rms105°C) (100KHz)	Impedance (Ω,20°C) (100KHz)	
35V (44)	1800	16x25	2930	0.021	63V (79)	470	16x20	1040	0.091	
		18x20	2860	0.026			560	13x35	1050	0.083
	2200	16x25	2930	0.021		680		16x25	1250	0.073
		16x32	3450	0.017			13x40	1180	0.071	
	2700	18x25	3140	0.019		820	18x20	1240	0.080	
		16x36	3610	0.015			16x32	1570	0.054	
	3300	18x32	4170	0.015		1000	18x25	1490	0.057	
		16x40	4080	0.013			16x36	1790	0.045	
	3900	18x36	4220	0.014		1200	18x32	1630	0.047	
		18x40	4280	0.012			16x40	2020	0.040	
50V (63)	10	5x11	100	1.200	80(100)	68	10x12.5	288	0.430	
	22	5x11	180	0.700		100	10x16	357	0.310	
	33	6.3x11	245	0.490		120	10x20	466	0.210	
	47	6.3x11	300	0.520		150	10x25	490	0.200	
	56	6.3x11	320	0.300			13x16	466	0.230	
	100	8x11	555	0.170		180	10x25	510	0.190	
	120	8x15	730	0.120		220	13x20	690	0.160	
	150	10x12.5	760	0.120		330	13x25	784	0.120	
	180	8x20	910	0.091			16x20	800	0.140	
	220	8x20	910	0.091		390	13x30	905	0.100	
		10x16	1050	0.084			13x25	1050	0.083	
	270	10x20	1220	0.060		470	16x25	1250	0.083	
		13x16	1260	0.061			18x20	1240	0.080	
	330	10x20	1400	0.058		560	13x40	1180	0.071	
		10x25	1440	0.055		680	16x32	1570	0.054	
	470	10x30	1690	0.043			18x25	1490	0.057	
		13x20	1660	0.045		820	16x36	1790	0.045	
	16x16	1690	0.055	18x32			1790	0.045		
	560	13x25	1950	0.034		1000	16x40	2020	0.040	
		18x16	1930	0.054			18x36	2020	0.040	
	680	13x30	2310	0.030		1200	18x40	2330	0.036	
	820	13x35	2510	0.025		100V (125)	15	6.3x11	115	1.200
		16x20	2210	0.034			27	8x12	232	0.630
	1000	13x40	2920	0.021			39	8x15	300	0.450
		16x25	2555	0.025			47	10x12.5	288	0.430
	1200	18x20	2490	0.036			56	8x20	362	0.330
		16x32	3010	0.022			68	10x16	357	0.310
	1500	18x25	2740	0.026			82	10x20	466	0.210
16x36		3150	0.019	13x16	466			0.230		
1800	16x40	3710	0.016	100	10x25		531	0.200		
	18x32	3635	0.021	120	10x30		663	0.150		
2200	18x36	3680	0.017		13x20		690	0.160		
	18x40	3800	0.014	150	16x16		795	0.140		
63V (79)	15	5x11	55	2.300	180		13x25	784	0.120	
	33	6.3x11	115	1.200			18x16	920	0.120	
	56	8x12	232	0.630	220		13x30	905	0.100	
	82	8x15	300	0.450			16x20	1040	0.091	
		10x12.5	288	0.430	270		13x35	1050	0.083	
	120	8x20	362	0.330			16x25	1250	0.073	
		10x16	357	0.310	330		13x40	1180	0.071	
	180	10x20	466	0.210			18x20	1240	0.080	
		13x16	466	0.230	390		16x32	1570	0.054	
	220	10x25	531	0.200			18x25	1490	0.057	
		10x30	663	0.150	470		16x36	1790	0.045	
	270	13x20	690	0.160			18x32	1630	0.047	
		16x16	795	0.140	560		16x40	2020	0.040	
	330	13x25	784	0.120	680		18x36	2020	0.040	
18x16		920	0.120	820	18x40		2330	0.036		
470	13x30	905	0.100							

Jamicon Series : TV

Teapo Series : ST Low impedance · Long life Series(No water)



- Recommended Applications : Applicable for SMPS, Adaptor,Charger,Monitor/Computer
- Corresponding product to RoHS

■ SPECIFICATIONS

Item	Characteristics																											
Category Temperature Range	-55 ~ +105°C																											
Rated Voltage Range	6.3~100VDC																											
Rated Capacitance Range	10 ~ 15000 μ F																											
Capacitance Tolerance	$\pm 20\%$ (120Hz, 20°C)																											
Leakage Current (20°C)	I=0.01CV or 3 μ A whichever is greater. (After rated voltage applied for 2 minutes) I : Max. leakage current (μ A), C : Nominal capacitance (μ F), V : Rated voltage (V)																											
Dissipation Factor(MAX) (tan δ) (120Hz, 20°C)	<table border="1"> <tr> <td>WV</td> <td>6.3</td> <td>10</td> <td>16</td> <td>25</td> <td>35</td> <td>50</td> <td>63</td> <td>100</td> </tr> <tr> <td>tan δ</td> <td>0.22</td> <td>0.19</td> <td>0.16</td> <td>0.14</td> <td>0.12</td> <td>0.14</td> <td>0.14</td> <td>0.14</td> </tr> </table>	WV	6.3	10	16	25	35	50	63	100	tan δ	0.22	0.19	0.16	0.14	0.12	0.14	0.14	0.14									
	WV	6.3	10	16	25	35	50	63	100																			
tan δ	0.22	0.19	0.16	0.14	0.12	0.14	0.14	0.14																				
When nominal capacitance is over 1000 μ F, tan δ shall be added 0.02 to the listed value with increase of every 1000 μ F. Down size tan δ add 3%.																												
Low Temperature Stability Impedance Ratio (MAX)	<table border="1"> <tr> <td>WV</td> <td>6.3</td> <td>10</td> <td>16</td> <td>25</td> <td>35</td> <td>50</td> <td>63</td> <td>100</td> </tr> <tr> <td>Z(120Hz)</td> <td>4</td> <td>3</td> <td>2</td> <td>2</td> <td>2</td> <td>2</td> <td>2</td> <td>2</td> </tr> <tr> <td>Z-25°C / Z+20°C</td> <td>8</td> <td>6</td> <td>4</td> <td>3</td> <td>3</td> <td>3</td> <td>3</td> <td>3</td> </tr> </table>	WV	6.3	10	16	25	35	50	63	100	Z(120Hz)	4	3	2	2	2	2	2	2	Z-25°C / Z+20°C	8	6	4	3	3	3	3	3
	WV	6.3	10	16	25	35	50	63	100																			
	Z(120Hz)	4	3	2	2	2	2	2	2																			
Z-25°C / Z+20°C	8	6	4	3	3	3	3	3																				
Z-55°C / Z+20°C	8	6	4	3	3	3	3	3																				
After applying rated voltage with rated ripple current for 4000~10000hours at 105°C, the capacitors shall meet the following requirements.																												
Endurance	Capacitance change	Within $\pm 25\%$ of initial value																										
	D.F. (tan δ)	Not more than 200% of specified value																										
	Leakage current																											
	Φ D	5~6.3 Φ	8~10 Φ	12.5~18 Φ																								
	6.3~10(V)	4000hrs	6000hrs	8000hrs																								
16~100(V)	5000hrs	7000hrs	10000hrs																									
Shelf Life	The following specifications shall be satisfied when the capacitors are restored to 20°C after exposing them for 1,000 hours at 105°C without voltage applied. Before the measurement, the capacitor shall be preconditioned by applying voltage according to item 4.1 of JIS C 5101-4.																											

■ Dimensions [mm]

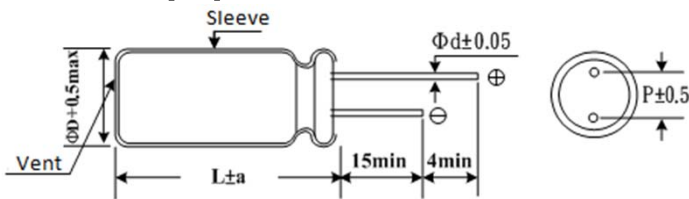

Φ D	5	6.3	8	10	13	16	18
P	2.0	2.5	3.5	5.0	5.0	7.5	7.5
Φ d	0.5	0.5	0.6	0.6	0.6	0.8	0.8
a	1.5	1.5	1.5	1.5	2.0	2.0	2.0

■ Multiplier for Ripple Current

Freq. (Hz)	120	1K	10K	100K
10~180	0.4	0.75	0.90	1.00
220~560	0.5	0.85	0.94	1.00
680~1800	0.6	0.87	0.95	1.00
2200~3900	0.75	0.90	0.95	1.00
4700 μ F Higher	0.85	0.95	0.98	1.00

Jamicon Series : TV

Teapo Series : ST

■ STANDARD RATINGS

Rated Voltage (Surge Voltage) (V)	Cap (μF)	Case size Φ DxL(mm)	Ripple current (mA/rms105°C) (100KHz)	Impedance (Ω,25°C) (100KHz)	Rated Voltage (Surge Voltage) (V)	Cap (μF)	Case size Φ DxL(mm)	Ripple current (mA/rms105°C) (100KHz)	Impedance (Ω,25°C) (100KHz)	
6.3(8)	150	5x11	210	0.720	25 (32)	2700	16x25	2930	0.028	
	330	6.3x11	340	0.380		3300	16x32	3450	0.025	
	680	8x11	640	0.200		3900	18x32	4170	0.015	
	820	8x15	840	0.160		4700	18x36	4280	0.014	
	1000	10x12	865	0.120		35 (44)	33	5x11	210	0.720
	1500	8x20	1050	0.110	47		6.3x11	340	0.380	
		10x15	1210	0.084	150		8x11	640	0.200	
		2200	10x20	1400	0.062		220	8x15	840	0.160
	2700	10x25	1650	0.052	330		10x20	1400	0.062	
	3300	13x20	1900	0.046	470		10x25	1650	0.052	
	3900	13x25	2230	0.034	680		10x30	1910	0.044	
	4700	13x30	2650	0.030				13x20	1900	0.046
	5600	13x35	2880	0.027			820	13x25	2230	0.045
	6800	13x40	3350	0.024	1000		13x25	2230	0.045	
			16x25	2930	0.028		1200	13x30	2650	0.030
16x32		3450	0.025	1500	13x35		2880	0.027		
8200	16x32	3450	0.025	1800	13x40		3350	0.024		
10000	16x36	3610	0.018	2200	16x32		3450	0.025		
12000	18x32	4170	0.015	2700	16x36		3610	0.022		
15000	18x36	4220	0.014	3300	18x36	4220	0.020			
10(13)	100	5x11	210	0.72	50 (63)	10	5x11	120	3.50	
	220	6.3x11	340	0.38		22	5x11	210	2.300	
	470	8x11	640	0.200		33	6.3x11	340	1.200	
	680	8x15	840	0.160		47	6.3x11	340	1.200	
	1000	10x15	1210	0.084		100	8x11	555	0.630	
	1500	10x20	1400	0.062		120	8x15	730	0.450	
	2200	10x25	1650	0.052		150	8x20	910	0.330	
	2700	13x20	1900	0.046		220	10x16	1050	0.310	
	3300	13x25	2230	0.034		330	10x20	1400	0.210	
	3900	13x30	2650	0.030		470	10x30	1690	0.150	
	4700	13x35	2880	0.027				13x20	1660	0.160
	5600	13x40	3350	0.024			560	13x25	1950	0.120
			16x25	2930		0.028	680	13x30	2310	0.100
		16x32	3450	0.025		820	13x35	2510	0.083	
	6800	16x32	3450	0.025		1000	16x25	2555	0.073	
8200	16x36	3610	0.018	1200	16x32	3010	0.054			
10000	18x36	4220	0.014	1500	16x36	3150	0.045			
16 (20)	56	5x11	210	0.720	1800	18x32	3635	0.047		
	100	6.3x11	340	0.380	2200	18x36	3680	0.040		
	220	8x11	640	0.200	2700	18x40	3800	0.036		
	330	8x15	701	0.160	63 (79)	10	5x11	55	2.300	
	470	8x15	840	0.160		33	6.3x11	115	1.200	
	680	10x15	1210	0.084		56	8x11	232	0.630	
	1000	10x20	1400	0.062		120	10x16	357	0.310	
	1500	10x25	1650	0.052		180	10x20	466	0.210	
	2200	13x25	2230	0.034		220	10x25	531	0.200	
	2700	13x30	2650	0.030		270	10x30	663	0.150	
	3300	13x35	2880	0.027				13x20	690	0.160
	3900	13x40	3350	0.024			330	13x25	784	0.120
	4700	16x32	3450	0.028		470	13x30	905	0.100	
	5600	16x36	3610	0.018		560	13x35	1050	0.083	
			18x32	4170		0.015	680	13x40	1180	0.071
18x36		4220	0.014	820		16x32	1570	0.054		
6800	18x36	4220	0.014	1000		16x36	1790	0.045		
25 (32)	47	5x11	210	0.720		1200	16x40	2020	0.040	
	100	6.3x11	340	0.380	100 (125)	10	6.3x11	55	5.000	
	150	8x11	640	0.200		15	6.3x11	70	5.000	
	220	8x11	640	0.200		22	8x11	85	2.700	
	330	8x15	840	0.160		33	8x11	95	2.500	
	470	10x15	1210	0.084		47	8x15	150	1.800	
	680	10x20	1400	0.062		56	8x20	200	1.500	
	820	10x25	1650	0.052		68	10x15	230	1.300	
	1000	13x20	1900	0.046						
	1500	13x25	2230	0.034						
2200	13x35	2880	0.027							

Jamicon Series : TV

Teapo Series : ST

■ STANDARD RATINGS

Rated Voltage (SurageVoltage) (V)	Cap (μ F)	Case size Φ D \times L(mm)	Ripple current (mA/rms105°C) (100KHz)	Impedance (Ω ,25°C) (100KHz)
100 (125)	82	10x20	250	1.200
	100	10x20	330	0.950
	120	10x25	400	0.800
	150	13x20	460	0.900
	220	13x25	640	0.600
	330	16x25	720	0.570

Rated Voltage (SurageVoltage) (V)	Cap (μ F)	Case size Φ D \times L(mm)	Ripple current (mA/rms105°C) (100KHz)	Impedance (Ω ,25°C) (100KHz)
100 (125)	470	16x32	770	0.550
		18x25	840	0.500
	680	18x36	1400	0.180
	820	18x40	1850	0.130
	1000	18x40	1850	0.130

Jamicon Series : SA

Teapo Series : TT

Low impedance · Long life · Miniaturization Series(No water)



■ Endurance: 105°C 5000hrs

■ Recommended Applications : Apply to the requirement of long life, low impedance, high reliability, etc.

■ Corresponding product to RoHS

■ SPECIFICATIONS

Item	Characteristics						
Category Temperature Range	-40 ~ +105°C						
Rated Voltage Range	6.3 ~ 50VDC						
Rated Capacitance Range	1~270 μF						
Capacitance Tolerance	± 20 % (120Hz , 20°C)						
Leakage Current (20°C)	I=0.03CV or 3 μA whichever is greater. (After rated voltage applied for 2 minutes) I : Max. leakage current (μA), C : Nominal capacitance (μF), V : Rated voltage (V)						
Dissipation Factor(MAX) (tan δ) (120Hz ,20°C)	WV	6.3	10	16	25	35	50
	tan δ	0.5	0.4	0.35	0.3	0.25	0.25
Low Temperature Stability Impedance Ratio (MAX)	WV	6.3	10	16	25	35	50
	Z(120Hz) Z-25°C / Z+20°C	4	3	2	2	2	2
	Z-40°C / Z+20°C	8	6	4	3	3	3
Endurance	After applying rated voltage with rated ripple current for 5000hours at 105°C, the capacitors shall meet the following requirements.						
	Capacitance change	Within ± 30% of initial value					
	D.F. (tan δ)	Not more than 300% of specified value					
Shelf Life	The following specifications shall be satisfied when the capacitors are restored to 20°C after exposing them for 1,000 hours at 105°C without voltage applied. Before the measurement, the capacitor shall be preconditioned by applying voltage according to item 4.1 of JIS C 5101-4.						
	Capacitance change	Within ± 25% of initial value					
	D.F. (tan δ)	Not more than 200% of specified value					
	Leakage current	Not more than the specified value					

■ Dimensions [mm]

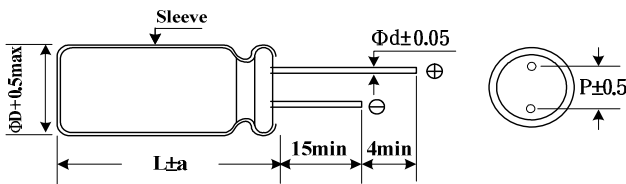

Vent only for 8Φ

ΦD	4	5	6.3	8
P	1.5	2.0	2.5	3.5
Φd	0.45	0.45	0.45	(0.45)0.5
a	1.0	1.0	1.0	1.0

() : L = 5

■ Multiplier for Ripple Current

Freq. (Hz)	120	1 K	10 K	100 K
1~3.3 μF	0.20	0.66	0.90	1.00
4.7~6.8 μF	0.35	0.70	0.90	1.00
10~150 μF	0.40	0.75	0.90	1.00
220~270 μF	0.50	0.85	0.94	1.00

Jamicon Series : SA

Teapo Series : TT

■ STANDARD RATINGS

Rated Voltage (SurageVoltage) (V)	Cap (μ F)	Case size Φ DxL(mm)	Ripple current (mA/rms105°C) (100KHz)	Impedance (Ω ,20°C) (100KHz)	Rated Voltage (SurageVoltage) (V)	Cap (μ F)	Case size Φ DxL(mm)	Ripple current (mA/rms105°C) (100KHz)	Impedance (Ω ,20°C) (100KHz)
6.3V (8)	33	4x5	37	5.4	25V (32)	15	4x7	44	4.5
	47	4x7	44	4.5			5x5	57	3.1
	56	5x5	57	3.1		22	5x7	70	2.5
	82	5x7	70	2.5		33	6.3x5	82	1.7
	100	6.3x5	82	1.7		56	6.3x7	116	1.3
	150	6.3x7	116	1.3		68	8x5	110	1.5
	220	8x5	110	1.5		100	8x7	162	0.9
	270	8x7	162	0.9		4.7	4x5	37	5.4
10V (13)	22	4x5	37	5.4	35V (44)	6.8	4x7	44	4.5
	33	4x7	44	4.5		10	5x5	57	3.1
		5x5	57	3.1			5x7	70	2.5
	47	5x7	70	2.5		22	6.3x5	82	1.7
	68	6.3x5	82	1.7			6.3x7	116	1.3
	100	6.3x7	116	1.3		33	8x5	110	1.5
	150	8x5	110	1.5		47	8x7	162	0.9
	220	8x7	162	0.9		50V (63)	1.0	4x5	18
16V (20)	15	4x5	37	5.4	2.2		4x5	22	14
	22	4x7	44	4.5	3.3		4x5	26	11
		5x5	57	3.1	4.7		4x7	30	9
	33	5x7	70	2.5			5x5	40	6
	47	6.3x5	82	1.7	6.8		5x7	50	4.8
	68	6.3x7	116	1.3	10		6.3x5	63	2.9
	100	8x5	110	1.5	15		6.3x7	90	2.2
	150	8x7	162	0.9	22	8x5	84	2.6	
25V (32)	10	4x5	37	5.4		8x7	120	1.6	

Jamicon Series : TQ

Teapo Series : TB Low impedance · High Ripple Series

- Endurance:105°C 5000~6000hours
- Recommended Applications :AV(TV, Video, Audio), Monitor/Computer, OA/HA/Communication,Converter/Inverter,Adapter, SMPS
- Corresponding product to RoHS



SPECIFICATIONS

Item	Characteristics																								
Category Temperature Range	-40 ~ +105°C																								
Rated Voltage Range	6.3~35VDC																								
Rated Capacitance Range	47~ 8200 μF																								
Capacitance Tolerance	± 20 % (120Hz , 20°C)																								
Leakage Current (20°C)	I=0.01CV or 3 μ A whichever is greater. (After rated voltage applied for 2 minutes) I : Max. leakage current (μ A), C : Nominal capacitance (μ F), V : Rated voltage (V)																								
Dissipation Factor(MAX) (tan δ) (120Hz ,20°C)	<table border="1"> <tr> <td>WV</td> <td>6.3</td> <td>10</td> <td>16</td> <td>25</td> <td>35</td> </tr> <tr> <td>tan δ</td> <td>0.22</td> <td>0.19</td> <td>0.16</td> <td>0.14</td> <td>0.12</td> </tr> </table>	WV	6.3	10	16	25	35	tan δ	0.22	0.19	0.16	0.14	0.12												
	WV	6.3	10	16	25	35																			
tan δ	0.22	0.19	0.16	0.14	0.12																				
When nominal capacitance is over 1000 μ F,tan δ shall be added 0.02 to the listed value with increase of every 1000 μ F.																									
Low Temperature Stability Impedance Ratio (MAX)	<table border="1"> <tr> <td>WV</td> <td>6.3</td> <td>10</td> <td>16</td> <td>25</td> <td>35</td> </tr> <tr> <td>Z(120Hz)</td> <td></td> <td></td> <td></td> <td></td> <td></td> </tr> <tr> <td>Z-25°C / Z+20°C</td> <td>4</td> <td>3</td> <td>2</td> <td>2</td> <td>2</td> </tr> <tr> <td>Z-40°C / Z+20°C</td> <td>8</td> <td>6</td> <td>4</td> <td>3</td> <td>3</td> </tr> </table>	WV	6.3	10	16	25	35	Z(120Hz)						Z-25°C / Z+20°C	4	3	2	2	2	Z-40°C / Z+20°C	8	6	4	3	3
	WV	6.3	10	16	25	35																			
	Z(120Hz)																								
Z-25°C / Z+20°C	4	3	2	2	2																				
Z-40°C / Z+20°C	8	6	4	3	3																				
Endurance	After applying rated voltage with rated ripple current for 5000~6000hours at 105°C, the capacitors shall meet the following requirements.																								
	<table border="1"> <tr> <td>Capacitance change</td> <td colspan="2">Within ± 25% of initial value(6.3 · 10V : ± 30%)</td> </tr> <tr> <td>D.F. (tan δ)</td> <td colspan="2">Not more than 200% of specified value</td> </tr> <tr> <td>Leakage current</td> <td colspan="2">initial specified value or less</td> </tr> </table>	Capacitance change	Within ± 25% of initial value(6.3 · 10V : ± 30%)		D.F. (tan δ)	Not more than 200% of specified value		Leakage current	initial specified value or less																
	Capacitance change	Within ± 25% of initial value(6.3 · 10V : ± 30%)																							
	D.F. (tan δ)	Not more than 200% of specified value																							
	Leakage current	initial specified value or less																							
<table border="1"> <tr> <td>DΦ</td> <td>5~6.3Φ</td> <td>8~16Φ</td> </tr> <tr> <td>life(hours)</td> <td>5000hrs</td> <td>6000hrs</td> </tr> </table>	DΦ	5~6.3Φ	8~16Φ	life(hours)	5000hrs	6000hrs																			
DΦ	5~6.3Φ	8~16Φ																							
life(hours)	5000hrs	6000hrs																							
Shelf Life	The following specifications shall be satisfied when the capacitors are restored to 20°C after exposing them for 500 hours at 105°C without voltage applied. Before the measurement, the capacitor shall be preconditioned by applying voltage according to item 4.1 of JIS C 5101-4.																								

Dimensions [mm]

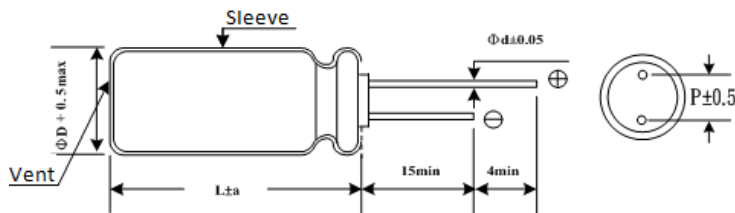

ΦD	5	6.3	8	10	13	16
P	2.0	2.5	3.5	5.0	5.0	7.5
Φd	0.5	0.5	0.6	0.6	0.6	0.8
a	1.5	1.5	1.5	1.5	2.0	2.0

Multiplier for Ripple Current

Freq. (Hz)	120	1K	10K	100K
47~150 μ F	0.40	0.75	0.90	1.00
220 ~ 560 μ F	0.50	0.85	0.94	1.00
680 ~ 1800 μ F	0.60	0.87	0.95	1.00
2200 ~ 3900 μ F	0.75	0.90	0.95	1.00
4700 ~8200 μ F	0.85	0.95	0.98	1.00

Jamicon Series : TQ

Teapo Series : TB

■ STANDARD RATINGS

Rated Voltage (SurageVoltage) (V)	Cap (μF)	Case size Φ DxL(mm)	Ripple current (mA/rms105°C) (100KHz)	Impedance (Ω,20°C) (100KHz)	Rated Voltage (SurageVoltage) (V)	Cap (μF)	Case size Φ DxL(mm)	Ripple current (mA/rms105°C) (100KHz)	Impedance (Ω,20°C) (100KHz)
6.3V (8)	220	5x11	330	0.24	16V (20)	1800	10x25	2250	0.025
	470	6.3x11	500	0.11		2200	13x20	2480	0.025
	820	8x12	900	0.062		2700	13x25	2900	0.022
	1200	8x15	1210	0.048		3300	13x30	3450	0.018
		10x12.5	1240	0.053			16x20	3250	0.020
	1500	8x20	1410	0.041		3900	13x35	3570	0.017
	1800	10x16	1650	0.038		4700	16x25	3630	0.018
	2200	10x20	1960	0.026		25V (32)	68	5x11	330
	2700	10x25	2250	0.020	150		6.3x11	500	0.11
	3900	13x20	2480	0.023	330		8x12	900	0.062
	4700	13x25	2900	0.020	390		8x15	1210	0.048
	5600	13x30	3450	0.017	470		10x12.5	1240	0.053
	6800	13x35	3570	0.016	560		8x20	1410	0.041
		16x20	3250	0.018	680		10x16	1650	0.038
8200	16x25	3630	0.017	820	10x20		1960	0.026	
10V (13)	150	5x11	330	0.24	1000		10x25	2250	0.023
	330	6.3x11	500	0.11	1500		13x20	2480	0.023
	680	8x12	900	0.062	1800		13x25	2900	0.020
	1000	8x15	1210	0.048	2200		13x30	3450	0.017
		10x12.5	1240	0.053			16x20	3250	0.019
	1500	8x20	1410	0.041	2700		13x35	3570	0.016
		10x16	1650	0.038	3300	16x25	3630	0.017	
	1800	10x20	1960	0.026	35V (44)	47	5x11	330	0.24
	2200	10x25	2250	0.023		100	6.3x11	500	0.11
	3300	13x20	2480	0.023		220	8x12	900	0.062
	3900	13x25	2900	0.020		270	8x15	1210	0.050
	4700	13x30	3450	0.017		330	10x12.5	1240	0.053
		16x20	3250	0.018		390	8x20	1410	0.041
	5600	13x35	3570	0.016		470	10x16	1650	0.038
6800	16x25	3630	0.017	560		10x20	1960	0.026	
16V (20)	100	5x11	330	0.24		680	10x25	2250	0.023
	220	6.3x11	500	0.11		1000	13x20	2480	0.023
	470	8x12	900	0.062		1200	13x25	2900	0.022
	680	8x15	1210	0.048		1500	13x30	3450	0.018
		10x12.5	1240	0.053			16x20	3250	0.020
	1000	8x20	1410	0.041		1800	13x35	3570	0.018
		10x16	1650	0.038	2200	16x25	3630	0.017	
	1500	10x20	1960	0.026					

Jamicon Series : TU

Teapo Series : TC Low impedance · Long life Series

- Endurance:105°C 6000~10000hours
- Recommended Applications :Applicable forAV(TV,Video,Audio),
OA/HA/Communication, SMPS, Adapter,Monitor/Computer,Converter/Inverter
- Corresponding product to RoHS



SPECIFICATIONS

Item	Characteristics									
Category Temperature Range	-40 ~ +105°C									
Rated Voltage Range	6.3~100VDC									
Rated Capacitance Range	8.2 ~ 8200 μF									
Capacitance Tolerance	± 20 % (120Hz , 20°C)									
Leakage Current (20°C)	I=0.01CV or 3 μ A whichever is greater. (After rated voltage applied for 2 minutes) I : Max. leakage current (μ A), C : Nominal capacitance (μ F), V : Rated voltage (V)									
Dissipation Factor(MAX) (tan δ) (120Hz ,20°C)	WV	6.3	10	16	25	35	50	63	80	100
	tan δ	0.22	0.19	0.16	0.14	0.12	0.10	0.09	0.08	0.08
When nominal capacitance is over 1000 μ F,tan δ shall be added 0.02 to the listed value with increase of every 1000 μ F.										
Low Temperature Stability Impedance Ratio (MAX)	WV	6.3	10	16	25	35	50	63	80	100
	Z(120Hz)									
	Z-25°C / Z+20°C	4	3	2	2	2	2	2	2	2
	Z-40°C / Z+20°C	8	6	4	3	3	3	3	3	3
Endurance	After applying rated voltage with rated ripple current for 6000~10000hours at 105°C, the capacitors shall meet the following requirements.									
	Capacitance change	Within ± 25% of initial value(6.3 · 10V : ± 30%)								
	D.F. (tan δ)	Not more than 200% of specified value								
	Leakage current	initial specified value or less								
	D Φ	5-6.3 Φ	8 Φ	10~18 Φ						
Life	6000hrs	8000hrs	10000hrs							
Shelf Life	The following specifications shall be satisfied when the capacitors are restored to 20°C after exposing them for1,000 hours at 105°C without voltage applied. Before the measurement, the capacitor shall be preconditioned by applying voltage according to item 4.1 of JIS C 5101-4.									

Dimensions [mm]

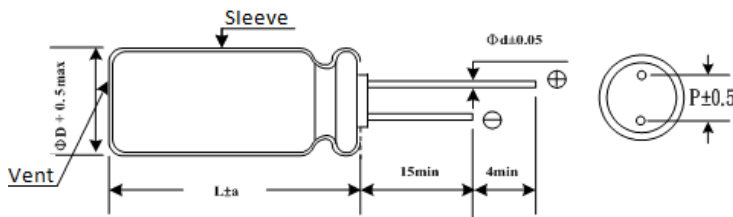

ΦD	5	6.3	8	10	13	16	18
P	2.0	2.5	3.5	5.0	5.0	7.5	7.5
Φd	0.5	0.5	0.6	0.6	0.6	0.8	0.8
a	1.5	1.5	1.5	1.5	2.0	2.0	2.0

Multiplier for Ripple Current

Freq. (Hz)	120	1K	10K	100K
8.2 ~ 33	0.42	0.70	0.90	1.00
47 ~ 270	0.50	0.73	0.92	1.00
330 ~680	0.55	0.77	0.94	1.00
820 ~ 1800	0.60	0.80	0.96	1.00
2200 ~8200	0.70	0.85	0.98	1.00

Jamicon Series : TU

Teapo Series : TC

■ STANDARD RATINGS

Rated Voltage (SurageVoltage) (V)	Cap (μF)	Case size Φ DxL(mm)	Ripple current (mA/rms105°C) (100KHz)	Impedance (Ω,20°C) (100KHz)	Rated Voltage (SurageVoltage) (V)	Cap (μF)	Case size Φ DxL(mm)	Ripple current (mA/rms105°C) (100KHz)	Impedance (Ω,20°C) (100KHz)
6.3V (8)	220	5x11	345	0.242	35V (44)	220	8x12	945	0.060
	470	6.3x11	540	0.103		270	8x16	1250	0.050
	820	8x12	945	0.062		330	10x12.5	1330	0.041
	1200	8x16	1250	0.050		390	8x20	1500	0.032
		10X12.5	1330	0.043		470	10x16	1760	0.030
	1500	8x20	1500	0.032		560	10x20	1960	0.025
	1800	10x16	1760	0.031		680	10x25	2250	0.023
	2200	10x20	1960	0.022		1000	13x20	2480	0.025
	2700	10x25	2250	0.020		1200	13x25	2900	0.022
	3900	13x20	2480	0.019		1500	13x30	3450	0.018
	4700	13x25	2900	0.017			16x20	3250	0.020
	5600	13x30	3450	0.014		1800	13x35	3570	0.018
	6800	16x20	3250	0.017		2200	16x25	3630	0.015
		13x35	3570	0.013					
8200	16x25	3630	0.014						
10V (13)	150	5x11	345	0.242	50V (63)	27	5x11	238	0.340
	330	6.3x11	540	0.103		56	6.3x11	385	0.140
	680	8x12	945	0.062		100	8x12	724	0.074
	1000	8x16	1250	0.050		120	8x16	950	0.061
		10x12.5	1330	0.043		150	10x12.5	979	0.061
	1500	8x20	1500	0.032		180	8x20	1190	0.046
		10x16	1760	0.031		220	10x16	1370	0.042
	1800	10x20	1960	0.022		270	10x20	1580	0.030
	2200	10x25	2250	0.020		330	10x25	1870	0.028
	3300	13x20	2480	0.019		470	13x20	2050	0.027
	3900	13x25	2900	0.017		560	13x25	2410	0.023
	4700	13x30	3450	0.014		680	13x30	2860	0.021
		16x20	3250	0.017		820	13x35	2960	0.019
	5600	13x35	3570	0.013		1000	16x20	2730	0.023
6800	16x25	3630	0.014	16x25	3010		0.021		
16V (20)	100	5x11	345	0.242	63V (79)	18	5x11	173	1.000
	220	6.3x11	540	0.103		47	6.3x11	278	0.560
	470	8x12	945	0.062		82	8x12	525	0.264
	680	8x16	1250	0.050		100	8x16	688	0.192
		10x12.5	1330	0.043		120	10x12.5	725	0.180
	1000	8x20	1500	0.032		150	8x20	861	0.144
		10x16	1760	0.031		180	10x16	998	0.132
	1500	10x20	1960	0.025		270	10x20	1200	0.094
	1800	10x25	2250	0.025			13x16	1200	0.098
	2200	13x20	2480	0.025		330	10x25	1410	0.083
	2700	13x25	2900	0.022		390	13x20	1570	0.072
	3300	13x30	3450	0.018		470	13x25	1990	0.052
		16x20	3250	0.020		560	13x30	2410	0.042
	3900	13x35	3570	0.017			16x20	2100	0.052
4700	16x25	3630	0.018	680	13x35	2620	0.040		
25V (32)	68	5x11	345	0.242	80V (100)	820	13x40	2940	0.032
	150	6.3x11	540	0.103			16x25	2730	0.038
	330	8x12	945	0.062		18x20	2500	0.046	
	390	8x16	1250	0.050			16x32	2990	0.029
	470	10x12.5	1330	0.043		1200	18x25	2800	0.037
	560	8x20	1500	0.032			1500	16x36	3040
	680	10x16	1760	0.031		18x32		3300	0.030
	820	10x20	1960	0.025		1800	16x40	3570	0.023
	1000	10x25	2250	0.022			18x36	3570	0.024
	1500	13x20	2480	0.021		2200	18x40	3670	0.022
	1800	13x25	2900	0.020			12	5x11	163
	2200	13x30	3450	0.016		33	6.3x11	267	0.570
		16x20	3250	0.019		56	8x12	462	0.360
	2700	13x35	3570	0.015		68	8x16	585	0.250
3300	16x25	3630	0.016	82	10x12.5	624	0.230		
35V (44)	47	5x11	345	0.220	100	8x20	735	0.190	
	100	6.3x11	540	0.094	120	10x16	780	0.170	
					180	10x20	1040	0.120	
						13x16	975	0.130	

Jamicon Series : TU

Teapo Series : TC

■ STANDARD RATINGS

Rated Voltage (SurageVoltage) (V)	Cap (μ F)	Case size Φ DxL(mm)	Ripple current (mA/rms105°C) (100KHz)	Impedance (Ω ,20°C) (100KHz)
80V (100)	220	10x25	1170	0.110
	270	13x20	1430	0.085
	330	13x25	1620	0.060
	390	13x30	1950	0.051
		16x20	1750	0.058
	470	13x35	2140	0.043
	560	13x40	2340	0.036
		16x25	2210	0.044
		18x20	1950	0.054
	680	16x32	2400	0.033
	820	16x36	2600	0.029
		18x25	2270	0.038
	1000	16x40	2860	0.027
		18x32	2470	0.031
1200	18x36	2860	0.027	
1500	18x40	3510	0.026	
100V (125)	8.2	5x11	163	1.400
	18	6.3x11	267	0.570
	33	8x12	462	0.360
	47	8x16	585	0.250
	56	10x12.5	624	0.230

Rated Voltage (SurageVoltage) (V)	Cap (μ F)	Case size Φ DxL(mm)	Ripple current (mA/rms105°C) (100KHz)	Impedance (Ω ,20°C) (100KHz)
100V (125)	68	8x20	735	0.190
	82	10x16	780	0.170
	100	10x20	1040	0.120
		13x16	975	0.130
	120	10x25	1170	0.110
	150	13x20	1430	0.085
	220	13x25	1620	0.060
	270	13x30	1950	0.051
		16x20	1750	0.058
	330	13x35	2140	0.043
	390	13x40	2340	0.036
		16x25	2210	0.044
		18x20	1950	0.054
	470	16x32	2400	0.033
		18x25	2270	0.038
	560	16x36	2600	0.029
		18x32	2470	0.031
	680	16x40	2860	0.027
		18x36	2860	0.027
	820	18x40	3510	0.026

Jamicon Series : TC

Teapo Series : SQ High Ripple Series

- Endurance: 105°C 2000 hours
- Recommended Applications : AV(TV, Video, Audio); Monitor/Computer; OA/HA/Communication; Converter/Inverter; Energy saving lamp; PFC circuit; SMPS; Ballast; Adapter
- Corresponding product to RoHS



SPECIFICATIONS

Item	Characteristics							
Category Temperature Range	-40~+105°C							
Rated Voltage Range	160 ~ 500VDC							
Rated Capacitance Range	2.2 ~ 220 μF							
Capacitance Tolerance	± 20 % (120Hz , 20°C)							
Leakage Current (20°C)	I=0.03CV +10 μ A (After rated voltage applied for 2 minutes) I : Max. leakage current (μ A), C : Nominal capacitance (μ F), V : Rated voltage (V)							
Dissipation Factor(MAX) (tan δ) (120Hz ,20°C)	WV	160	200	250	350	400	420~450	
	tan δ	0.15	0.15	0.15	0.24	0.24	0.24	
Low Temperature Stability Impedance Ratio (MAX)	WV							
	Z (120Hz)	160	200	250	350	400	420~450	
	Z(-25°C) / Z(20°C)	3	3	3	5	5	6	
	Z(-40°C) / Z(20°C)	4	4	4	6	6	8	
Endurance	After applying rated voltage with rated ripple current for 2000 hours at 105°C, the capacitors shall meet the following requirements.							
	Capacitance change	Within ± 20% of initial value						
	D.F. (tan δ)	Not more than 200% of specified value						
	Leakage current	Not more than the specified value						
Shelf Life	The following specifications shall be satisfied when the capacitors are restored to 20°C after exposing them for 1,000 hours at 105°C without voltage applied. Before the measurement, the capacitor shall be preconditioned by applying voltage according to item 4.1 of JIS C 5101-4.							

Dimensions [mm]

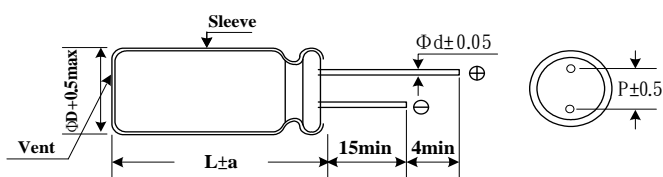

ΦD	8	10	12.5	13	16	18
P	3.5	5	5.0	5	7.5	7.5
Φd	0.6	0.6	0.6	0.6	0.8	0.8
a	1.5(2.0)	1.5(2.0)	2.0(2.5)	2.0	2.0	2.0

Notes : ():L ≥ 30mm

Multiplier for Ripple Current

Freq. (Hz)		50	120	1K	10K	100K
Coefficient	< 33 μF	0.80	1.00	1.36	1.54	1.80
	≥ 33 μF	0.85	1.00	1.28	1.35	1.40

Jamicon Series : TC

Teapo Series : SQ

■ STANDARD RATINGS

Rated Voltage (SurageVoltage) (V)	Cap (μF)	Case size Φ DxL(mm)	Ripple current (mA/rms105°C) (120Hz)	Ripple current (mA/rms105°C) (100KHz)	Rated Voltage (SurageVoltage) (V)	Cap (μF)	Case size Φ DxL(mm)	Ripple current (mA/rms105°C) (120Hz)	Ripple current (mA/rms105°C) (100KHz)
160(200)	22	10x20	195	350	400(450)	39	8x52	320	448
	33	13x20	315	450			10x40	320	448
	47	13x25	420	600		47	10x45	355	500
	68	13x25	420	600			12.5x40	365	510
	100	16x25	665	950			16x25	350	490
	220	18x36	980	1400			18x32	600	860
200(250)	22	10x20	195	350		56	10x50	405	566
	33	13x20	365	520			12.5x40	405	566
	47	13x25	420	600			10x55	460	640
	68	16x25	665	950			12.5x45	460	640
	100	16x32	840	1200		68	16x30	510	714
250(300)	10	10x20	120	220			16x32	550	770
	22	8x30	200	360			12.5x50	525	735
		13x25	165	300		82	18x32	680	952
	27	8x35	215	380			18x32	750	1050
	33	8x35	240	336	150	18x36	800	1120	
		13x25	280	400	420(470)	15	8x35	150	270
	39	8x40	260	360		22	8x40	195	350
		10x30	275	500		27	8x45	220	396
	47	8x45	310	558			10x35	220	396
		16x25	505	720		33	8x50	285	400
	56	10x40	350	490			10x40	285	400
	68	10x40	400	560		39	10x42	310	430
		16x32	570	810			12.5x35	320	448
	82	10x45	450	630		47	10x45	350	490
		10x50	525	940			12.5x40	350	490
100	18x36	735	1050	56		10x52	390	545	
	12.5x45	725	1015			12.5x42	390	545	
350(400)	2.2	10x16	30	50		68	12.5x45	450	630
	3.3	10x16	35	60		82	12.5x52	535	750
	4.7	10x20	45	78		450(500)	2.2	10x16	60
	10	13x20	75	130	3.3		10x20	75	135
	15	8x30	140	250	4.7		13x20	105	190
		8x35	180	324	10		13x25	140	250
	22	16x25	115	205	12		8x30	115	210
		8x40	210	380	15		8x35	135	240
	27	8x42	240	336	22		8x42	190	340
		16x32	180	255			10x30	190	340
	39	10x40	280	390			13x20	180	324
		10x45	325	455			13x25	200	360
	47	18x32	225	320	16x32		265	480	
		10x50	380	530	27		8x45	210	378
	56	12.5x40	430	602			10x35	210	378
68	12.5x45	500	700	33	8x52		290	406	
	12.5x50	630	880		10x42		290	406	
100	18x45	370	530		16x25	350	500		
	2.2	10x16	80		140	18x36	455	650	
400(450)	3.3	10x20	110	195	39	10x45	320	448	
	4.7	10x25	120	220		12.5x40	330	460	
	15	8x35	170	306	47	10x50	360	500	
	10	10x16	135	243		12.5x42	370	666	
		13x25	200	360	16x25	380	532		
	22	8x40	220	395	56	12.5x45	415	580	
		13x20	240	432		12.5*50	475	665	
		13x25	265	477	68	18x25	470	658	
		16x25	315	570		12.5x55	535	750	
	27	8x45	250	350	82	18x36	520	720	
		10x35	250	350		100	18x40	620	860
	33	8x50	295	410	120		18x40	650	910
		10x40	295	410		18x45	720	1000	
		16x32	490	700					

凯美系列：TC

智寶系列：SQ

■标准品规格一览表

Rated Voltage (SurageVoltage) (V)	Cap (μ F)	Case size Φ D \times L(mm)	Ripple current (mA/rms105 $^{\circ}$ C) (120Hz)	Ripple current (mA/rms105 $^{\circ}$ C) (100KHz)	Rated Voltage (SurageVoltage) (V)	Cap (μ F)	Case size Φ D \times L(mm)	Ripple current (mA/rms105 $^{\circ}$ C) (120Hz)	Ripple current (mA/rms105 $^{\circ}$ C) (100KHz)
500(550)	22	12.5x35	158	280	500(550)	68	16x45	180	250
	33	12.5x45	162	290		82	16x50	190	260
	39	12.5x50	168	235		100	18x45	200	280
	47	16x40	175	245		120	18x50	220	310

Jamicon Series : TH

Teapo Series : TH High Ripple · Low impedance Series

- Endurance: 105°C 3000 hours
- Recommended Applications : AV(TV, Video, Audio); Monitor/Computer; OA/HA/Communication; Converter/Inverter; Energy saving lamp; PFC circuit; SMPS; Ballast; Adapter
- Corresponding product to RoHS

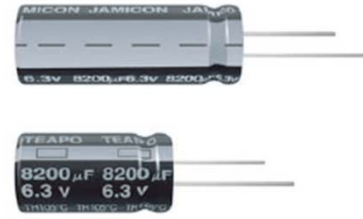

SPECIFICATIONS

Item	Characteristics															
Category Temperature Range	-40~+105°C	-25~+105°C														
Rated Voltage Range	160 ~ 400VDC	420~450VDC														
Rated Capacitance Range	2.2 ~ 220 μ F															
Capacitance Tolerance	\pm 20 % (120Hz , 20°C)															
Leakage Current (20°C)	I=0.06CV +10 μ A (After rated voltage applied for 2 minutes) I : Max. leakage current (μ A), C : Nominal capacitance (μ F), V : Rated voltage (V)															
Dissipation Factor(MAX) (tan δ) (120Hz, 20°C)	<table border="1"> <tr> <td>WV</td> <td>160</td> <td>200</td> <td>250</td> <td>350</td> <td>400</td> <td>420~450</td> </tr> <tr> <td>tan δ</td> <td>0.15</td> <td>0.15</td> <td>0.15</td> <td>0.24</td> <td>0.24</td> <td>0.24</td> </tr> </table>		WV	160	200	250	350	400	420~450	tan δ	0.15	0.15	0.15	0.24	0.24	0.24
WV	160	200	250	350	400	420~450										
tan δ	0.15	0.15	0.15	0.24	0.24	0.24										
Low Temperature Stability Impedance Ratio (MAX)	<table border="1"> <tr> <td rowspan="3">Z (120Hz)</td> <td>WV</td> <td>160~250</td> <td>400</td> <td>420~450</td> </tr> <tr> <td>Z(-25°C) / Z(20°C)</td> <td>3</td> <td>5</td> <td>6</td> </tr> <tr> <td>Z(-40°C) / Z(20°C)</td> <td>4</td> <td>6</td> <td>—</td> </tr> </table>		Z (120Hz)	WV	160~250	400	420~450	Z(-25°C) / Z(20°C)	3	5	6	Z(-40°C) / Z(20°C)	4	6	—	
Z (120Hz)	WV	160~250		400	420~450											
	Z(-25°C) / Z(20°C)	3		5	6											
	Z(-40°C) / Z(20°C)	4	6	—												
Endurance	After applying rated voltage with rated ripple current for 2000 (\geq 10 ϕ 3000) hours at 105°C, the capacitors shall meet the following requirements. <table border="1"> <tr> <td>Capacitance change</td> <td>Within \pm 20% of initial value</td> </tr> <tr> <td>D.F. (tan δ)</td> <td>Not more than 200% of specified value</td> </tr> <tr> <td>Leakage current</td> <td>Not more than the specified value</td> </tr> </table>		Capacitance change	Within \pm 20% of initial value	D.F. (tan δ)	Not more than 200% of specified value	Leakage current	Not more than the specified value								
Capacitance change	Within \pm 20% of initial value															
D.F. (tan δ)	Not more than 200% of specified value															
Leakage current	Not more than the specified value															
Shelf Life	The following specifications shall be satisfied when the capacitors are restored to 20°C after exposing them for 1,000 hours at 105°C without voltage applied. Before the measurement, the capacitor shall be preconditioned by applying voltage according to item 4.1 of JIS C 5101-4.															

Dimensions [mm]

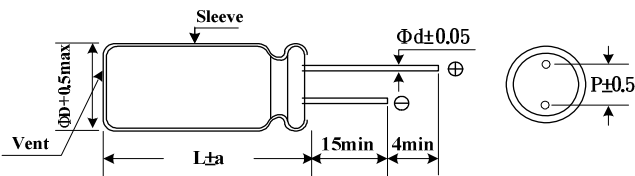

ΦD	10	12.5	16	18
P	5.0	5.0	7.5	7.5
Φd	0.6	0.6	0.8	0.8
a	1.5	2.0	2.0	2.0

Notes : (): L \geq 30mm

Multiplier for Ripple Current

(Hz)	Freq.	120	1k	10k	100k
	160~450	0.5	0.80	0.90	1.00

Jamicon Series : TH

Teapo Series : TH

■ STANDARD RATINGS

Rated Voltage (SurageVoltage) (V)	Cap (μ F)	Case size Φ D \times L(mm)	Ripple current (mA/rms105°C) (100kHz)	Impedance (Ω ,20°C) (100KHz)	Rated Voltage (SurageVoltage) (V)	Cap (μ F)	Case size Φ D \times L(mm)	Ripple current (mA/rms105°C) (100kHz)	Impedance (Ω ,20°C) (100KHz)
160v (200)	10	10x16	220	1.47	250v (300)	100	18x36	1110	0.59
	22	10x20	350	0.80		220	18x40	1730	0.31
	33	10x20	430	0.62	400v (450)	3.3	10x20	170	2.6
	47	12.5x20	550	0.50		4.7	10x25	220	2.2
	68	12.5x20	660	0.39		10	12.5x25	340	1.72
	100	16x25	890	0.32		22	16x25	510	0.94
	220	16x36	1540	0.17		33	16x32	690	0.73
200v (250)	10	10x16	220	1.47		47	16x32	820	0.59
	22	10x20	350	0.80		68	16x32	990	0.46
	33	12.5x20	460	0.62		100	18x32	1280	0.38
	47	12.5x25	610	0.50		120	18x36	1480	0.32
	68	12.5x25	730	0.39	150	18x40	1740	0.26	
	100	16x32	980	0.32	180	18x40	1910	0.23	
	220	18x36	1640	0.17	450v (500)	2.2	10x16	110	4.94
250v (300)	4.7	10x16	150	3.45		3.3	10x20	150	4.11
	10	10x20	240	2.70		4.7	12.5x20	190	3.47
	22	12.5x20	380	1.47		10	12.5x25	300	2.72
	33	12.5x25	510	1.15		22	16x32	500	1.48
	47	16x25	610	0.92		33	16x32	620	1.15
	68	16x32	810	0.71		47	18x32	780	0.92

Jamicon Series : TJ

Teapo Series : SG

High Ripple · Long life Series

■ Endurance: 105°C · 5000hours

■ Recommended Applications : High ripple current for Electronic Ballast , Power Supply...etc

■ Corresponding product to RoHS



SPECIFICATIONS

Item	Characteristics	
Category Temperature Range	-40~+105°C	-25~+105°C
Rated Voltage Range	160 ~ 450VDC	500VDC
Rated Capacitance Range	3.3 ~ 330 μF	4.7~ 150 μF
Capacitance Tolerance	± 20 % (120Hz , 20°C)	± 20 % (120Hz , 20°C)
Leakage Current (20°C)	I=0.06CV + 10(μA) (After rated voltage applied for 2 minutes) I : Max. leakage current (μA), C : Nominal capacitance (μF), V : Rated voltage (V)	
Dissipation Factor(MAX) (tan δ) (120Hz, 20°C)	WV	160 200 250 350 400 420~450 500
	tan δ	0.15 0.15 0.15 0.20 0.24 0.24 0.24
Low Temperature Stability Impedance Ratio (MAX)	Z (120Hz)	160 200 250 350 400 420~450 500
	Z-25°C / Z+20°C	3 3 3 5 5 6 6
	Z-40°C / Z+20°C	6 6 6 6 6 8 —
Endurance	After applying rated voltage with rated ripple current for 5000 hours at 105°C , the capacitors shall meet the following requirements.	
	Capacitance change	Within ± 20% of initial value
	D.F. (tan δ)	Not more than 200% of specified value
Shelf Life	The following specifications shall be satisfied when the capacitors are restored to 20°C after exposing them for 1,000 hours at 105°C without voltage applied. Before the measurement, the capacitor shall be preconditioned by applying voltage according to item 4.1 of JIS C 5101-4.	

Dimensions [mm]

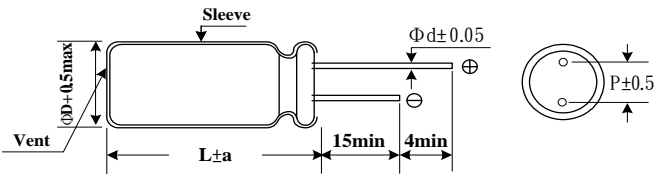

ΦD	8.0	10	12.5	13	16	18	22
P	3.5	5.0	5.0	5.0	7.5	7.5	10.0
Φd	0.6	0.6	0.6	0.6	0.8	0.8	1.0
a	1.5(2.0)	1.5(2.0)	2.0(2.5)	2.0	2.0	2.0	2.0

Notes : () : L ≥ 30mm

Multiplier for Ripple Current

Freq. (Hz)	50,60	120	300	1K	10K~100K
160~450V	0.80	1.00	1.20	1.40	1.60
500V	0.75	1.00	1.20	1.35	1.50

Jamicon Series : TJ

Teapo Series : SG

■STANDARD RATINGS

Rated Voltage (Surge Voltage) (V)	Cap (μF)	Case size ΦDxL(mm)	tan δ	Ripple current (mA/rms105°C) (120Hz)	Rated Voltage (Surge Voltage) (V)	Cap (μF)	Case size ΦDxL(mm)	tan δ	Ripple current (mA/rms105°C) (120Hz)	
160 (200)	22	10x20	0.15	160	350 (400)	68	16x32 18x25	0.2	400 380	
	33	10x20	0.15	210		82	12.5x50	0.2	450	
	47	13x20	0.15	260		100	12.5x55	0.2	500	
	68	13x25	0.15	360			18x32	0.2	530	
		16x20	0.15	430		400 (450)	4.7	※10x16	0.24	60
	100	16x25	0.15	475			6.8	※10x16	0.24	72
		18x20	0.15	465			10	※10x16	0.24	85
	150	16x32	0.15	650				10x20	0.24	100
		18x25	0.15	625			15	8x35	0.24	110
	220	16x32	0.15	750			22	8x40	0.24	140
18x25		0.15	725	13x20	0.24			145		
330	18x25	0.15	960	13x25	0.24			170		
	16x20	0.15	430	27	16x20			0.24	200	
200 (250)	10	※10x16	0.15		80		8x45	0.24	165	
	15	※10x16	0.15	100	10x35	0.24	165			
	22	10x20	0.15	160	33	8x50	0.24	190		
	33	※10x20	0.15	160		10x40	0.24	260		
		13x20	0.15	210		16x25	0.24	260		
	47	13x20	0.15	260	18x20	0.24	280			
	68	13x25	0.15	360	39	10x45	0.24	300		
		16x20	0.15	430		47	10x50	0.24	330	
	100	16x25	0.15	475	12.5x40		0.24	350		
		18x20	0.15	465	16x25		0.24	310		
150	18x25	0.15	650	16x32	0.24		345			
	220	18x32	0.15	780	18x25		0.24	360		
250 (300)	10	※10x16	0.15	85	56		12.5x45	0.24	365	
		10x20	0.15	100		68	12.5x50	0.24	420	
	22	8x30	0.15	130	16x30		0.24	340		
		※10x25	0.15	145	16x32		0.24	350		
	27	13x20	0.15	160	18x36		0.24	420		
		8x32	0.15	150	82	12.5x55	0.24	435		
	33	8x35	0.15	170		100	18x32	0.24	465	
		13x20	0.15	210	18x40		0.24	545		
	39	8x42	0.15	200	150	18x40	0.24	600		
		8x45	0.15	220		22x40	0.24	750		
	47	13x25	0.15	270	420 (470)	15	8x35	0.24	105	
		16x20	0.15	275		22	8x40	0.24	135	
	56	10x42	0.15	300		27	8x45	0.24	155	
		10x45	0.15	330			10x35	0.24	155	
	68	16x25	0.15	380		33	8x50	0.24	185	
		18x20	0.15	375			10x40	0.24	185	
	82	10x50	0.15	390		39	10x45	0.24	215	
		12.5x42	0.15	440			12.5x35	0.24	215	
	100	16x32	0.15	520		47	10x50	0.24	245	
		18x25	0.15	500			12.5x40	0.24	245	
120	12.5x45	0.15	490	56	12.5x45	0.24	290			
	12.5x50	0.15	560		68	12.5x50	0.24	335		
150	18x32	0.15	650	82		12.5x55	0.24	385		
	220	18x40	0.15	820	450 (500)	3.3	10x20	0.24	60	
350 (400)	10	10x20	0.20	100		4.7	13x20	0.24	80	
	15	8x35	0.20	120		6.8	※10x20	0.24	90	
	22	8x40	0.20	150		10	13x20	0.24	110	
		13x20	0.20	160			13x25	0.24	110	
	27	8x45	0.20	170		12	8x35	0.24	110	
		33	8x50	0.20			200	15	8x40	0.24
	13x25		0.20	230		22	8x45		0.24	165
	39	16x20	0.20	250			10x35	0.24	165	
		10x45	0.20	235			13x20	0.24	145	
	47	10x50	0.20	270	16x25		0.24	190		
16x25		0.20	300	18x20	0.24		200			
56	12.5x40	0.20	300	27	8x52		0.24	195		
	12.5x45	0.20	400							

※Down Size : 3000Hrs

Jamicon Series : TJ

Teapo Series : SG

■STANDARD RATINGS

Rated Voltage (SurageVoltage) (V)	Cap (μ F)	Case size Φ D \times L(mm)	tan δ	Ripple current (mA/rms105°C) (120Hz)	Rated Voltage (SurageVoltage) (V)	Cap (μ F)	Case size Φ D \times L(mm)	tan δ	Ripple current (mA/rms105°C) (120Hz)
450 (500)	27	10x40	0.24	195	450 (500)	100	22x40	0.24	580
	33	10x45	0.24	270	500 (550)	4.7	10x20	0.24	70
		12.5x35	0.24	300		6.8	13x20	0.24	100
		16x25	0.24	275		10	12.5x25	0.24	130
		16x32	0.24	315		22	16x25	0.24	225
		18x25	0.24	320			18x20	0.24	220
	39	10x50	0.24	335		33	16x32	0.24	305
		12.5x40	0.24	350			18x25	0.24	295
	47	10x52	0.24	360		47	16x36	0.24	430
		12.5x45	0.24	365			18x32	0.24	435
		16x26	0.24	310		68	18x32	0.24	530
		18x32	0.24	340			18x36	0.24	555
	56	12.5x50	0.24	380		82	18x40	0.24	640
	68	12.5x55	0.24	410			22x35	0.24	675
		18x25	0.24	360		100	22x35	0.24	745
		18x32	0.24	395		120	22x40	0.24	865
100	22x40	0.24	580	150		22x45	0.24	1020	

※Down Size : 3000Hrs

Jamicon Series : TX

Teapo Series : TX High Ripple · Low impedance Series

- Endurance: 105°C · 3000~5000hours
- Recommended Applications : High ripple current for Electronic Ballast , Power Supply...etc
- Corresponding product to RoHS



■ SPECIFICATIONS

Item	Characteristics						
Category Temperature Range	-40~+105°C			-25~+105°C			
Rated Voltage Range	160 ~ 400VDC			450VDC			
Rated Capacitance Range	10~ 330 μF			3.3~ 68 μF			
Capacitance Tolerance	± 20 % (120Hz , 20°C)			± 20 % (120Hz , 20°C)			
Leakage Current (20°C)	I=0.06CV + 10(μA) (After rated voltage applied for Z minutes)			I=0.04CV + 100(μA) (After rated voltage applied for 2 minutes)			
I : Max. leakage current (μA), C : Nominal capacitance (μF), V : Rated voltage (V)							
Dissipation Factor(MAX) (tan δ) (120Hz ,20°C)	WV	160	200	250	350	400	420~450
	tan δ	0.15	0.15	0.15	0.20	0.24	0.24
Low Temperature Stability Impedance Ratio (MAX)	WV	160	200	250	350	400	420~450
	Z (120Hz)	3	3	3	5	5	6
	Z-25°C / Z+20°C	6	6	6	6	6	-
Endurance	After applying rated voltage with rated ripple current for3000 (≥10 φ 5000) hours at 105°C , the capacitors shall meet the following requirements.						
	Capacitance change	Within ± 20% of initial value					
	D.F. (tan δ)	Not more than 200% of specified value					
	Leakage current	initial specified value or less					
Shelf Life	The following specifications shall be satisfied when the capacitors are restored to 20°C after exposing them for1,000 hours at 105°C without voltage applied. Before the measurement, the capacitor shall be preconditioned by applying voltage according to item 4.1 of JIS C 5101-4.						

■ Dimensions [mm]

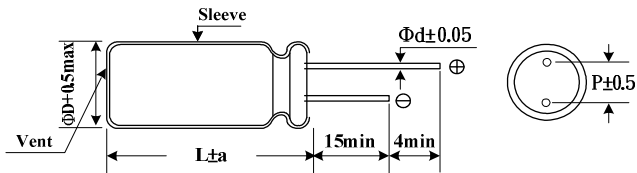

ΦD	10	12.5	16	18
P	5.0	5.0	7.5	7.5
Φd	0.6	0.6	0.8	0.8
a	1.5	2.0	2.0	2.0

Notes : () : L ≥ 30mm

■ Multiplier for Ripple Current

Freq. (Hz)	120	1k	10k	100k
160~450	0.50	0.80	0.90	1.00

Jamicon Series : TX

Teapo Series : TX

■ STANDARD RATINGS

Rated Voltage (SurageVoltage) (V)	Cap (μ F)	Case size Φ D \times L(mm)	Ripple current (mA/rms105°C) (100Hz)	Impedance (Ω ,20°C) (100KHz)	Rated Voltage (SurageVoltage) (V)	Cap (μ F)	Case size Φ D \times L(mm)	Ripple current (mA/rms105°C) (100Hz)	Impedance (Ω ,20°C) (100KHz)
160V (200)	22	10x20	350	1.47	250V (300)	150	18x32	1290	0.49
	33	10x20	430	1.15		220	18x40	1730	0.36
	47	12.5x20	550	0.92	350V (400)	10	10x20	220	1.94
	68	12.5x25	730	0.71		22	12.5x20	340	1.6
	100	16x25	890	0.59		33	12.5x25	460	1.25
	150	16x32	1210	0.41		47	16x25	560	1.00
	220	16x32	1460	0.31		68	16x32	740	0.78
330	18x36	2010	0.25	100	18x36	1010	0.65		
200V (250)	22	10x20	350	1.47	400V (450)	10	10x20	290	2.94
	33	12.5x20	460	1.15		22	12.5x25	460	1.60
	47	12.5x20	550	0.92		33	12.5x25	620	1.25
	68	12.5x25	730	0.71		47	16x25	740	1.00
	100	16x25	890	0.59		68	16x32	990	0.78
	150	16x32	1210	0.41		100	18x36	1350	0.65
	220	18x36	1640	0.31	450V (500)	3.3	10x20	150	4.47
250V (300)	10	10x20	240	3.18		4.7	12.5x20	190	3.77
	22	12.5x20	380	1.74		10	12.5x25	300	2.95
	33	12.5x25	510	1.35		22	16x25	450	1.61
	47	12.5x25	610	1.08		33	16x32	620	1.25
	68	16x25	730	0.84		47	18x32	780	1.01
	100	16x32	980	0.7		68	18x36	990	0.78

Jamicon Series : TF

Teapo Series : SP

High Ripple 、 Long life Series



- Endurance: 105°C · 8000~10000hours
- Recommended Applications : Applicable for Electronic Ballast
- Corresponding product to RoHS

■ SPECIFICATIONS

Item	Characteristics	
Category Temperature Range	-40~+105°C	-25~+105°C
Rated Voltage Range	160 ~ 450VDC	500VDC
Rated Capacitance Range	3.3 ~ 330 μF	10~ 68 μF
Capacitance Tolerance	± 20 % (120Hz , 20°C)	± 20 % (120Hz , 20°C)
Leakage Current (20°C)	I=0.04CV + 100(μ A) ,(After rated voltage applied for 2 minutes) I : Max. leakage current (μ A), C : Nominal capacitance (μ F), V : Rated voltage (V)	
Dissipation Factor(MAX) (tan δ) (120Hz ,20°C)	WV	160 200 400 420~450 500
	tan δ	0.15 0.15 0.15 0.24 0.24
Low Temperature Stability Impedance Ratio (MAX)	WV	160 200 400 420~450 500
	Z(120Hz)	
	Z-25°C / Z+20°C	3 3 5 6 6
Z-40°C / Z+20°C	4 4 6 8 -	
Endurance	The follwing sprcifications shall be satisfied when the capacitors are restored to 20°C after subjected to DC voltage with the max ripple current is applies for 10000 hours (8000 hours for φ 10) at 105°C.	
	Capacitance change	Within ± 20% of initial value
	D.F. (tan δ)	Not more than 200% of specified value
Shelf Life	The following specifications shall be satisfied when the capacitors are restored to 20°C after exposing them for 1,000 hours at 105°C without voltage applied. Before the measurement, the capacitor shall be preconditioned by applying voltage according to item 4.1 of JIS C 5101-4.	
	Leakage current	initial specified value or less

■ Dimensions [mm]

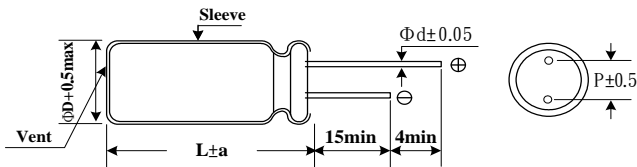

ΦD	10	12.5	13	16	18
P	5.0	5.0	7.5	7.5	7.5
Φd	0.6	0.6	0.8	0.8	0.8
a	1.5(2.0)	2(2.5)	2.0	2.0	2.0

Notes : ():L ≥ 30mm

■ Multiplier for Ripple Current

Freq. (Hz)	120	1K	10K	100K
Coefficient	1.0	1.6	1.8	2.0

Jamicon Series : TF

Teapo Series : SP

■ STANDARD RATINGS

Rated Voltage (Surage Voltage) (V)	Cap (μF)	Case size Φ D×L(mm)	Ripple current (mA/rms105°C) (120Hz)	Ripple current (mA/rms105°C) (100KHz)	Rated Voltage (Surage Voltage) (V)	Cap (μF)	Case size Φ D×L(mm)	Ripple current (mA/rms105°C) (120Hz)	Ripple current (mA/rms105°C) (100KHz)				
160 (200)	33	10x20	250	500	400(450)	68	18x32	500	1000				
	47	10x20	290	580		82	12.5x55	460	1060				
		12.5x20	330	660			16x40	550	1100				
	68	13x25	380	760	100	16x50	650	1300	420(470)	27	10x40	200	400
		16x20	380	760	100	33	10x45	235		470			
	100	13x25	485	970		39	10x50	170		340			
		16x20	560	1120		47	12.5x42	310		620			
		16x25	560	1120		56	12.5x45	330		660			
	150	18x20	560	1120	68	12.5x50	390	780		82	12.5x55	450	900
		10x45	410	820	450 (500)	3.3	10x16	50	100				
		16x25	600	1200		4.7	10x20	70	140				
		16x32	680	1360		6.8	10x20	75	150				
	18x25	680	1360	12.5x20			90	180					
	180	10x50	470	940		10	10x20	130	260				
	220	12.5x45	550	1100			12.5x20	160	320				
		16x32	700	1400		22	10x40	250	500				
		18x25	700	1400			13x20	215	430				
	270	12.5x50	640	1280			16x20	240	480				
12.5x55		740	1480	16x25			280	560					
330	18x36	690	1380	18x20		280	560						
	200 (250)	22	10x20	250		500	27	10x42	270	540			
33		10x20	260	520		33	10x45	350	600				
		12.5x20	300	600			16x32	350	700				
47		13x20	330	660		18x25	350	700					
		13x25	380	760		39	10x50	340	680				
68		16x20	380	760			12.5x40	350	700				
		100	16x25	560		1120	12.5x45	420	840				
18x20			560	1120	16x36	440	880						
120		10x50	430	860	47	18x20	350	700					
		12.5x45	510	1320		18x25	390	780					
150		16x32	680	1360		18x32	440	880					
		180	12.5x50	590		1180	18x36	440	880				
250(300)		220	12.5x52	650	1300	56	12.5x50	450	900				
		270	12.5x55	750	1500	68	12.5x55	530	1060				
		82	10x52	390	780		16x40	550	1100				
			12.5x42	470	940	82	16x45	625	1250				
		120	12.5x45	480	960		18x36	625	1250				
		150	12.5x50	540	1080	100	16x50	750	1550				
180	12.5x55	650	1300	18x40	750		1550						
350(400)	47	12.5x35	300	600	500(550)	10	12.5x20	130	260				
	68	12.5x45	400	800		15	12.5x25	165	330				
		82	12.5x50	475			950	16x20	170	340			
	100	16x40	550	1100		18	12.5x30	195	390				
6.8		10x16	110	220			16x20	185	370				
400 (450)	10	10x20	140	280		22	12.5x35	230	460				
	22	12.5x25	215	430			16x25	230	460				
		33	16x20	215		430	18x20	225	450				
	12.5x30		300	600		27	12.5x40	270	540				
	39	16x20	250	500			16x25	250	500				
		16x25	320	640		33	16x30	300	600				
	47	10x45	260	615			18x25	295	590				
		12.5x35	325	650		39	16x36	355	710				
	56	12.5x40	310	720			16x40	410	820				
		16x32	420	840		47	18x30	385	770				
	18x25	420	840	56			18x36	455	910				
	68	10x52	340	680		68	18x40	515	1030				
		12.5x45	360	720									
	68	12.5x50	450	900									

Jamicon Series : TR

Teapo Series : SU High Ripple 、 Long life Series

- Endurance : 105°C 10000~12000hours
- Recommended Applications : Electronic lighting and power
- Corresponding product to RoHS



SPECIFICATIONS

Item	Characteristics						
Category Temperature Range	-40 ~ +105°C						
Rated Voltage Range	160~450VDC						
Rated Capacitance Range	6.8 ~ 560 µF						
Capacitance Tolerance	± 20 % (120Hz , 20°C)						
Leakage Current (20°C)	I=0.04CV +100 µ A . (After rated voltage applied for 2 minutes) I : Max. leakage current (µ A), C : Nominal capacitance (µ F), V : Rated voltage (V)						
Dissipation Factor(MAX) (tan δ) (120Hz ,20°C)	WV	160	200	250	350	400	450
	tan δ	0.15	0.15	0.15	0.20	0.20	0.20
Low Temperature Stability Impedance Ratio (MAX)	WV	160	200	250	350	400	450
	Z(120Hz)	3	3	3	5	5	6
	Z-25°C / Z+20°C	6	6	6	6	6	8
Endurance	After applying rated voltage with rated ripple current for 10000~12000hours at 105°C, the capacitors shall meet the following requirements.						
	Capacitance change	Within ± 20% of initial value				ΦD×L	Life time (hours)
	D.F. (tan δ)	Not more than 200% of specified value				10 Φ	10000
Shelf Life	Leakage current	initial specified value or less				≥ 13 Φ	12000
	The following specifications shall be satisfied when the capacitors are restored to 20°C after exposing them for 1,000 hours at 105°C without voltage applied. Before the measurement, the capacitor shall be preconditioned by applying voltage according to item 4.1 of JIS C 5101-4.						

Dimensions [mm]

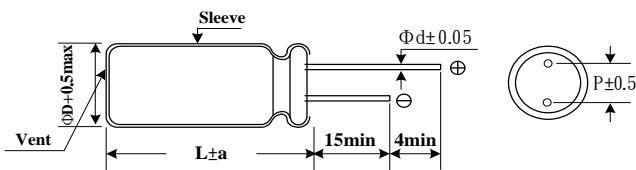

ΦD	10.0	13.0	16.0	18.0
P	5.0	5.0	7.5	7.5
Φd	0.6	0.6	0.8	0.8
a	1.5	2.0	2.0	2.0

Multiplier for Ripple Current

Multiplier for Ripple Current	120	1K	10K	100K
coefficient	0.5	0.8	0.9	1.0

Jamicon Series : TR

Teapo Series : SU

■ STANDARD RATINGS

Rated Voltage (SurageVoltage) (V)	Cap (μ F)	Case size Φ D \times L(mm)	$\tan \delta$	Ripple current (mA/rms105°C) (100KHz)	Rated Voltage (SurageVoltage) (V)	Cap (μ F)	Case size Φ D \times L(mm)	$\tan \delta$	Ripple current (mA/rms105°C) (100KHz)
160 (200)	33	10x16	0.15	500	350(400)	22	13x20	0.20	650
	47	10x20	0.15	580		33	13x25	0.20	900
	68	13x20	0.15	720		47	16x25	0.20	1000
	100	13x25	0.15	970		68	16x32	0.20	1100
	150	16x25	0.15	1120		400 (450)	6.8	10x16	0.20
	220	16x32	0.15	1300	10		10x20	0.20	180
	330	18x36	0.15	1380	18		10x20	0.20	220
560	18x50	0.15	2086	22	13x20		0.20	430	
200 (250)	22	10x16	0.15	500	33		16x20	0.20	450
	33	10x20	0.15	520	47		16x25	0.20	520
	47	13x20	0.15	660	68		16x32	0.20	700
	68	13x25	0.15	720	100	18x32	0.20	870	
	100	16x25	0.15	1120	100	18x50	0.20	1290	
	150	16x32	0.15	1620	450 (500)	4.7	10x16	0.20	110
	220	18x32	0.15	2080		10	10x20	0.20	180
390	18x50	0.15	3380	10		13x16	0.20	180	
250(300)	10	10x16	0.15	320		15	13x20	0.20	380
	22	10x20	0.15	500		22	13x20	0.20	430
	33	13x20	0.15	800		22	13x25	0.20	500
	47	13x20	0.15	980		22	16x20	0.20	500
	100	16x25	0.15	1530		33	16x25	0.20	560
	150	18x25	0.15	1940		47	16x25	0.20	650
	220	18x36	0.15	2753		47	16x36	0.20	880
330	18x50	0.15	3912	68	16x36	0.20	1110		
350(400)	6.8	10x16	0.20	280	100	18x50	0.20	1560	
	10	10x20	0.20	350					
		13x20	0.20	450					

Jamicon Series : TS

Teapo Series : TS

High Ripple 、 Long life Series

- Endurance : 105°C 15000~20000hours
- Recommended Applications : Electronic lighting and power
- Corresponding product to RoHS



SPECIFICATIONS

Item	Characteristics						
Category Temperature Range	-40 ~ +105°C						
Rated Voltage Range	160~450VDC						
Rated Capacitance Range	6.8 ~ 220 μF						
Capacitance Tolerance	± 20 % (120Hz , 20°C)						
Leakage Current (20°C)	I=0.04CV +100 μ A . (After rated voltage applied for 2 minutes) I : Max. leakage current (μ A), C : Nominal capacitance (μ F), V : Rated voltage (V)						
Dissipation Factor(MAX) (tan δ) (120Hz ,20°C)	WV	160	200	250	350	400	450
	tan δ	0.15	0.15	0.15	0.20	0.20	0.20
Low Temperature Stability Impedance Ratio (MAX)	Z(120Hz)	160	200	250	350	400	450
	Z-25°C / Z+20°C	3	3	3	5	5	6
	Z-40°C / Z+20°C	6	6	6	6	6	8
Endurance	After applying rated voltage with rated ripple current for 20000hours (10*12.5=15000Hrs) at 105°C, the capacitors shall meet the following requirements.						
	Capacitance change	Within ± 30% of initial value					
	D.F. (tan δ)	Not more than 300% of specified value					
Shelf Life	The following specifications shall be satisfied when the capacitors are restored to 20°C after exposing them for 1,000 hours at 105°C without voltage applied. Before the measurement, the capacitor shall be preconditioned by applying voltage according to item 4.1 of JIS C 5101-4.						
	Leakage current						

Dimensions [mm]

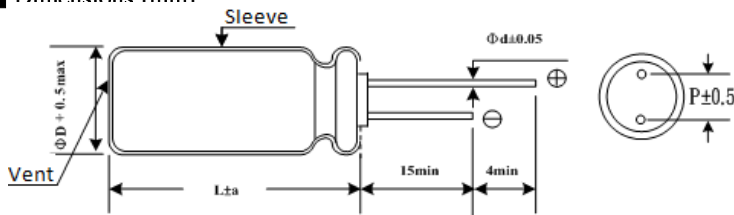

ΦD	10.0	13.0	16.0	18.0
P	5.0	5.0	7.5	7.5
Φd	0.6	0.6	0.8	0.8
a	1.5	2.0	2.0	2.0

Multiplier for Ripple Current

Multiplier for Ripple Current	120	1K	10K	100K
coefficient	1.00	1.75	2.25	2.50

Jamicon Series : TS

Teapo Series : TS

■ STANDARD RATINGS

Rated Voltage (SurageVoltage) (V)	Cap (μ F)	Case size Φ DxL(mm)	$\tan \delta$	Ripple current (mA/rms105°C) (120Hz)	Rated Voltage (SurageVoltage) (V)	Cap (μ F)	Case size Φ DxL(mm)	$\tan \delta$	Ripple current (mA/rms105°C) (120Hz)
160 (200)	22	10x12.5	0.15	121	350(400)	6.8	10x12.5	0.20	80
	33	10x16	0.15	158		10	10x16	0.20	107
	47	10x20	0.15	204		22	13x20	0.20	204
	68	13x20	0.15	284		33	16x20	0.20	281
	100	16x20	0.15	388		47	16x25	0.20	369
	220	18x32	0.15	715		68	18x25	0.20	475
200 (250)	22	10x16	0.15	138	400 (450)	6.8	10x16	0.20	80
	33	10x20	0.15	187		10	10x20	0.20	106
	47	13x20	0.15	259		22	16x20	0.20	207
	68	16x20	0.15	351		33	16x25	0.20	279
	100	16x25	0.15	468		47	16x32	0.20	371
	150	18x32	0.15	613		68	18x25	0.20	476
250(300)	10	10x12.5	0.15	90	450 (500)	10	10x20	0.20	92
	22	10x20	0.15	162		22	13x25	0.20	240
	33	13x20	0.15	229		33	16x25	0.20	368
	47	16x20	0.15	309		47	18x25	0.20	480
	100	18x25	0.15	530		68	18x32	0.20	520

Jamicon Series : WB

Teapo Series : AK

High Temperature · Ultra Long Life Series



- Endurance: 125°C 2000~5000hrs
- Recommended Applications :Applicable for Electronic Ballast,Lighting Ballast
- Corresponding product to RoHS

■ SPECIFICATIONS

Item	Characteristics	
Category Temperature Range	-40 ~ +125°C	-25 ~ +125°C
Rated Voltage Range	10~63VDC	160~450VDC
Rated Capacitance Range	47~ 4700 μF	1~150 μF
Capacitance Tolerance	± 20 % (120Hz , 20°C)	
Leakage Current (20°C)	I=0.01CV or 3(μA)whichever is greater.	I=0.1CV+40 uA (CV ≤ 1000)
		I=0.04CV+100 uA (CV>1000)
(After rated voltage applied for 2 minutes) I : Max. leakage current (μA), C : Nominal capacitance (μF), V : Rated voltage (V)		
Dissipation Factor(MAX) (tan δ) (120Hz ,20°C)	WV	10 16 25 35 50 63 160~250 350~450
	tan δ	0.19 0.16 0.14 0.12 0.14 0.14 0.20 0.24
When nominal capacitance is over 1000uF,tan δ shall be added 0.02 to the listed value with increase of every 1000uF. Down Size tan δ added 0.03.		
Low Temperature Stability Impedance Ratio (MAX)	WV	10 16 25 35 50 63 160~250 350~450
	Z(120Hz)	
	Z-25°C / Z+20°C	3 2 2 2 2 2 3 6
	Z-40°C / Z+20°C	6 4 4 4 4 3 — —
Endurance	After applying rated voltage with rated ripple current for 2000~5000 hours at125°C , the capacitors shall meet the following requirements.	
	Rated Voltage Range	10~63VDC 160~450VDC
	Capacitance Change	Within ± 30 % of initial value Within ± 20 % of initial value
	Dissipation Factor	≤ 300% of initial specified value ≤ 200% of the initial specified value
	Leakage Current	≤ initial specified value or less ≤ initial specified value
	D Φ	≤ 8 Φ ,10 Φ L<15mm 10 Φ L ≥ 15mm ≥ 13 Φ
Life	2000Hrs 3000Hrs 5000Hrs	
Shelf Life	The following specifications shall be satisfied when the capacitors are restored to 20°C after exposing them for1,000 hours at 125°C without voltage applied. Before the measurement, the capacitor shall be preconditioned by applying voltage according to item 4.1 of JIS C 5101-4.	
	Rated Voltage Range	10~63VDC 160~450VDC
	Capacitance Change	Within ± 30 % of initial value Within ± 20 % of initial value
	Dissipation Factor	≤ 300% of initial specified value ≤ 200% of the initial specified value
	Leakage Current	≤ 500% of initial specified value ≤ 500% of the initial specified value

■ Dimensions [mm]

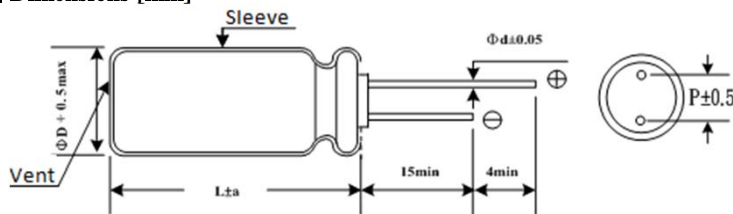

ΦD	8	10	13	16	18
P	3.5	5.0	5.0	7.5	7.5
Φd	0.6	0.6	0.6	0.8	0.8
a	1.5	1.5	2.0	2.0	2.0

■ Multiplier for Ripple Current

Freq. (Hz)		120	1K	10K	50K~100K
10~63WV	CAP ≤ 10	0.40	0.75	0.90	1.00
	10<CAP ≤ 100	0.50	0.85	0.95	1.00
	100<CAP ≤ 1000	0.60	0.88	0.96	1.00
	1000<CAP	0.75	0.90	0.98	1.00
160~450WV	CAP ≤ 33	1.00	1.50	1.75	1.80
	CAP ≥ 47	1.00	1.30	1.40	1.50

Jamicon Series : WB

Teapo Series : AK

■ STANDARD RATINGS

Rated Voltage (SurageVoltage) (V)	Cap (μF)	Case size ΦDxL(mm)	tan δ	Ripple current (mA/rms125°C) (100KHz)
10(13)	47	6.3x11	0.19	80
	100	6.3x11	0.19	150
	220	8x11	0.19	340
	330	10x12.5	0.19	500
	470	10x16	0.19	630
	1000	10x20	0.19	770
	2200	13x25	0.21	1250
	3300	16x25	0.23	1380
16(20)	4700	16x32	0.25	1450
	33	6.3x11	0.16	75
	47	6.3x11	0.16	90
	100	8x11	0.16	170
	220	8x11	0.16	340
	330	10x12.5	0.16	500
	470	10x20	0.16	770
	1000	13x20	0.16	920
25(32)	2200	16x25	0.18	1380
	3300	16x32	0.20	1450
	4700	16x32	0.22	1720
	22	6.3x11	0.14	70
	33	8x11	0.14	110
	47	8x11	0.14	130
	100	8x11	0.14	340
	220	10x12.5	0.14	500
	330	10x16	0.14	630

Rated Voltage (SurageVoltage) (V)	Cap (μF)	Case size ΦDxL(mm)	tan δ	Ripple current (mA/rms125°C) (100KHz)
25(32)	470	10x20	0.14	770
	1000	13x25	0.14	1250
	2200	16x32	0.16	1450
35(44)	22	8x11	0.14	100
	33	8x11	0.14	120
	47	8x11	0.14	140
	100	10x12.5	0.12	340
	220	10x16	0.12	500
	330	10x20	0.12	770
	470	13x20	0.12	920
	1000	16x25	0.12	1380
50(63)	10	8x11	0.14	70
	22	8x11	0.14	110
	33	8x11	0.14	130
	47	8x11	0.14	245
	100	10x12.5	0.14	415
	220	10x20	0.14	491
	330	13x20	0.14	665
	470	13x25	0.14	995
	1000	16x32	0.14	1280
	63(79)	47	8x11	0.14
100		10x15	0.14	455
220		13x20	0.14	665
330		13x25	0.14	995
470		16x25	0.14	1000

Rated Voltage (SurageVoltage) (V)	Cap (μF)	Case size ΦDxL(mm)	tan δ	Ripple current (mA/rms125°C) (120Hz)
160(200)	3.3	8x11	0.20	28
	4.7	10x12.5	0.20	40
	10	10x16	0.20	60
	22	10 x 20	0.20	115
	33	10 x 25	0.20	154
	47	13 x 20	0.20	187
	68	13 x 25	0.20	245
	100	16 x 25	0.20	329
	150	16 x 32	0.20	434
200(250)	3.3	8x11	0.20	28
	4.7	10x12.5	0.20	40
	10	10 x 20	0.20	78
	22	10 x 25	0.20	126
	33	13 x 20	0.20	157
	47	13 x 25	0.20	204
	68	16 x 20	0.20	250
250(300)	100	16 x 25	0.20	329
	2.2	8x11	0.20	28
	3.3	10x12.5	0.20	32
	4.7	10x16	0.20	45
	10	10 x 20	0.20	78
	22	13 x 20	0.20	128
	33	13 x 25	0.20	171
	47	16 x 25	0.20	225
	68	16 x 32	0.20	292

Rated Voltage (SurageVoltage) (V)	Cap (μF)	Case size ΦDxL(mm)	tan δ	Ripple current (mA/rms125°C) (120Hz)
350(400)	1.0	8x11	0.24	25
	2.2	10x12.5	0.24	32
	3.3	10x16	0.24	45
	4.7	10 x 20	0.24	53
	10	10 x 25	0.24	85
	22	13 x 25	0.24	139
	33	16 x 25	0.24	189
	47	16 x 32	0.24	243
	400(450)	1.0	10x12.5	0.24
2.2		10x16	0.24	35
3.3		10x16	0.24	42
4.7		10 x 20	0.24	53
10		10 x 25	0.24	86
22		13 x 30	0.24	142
33		16 x 25	0.24	189
450(500)	47	16 x 32	0.24	243
	1.0	8x16	0.24	25
	2.2	10x16	0.24	32
	3.3	10x20	0.24	40
	4.7	10 x 25	0.24	58
	10	13 x 20	0.24	86
	22	16 x 25	0.24	154
	33	16 x 32	0.24	203

Jamicon Series : WF

Teapo Series : AR

High Temperature · Low impedance · Ultra Long Life Series

- Endurance: 125°C 3000~5000hrs
- Recommended Applications : Applicable for Electronic Ballast,Lighting Ballast
- Corresponding product to RoHS

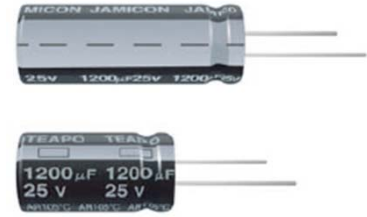

■ SPECIFICATIONS

Item	Characteristics				
Category Temperature Range	-40 ~ +125°C				
Rated Voltage Range	25~63VDC				
Rated Capacitance Range	470~ 6800 µF				
Capacitance Tolerance	± 20 % (120Hz , 20°C)				
Leakage Current (20°C)	I=0.03CV or 4(µA)whichever is greater. (After rated voltage applied for 1 minutes) I : Max. leakage current (µA), C : Nominal capacitance (µF), V : Rated voltage (V)				
Dissipation Factor(MAX) (tan δ) (120Hz ,20°C)	WV	25	35	50	63
	tan δ	0.14	0.12	0.14	0.14
When nominal capacitance is over 1000 µF,tan δ shall be added 0.02 to the listed value with increase of every 1000 µF.					
Low Temperature Stability Impedance Ratio (MAX)	WV	25	35	50	63
	Z(120Hz)				
	Z-25°C / Z+20°C	2	2	2	2
	Z-40°C / Z+20°C	4	4	4	4
Endurance	After applying rated voltage with rated ripple current for 3000~5000 hours at 125°C, the capacitors shall meet the following requirements.				
	Rated Voltage Range	25~63VDC			
	Capacitance change	Within ±30% of initial value			
	D.F. (tan δ)	Not more than300% of specified value			
	Leakage current	initial specified value or less			
	L(height)	L ≤ 20mm		L ≥ 25mm	
Life	3000Hrs		5000Hrs		
Shelf Life	The following specifications shall be satisfied when the capacitors are restored to 20°C after exposing them for1,000 hours at 125°C without voltage applied. Before the measurement, the capacitor shall be preconditioned by applying voltage according to item 4.1 of JIS C 5101-4.				
	Rated Voltage Range	25~63VDC			
	Capacitance change	Within ±30% of initial value			
	D.F. (tan δ)	Not more than300% of specified value			
	Leakage current	initial specified value or less			

■ Dimensions [mm]

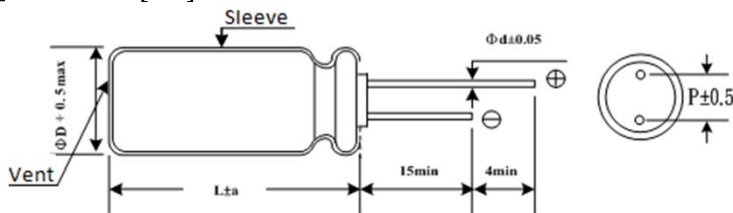

ΦD	13	16	18
P	5.0	7.5	7.5
Φd	0.6	0.8	0.8
a	2.0	2.0	2.0

■ Multiplier for Ripple Current

Freq. (Hz)		120	1K	10K	100K
25~63WV	CAP:470~560 µF	0.50	0.85	0.94	1.00
	CAP:620~1800 µF	0.60	0.87	0.95	1.00
	CAP:2200~3900 µF	0.75	0.90	0.95	1.00
	CAP:4700~6800 µF	0.85	0.95	0.98	1.00

Jamicon Series : WF

Teapo Series : AR

■ STANDARD RATINGS

Rated Voltage (SurageVoltage) (V)	Cap (μ F)	Case size Φ D \times L(mm)	Ripple current (mA/rms125°C) (100KHz)	Impedance (Ω ,20°C) (100KHz)	Rated Voltage (SurageVoltage) (V)	Cap (μ F)	Case size Φ D \times L(mm)	Ripple current (mA/rms125°C) (100KHz)	Impedance (Ω ,20°C) (100KHz)
25(32)	1200	13x20	1820	0.046	35(44)	3300	18x36	3840	0.020
	1800	13x25	2280	0.040		4700	18x40	4230	0.017
	2200	16x20	2280	0.036	50(63)	470	13x20	1500	0.095
		13x30	2560	0.031		680	13x25	1900	0.078
	2700	13x35	2970	0.027		16x20	2040	0.073	
		16x25	2860	0.028		820	13x30	2150	0.071
		18x20	2490	0.036		1000	13x35	2510	0.064
	3300	13x40	3340	0.023			16x25	2620	0.061
		16x30	3160	0.025			18x20	2240	0.069
	3900	16x36	3590	0.022		1200	13x40	2870	0.058
		18x25	3010	0.026			16x30	2940	0.057
	4700	18x30	3390	0.022		18x25	2750	0.059	
		5600	16x40	3970		0.018	1500	16x36	3300
	6800		18x36	3840		0.020	1800	18x30	3140
35(44)		680	13x20	1820		0.046	2200	16x40	3720
	1000	13x25	2280	0.040		18x36	3510	0.052	
	1200	13x30	2560	0.031	2700	18x40	3940	0.048	
		16x20	2280	0.036	63(79)	470	16x20	1790	0.105
	1500	13x35	2970	0.027		680	16x25	2030	0.085
		18x20	2490	0.036		820	18x20	1910	0.095
	1800	13x40	3340	0.023		820	16x30	2330	0.073
		16x25	2860	0.028		1000	16x36	2580	0.064
	2200	16x30	3160	0.025			18x25	2280	0.069
		2700	18x25	3010		0.026	1200	16x40	2900
	3300		16x36	3590		0.022	18x30	2580	0.061
		3900	18x30	3390		0.022	1500	18x36	2890
	4230		18x40	4230		0.017	1800	18x40	3210

Jamicon Series : WH

Teapo Series : AT

High Temperature · Ultra Long Life Series

- Endurance: 130°C 1000~4000hours
- Recommended Applications : Applicable for Electronic Ballast,Lighting Ballast
- Corresponding product to RoHS



SPECIFICATIONS

Item	Characteristics						
Category Temperature Range	-40 ~ +130°C						
Rated Voltage Range	10~63VDC						
Rated Capacitance Range	22~ 4700 μF						
Capacitance Tolerance	± 20 % (120Hz , 20°C)						
Leakage Current (20°C)	I=0.03CV or 4(μA)whichever is greater. (After rated voltage applied for 1 minutes) I : Max. leakage current (μA), C : Nominal capacitance (μF), V : Rated voltage (V)						
Dissipation Factor(MAX) (tan δ) (120Hz , 20°C)	WV	10	16	25	35	50	63
	tan δ	0.20	0.16	0.14	0.12	0.10	0.09
When nominal capacitance is over 1000 μF,tan δ shall be added 0.02 to the listed value with increase of every 1000 μF.							
Low Temperature Stability Impedance Ratio (MAX)	WV	10	16	25	35	50	63
	Z(120Hz)						
	Z-25°C / Z+20°C	3	2	2	2	2	2
	Z-40°C / Z+20°C	6	4	4	4	4	4
Endurance	After applying rated voltage with rated ripple current for 1000~4000 hours at 130°C , when the capacitors are restored to 20°C , the capacitors shall meet the following requirements.						
	Rated Voltage Range	10~63VDC					
	Capacitance change	Within ±30% of initial value					
	D.F. (tan δ)	Not more than300% of specified value					
	Leakage current	initial specified value or less					
	DΦ	5~6.3Φ	8~10Φ	≥12.5Φ			
Life(hours)	1000	2000	4000				
Shelf Life	The following specifications shall be satisfied when the capacitors are restored to 20°C after exposing them for1,000 hours at 130°C without voltage applied. Before the measurement, the capacitor shall be preconditioned by applying voltage according to item 4.1 of JIS C 5101-4.						
	Rated Voltage Range	10~63VDC					
	Capacitance change	Within ±30% of initial value					
	D.F. (tan δ)	Not more than300% of specified value					
	Leakage current	initial specified value or less					

Dimensions [mm]

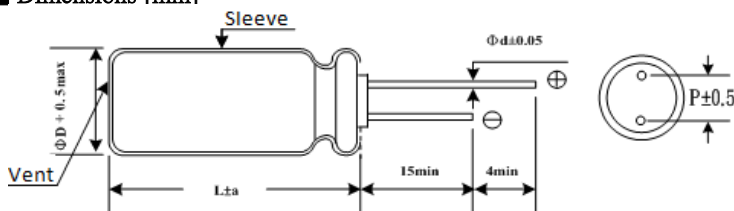

ΦD	5	6.3	8	10	12.5	16	18
P	2.0	2.5	3.5	5.0	5.0	7.5	7.5
Φd	0.5	0.5	0.6	0.6	0.6	0.8	0.8
a	1.5	1.5	1.5	1.5	2.0	2.0	2.0

Multiplier for Ripple Current

Freq. (Hz)		120	1K	10K	≥100K
10~63WV	CAP:22~47 μF	0.55	0.75	0.90	1.00
	CAP:68~330 μF	0.70	0.85	0.95	1.00
	CAP:470~1500 μF	0.75	0.90	0.98	1.00
	CAP:2200~4700 μF	0.80	0.95	1.00	1.00

Jamicon Series : WH

Teapo Series : AT

■ STANDARD RATINGS

Rated Voltage (SurageVoltage) (V)	Cap (μ F)	Case size Φ DxL(mm)	$\tan \delta$	Ripple current (mA/rms130°C) (100KHz)	Rated Voltage (SurageVoltage) (V)	Cap (μ F)	Case size Φ DxL(mm)	$\tan \delta$	Ripple current (mA/rms130°C) (100KHz)
10(13)	330	8x11	0.20	360	35(44)	470	10x20	0.12	960
	470	10x12.5	0.20	620		1000	12.5x25	0.12	1430
	1000	10x20	0.20	960		2200	16x35	0.14	2550
	2200	12.5x25	0.22	1430		3300	18x35	0.16	2800
	3300	16x25	0.24	1900		50(63)	22	5x11	0.10
	4700	16x30	0.26	2300	33		6.3x11	0.10	250
16(20)	330	8x11	0.16	360	47		8x11	0.10	300
	470	10x12.5	0.16	620	100		6.3x12	0.10	260
	1000	10x20	0.16	960	220		10x20	0.10	890
	2200	12.5x25	0.18	1430	330		12.5x20	0.10	1000
	3300	16x30	0.20	2300	470		12.5x25	0.10	1200
	4700	16x35	0.22	2550	1000		16x30	0.10	2180
25(32)	47	5x11	0.14	130	2200		18x40	0.12	2800
	68	6.3x11	0.14	170	63(79)		33	8x11	0.09
	220	8x11	0.14	360		47	10x12.5	0.09	400
	330	10x12.5	0.14	620		100	10x16	0.09	450
	470	10x20	0.14	800		220	12.5x20	0.09	820
	1000	12.5x25	0.14	1100		330	12.5x25	0.09	1000
	2200	16x30	0.16	2300		470	16x25	0.09	1500
	3300	16x35	0.18	2500		1000	16x30	0.09	1850
35(44)	100	8x11	0.12	360		1500	18x40	0.09	2350
	220	10x12.5	0.12	620					
	330	10x16	0.12	800					

Jamicon Series : AU

Teapo Series : AU

High Temperature · Ultra Long Life Series

- Endurance: 135°C 1000~3000小时
- Recommended Applications : Applicable for Electronic Ballast,Lighting Ballast
- Corresponding product to RoHS

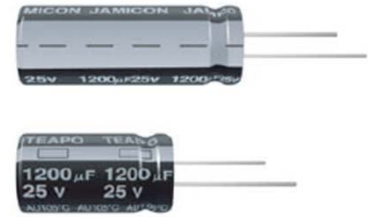

■ SPECIFICATIONS

Item	Characteristics						
Category Temperature Range	-40 ~ +135°C						
Rated Voltage Range	10~63VDC						
Rated Capacitance Range	22~ 4700 µ F						
Capacitance Tolerance	± 20 % (120Hz , 20°C)						
Leakage Current (20°C)	I=0.03CV or 4(µ A)whichever is greater. (After rated voltage applied for 1 minutes) I : Max. leakage current (µ A), C : Nominal capacitance (µ F), V : Rated voltage (V)						
Dissipation Factor(MAX) (tan δ) (120Hz ,20°C)	WV	10	16	25	35	50	63
	tan δ	0.20	0.16	0.14	0.12	0.10	0.09
When nominal capacitance is over 1000 µ F,tan δ shall be added 0.02 to the listed value with increase of every 1000 µ F.							
Low Temperature Stability Impedance Ratio (MAX)	WV	10	16	25	35	50	63
	Z(120Hz)						
	Z-25°C / Z+20°C	3	2	2	2	2	2
	Z-40°C / Z+20°C	6	4	4	4	4	4
Endurance	After applying rated voltage with rated ripple current for 1000~3000 hours at 135°C, the capacitors shall meet the following requirements.						
	Rated Voltage Range	10~63VDC					
	Capacitance change	Within ±30% of initial value					
	D.F. (tan δ)	Not more than300% of specified value					
	Leakage current	initial specified value or less					
	DΦ	8Φ	10Φ	≥12.5Φ			
Life(hours)	1000	2000	3000				
Shelf Life	The following specifications shall be satisfied when the capacitors are restored to 20°C after exposing them for1,000 hours at 130°C without voltage applied. Before the measurement, the capacitor shall be preconditioned by applying voltage according to item 4.1 of JIS C 5101-4.						
	Rated Voltage Range	10~63VDC					
	Capacitance change	Within ±30% of initial value					
	D.F. (tan δ)	Not more than300% of specified value					
	Leakage current	initial specified value or less					

■ Dimensions [mm]

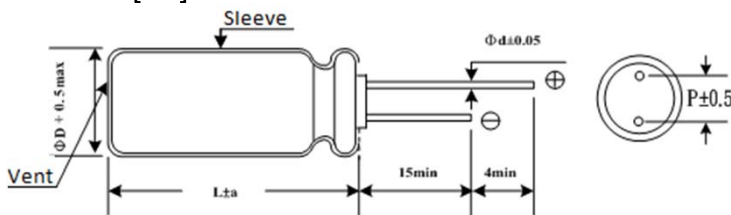

ΦD	5	6.3	8	10	12.5	16	18
P	2.0	2.5	3.5	5.0	5.0	7.5	7.5
Φd	0.5	0.5	0.6	0.6	0.6	0.8	0.8
a	1.5	1.5	1.5	1.5	2.0	2.0	2.0

■ Multiplier for Ripple Current

Freq. (Hz)		120	1K	10K	≥100K
10~63WV	CAP:<100µ F	0.40	0.75	0.90	1.00
	CAP:100~470µ F	0.50	0.85	0.94	1.00
	CAP:>470µ F	0.60	0.87	0.95	1.00

Jamicon Series : AU

Teapo Series : AU

■STANDARD RATINGS

Rated Voltage (SurageVoltage) (V)	Cap (μ F)	Case size Φ D \times L(mm)	tan δ	Ripple current (mA/rms135°C) (100KHz)	Rated Voltage (SurageVoltage) (V)	Cap (μ F)	Case size Φ D \times L(mm)	tan δ	Ripple current (mA/rms135°C) (100KHz)
10(13)	220	8x11	0.20	340	35(44)	100	10x12	0.12	620
	330	10x12	0.20	490		220	10x16	0.12	790
	470	10x15	0.20	640		330	10x20	0.12	950
	1000	10x20	0.20	1060		470	12.5x20	0.12	1330
	2200	12.5x25	0.24	1750		1000	16x25	0.12	2010
	3300	16x25	0.26	2300	50(63)	33	8x11	0.10	300
	4700	16x32	0.28	2710		47	8x11	0.10	440
16(20)	100	8x11	0.16	340		100	10x12	0.10	555
	220	10x12	0.16	595		220	10x20	0.10	930
	330	10x15	0.16	680		330	12.5x20	0.10	1330
	470	10x16	0.16	945		470	12.5x25	0.10	1650
	1000	12.5x20	0.16	1490	1000	16x32	0.10	2340	
	2200	16x25	0.20	2300	63(79)	22	8x11	0.09	130
3300	16x32	0.22	2710	33		8x11	0.09	150	
25(32)	100	8x11	0.14	500		47	10x12	0.09	230
	220	10x12	0.14	680		100	10x16	0.09	370
	330	10x16	0.14	945		220	12.5x20	0.09	685
	470	10x20	0.14	1100		330	12.5x25	0.09	925
	1000	12.5x25	0.14	1750		470	12.5x35	0.09	1280
	2200	16x32	0.18	2710		1000	16x32	0.09	2060

Jamicon Series : NK

Teapo Series : RN

Non-polar Standard Serie

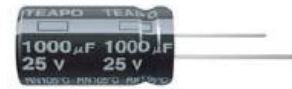

- Endurance: 85°C,2000hours, Non-polarized/Polarity reversing
- Recommended Applications :Small crossover network, Reversed polarity circuit, Coupling
- Corresponding product to RoHS

■ SPECIFICATIONS

Item	Characteristics	
Category Temperature Range	-40 ~ +85°C	-25~+85°C
Rated Voltage Range	6.3~ 100VDC	160~250VDC
Rated Capacitance Range	1 ~ 6800 μF	1~100 μF
Capacitance Tolerance	± 20 % (120Hz , 20°C)	
Leakage Current (20°C)	I ≤ 0.03CV+4 μ A ; L=7mm,I ≤ 0.05CV or 10 μ A whichever is greater. (After rated voltage applied for 2 minutes) I : Max. leakage current (μ A), C : Nominal capacitance (μ F), V : Rated voltage (V)	
Dissipation Factor(MAX) (tan δ) (120Hz ,20°C)	WV	6.3 10 16 25 35 50 63~100 160~250
	tan δ	0.24 0.2 0.17 0.15 0.15 0.15 0.12 0.20
When nominal capacitance is over 1000 μ F,tan δ shall be added 0.02 to the listed value with increase of every 1000 μ F.		
Low Temperature Stability Impedance Ratio (MAX)	Z(120Hz)	6.3 10 16 25 35 50 63~100 160~250
	Z(-25°C) / Z(+20°C)	4 3 2 2 2 2 2 6
	Z(-40°C) / Z(+20°C)	8 6 4 4 3 3 3 -
Endurance	After applying rated voltage with rated ripple current for2000 (L≤7mm1000) hours at 85°C, the capacitors shall meet the following requirements.	
	Capacitance change	Within ± 20% of initial value
	D.F. (tan δ)	Not more than 200% of specified value
Shelf Life	The following specifications shall be satisfied when the capacitors are restored to 20°C after exposing them for500 hours at 85°C without voltage applied. Before the measurement, the capacitor shall be preconditioned by applying voltage according to item 4.1 of JIS C 5101-4.	
	Leakage current	Not more than the specified value

■ Dimensions [mm]

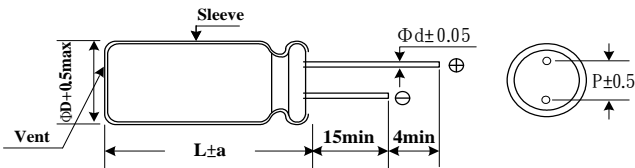

ΦD	4	5	6.3	8	10	13	16	18
P	1.5	2.0	2.5	3.5	5.0	5.0	7.5	7.5
Φd	0.45	0.5(0.45)	0.5(0.45)	0.6	0.6	0.6	0.8	0.8
a	1.0	1.5(1.0)	1.5(1.0)	1.5	1.5	2.0	2.0	2.0

() : L = 7

■ Multiplier for Ripple Current

Freq. (Hz)	50	120	1K	10K
WV(VDC)				
6.3 ~ 16V	0.8	1.0	1.1	1.2
25 ~ 35V	0.8	1.0	1.5	1.7
50 ~ 100V	0.8	1.0	1.6	1.9
160 ~ 250V	0.8	1.0	1.5	1.6

Jamicon Series : NK

Teapo Series : RN

■ STANDARD RATINGS

Rated Voltage (Surge Voltage) (V)	Cap (μF)	Case size Φ D×L(mm)	tan δ	Ripple current (mA/rms85°C) (120Hz)	Rated Voltage (Surge Voltage) (V)	Cap (μF)	Case size Φ D×L(mm)	tan δ	Ripple current (mA/rms85°C) (120Hz)
6.3(8)	22	5x7	0.24	45	35 (44)	4.7	5x7	0.15	30
	33	5x7	0.24	55			5x11	0.15	38
		47	5x11	0.24		70	5x11	0.15	48
	5x11		0.24	75		6.3x7	0.15	45	
	100	6.3x7	0.24	60		6.3x11	0.15	95	
		6.3x11	0.24	115		8x11	0.15	100	
	8x11	0.24	205	8x11		0.15	120		
	8x11	0.24	265	10x16		0.15	230		
	470	10x12.5	0.24	370		13x20	0.15	410	
	1000	10x20	0.24	650		330	0.15	505	
	2200	13x25	0.26	1160		470	0.15	655	
	3300	16x25	0.28	1570		1000	0.15	1140	
	4700	16x32	0.30	2020		50 (63)	1	4x7	0.15
6800	18x36	0.34	2600	5x11	0.15			18	
10(13)	10	4x7	0.20	30	2.2		4x7	0.15	20
	22	5x7	0.20	50			5x11	0.15	26
		33	5x11	0.20	65		3.3	5x7	0.15
	5x11		0.20	65	5x11			0.15	30
	47	6.3x7	0.20	55	4.7		6.3x7	0.15	30
		5x11	0.20	75			5x11	0.15	30
	6.3x7	0.20	65	10	6.3x11		0.15	45	
	100	6.3x11	0.20	125	22		8x11	0.15	80
	220	8x11	0.20	215	33		8x11	0.15	105
	330	10x16	0.20	345	47		8x15	0.15	140
	470	10x16	0.20	410	100		10x20	0.15	265
	1000	13x20	0.20	720	220	13x25	0.15	480	
	2200	16x25	0.22	1280	330	16x25	0.15	650	
3300	16x32	0.24	1690	470	16x32	0.15	840		
4700	18x36	0.26	2160	63 (79)	10	6.3x11	0.12	55	
16 (20)	4.7	4x7	0.17		20	22	8x11	0.12	90
	10	5x7	0.17		35	33	10x12.5	0.12	135
		5x11	0.17		47	47	10x16	0.12	180
	22	5x11	0.17		55	100	13x20	0.12	320
		6.3x7	0.17		47	220	16x25	0.12	575
	33	5x11	0.17		70	330	16x32	0.12	750
		6.3x7	0.17	60	470	18x36	0.12	965	
	47	6.3x7	0.17	70	80 (100)	10	8x11	0.12	65
		6.3x11	0.17	95		22	10x16	0.12	105
	100	8x11	0.17	160		33	10x16	0.12	160
	220	10x12.5	0.17	275		47	10x20	0.12	215
	330	10x16	0.17	375		100	13x25	0.12	385
	470	10x20	0.17	485		220	16x32	0.12	690
1000	13x25	0.17	855	330	18x36	0.12	860		
2200	16x32	0.19	1510	100 (125)	10	8x11	0.12	70	
3300	18x36	0.21	1980		22	10x16	0.12	135	
25 (32)	3.3	4x7	0.15		15	33	13x20	0.12	220
	4.7	5x7	0.15		20	47	13x20	0.12	240
		5x11	0.15	40	100	16x25	0.12	425	
	10	6.3x7	0.15	35	220	18x36	0.12	720	
		6.3x7	0.15	50	160 (200)	1	6.3x11	0.20	15
	22	6.3x11	0.15	65		2.2	8x11	0.20	20
		6.3x7	0.15	65		3.3	10x12.5	0.20	30
	33	6.3x11	0.15	80		4.7	10x12.5	0.20	35
		6.3x11	0.15	95		10	10x16	0.20	55
	100	8x11	0.15	160		22	13x25	0.20	105
	220	10x16	0.15	305		33	16x25	0.20	165
	330	13x20	0.15	450		47	16x26	0.20	200
	470	13x20	0.15	540		100	18x36	0.20	360
1000	16x25	0.15	950	200 (250)		1	6.3x11	0.20	15
2200	18x36	0.17	1730		2.2	8x11	0.20	20	
35 (44)	2.2	4x7	0.15		15	3.3	10x12.5	0.20	30
	3.3	5x7	0.15		20	4.7	10x16	0.20	40

Jamicon Series : NK

Teapo Series : RN

■ STANDARD RATINGS

Rated Voltage (SurageVoltage) (V)	Cap (μ F)	Case size Φ DxL(mm)	$\tan \delta$	Ripple current (mA/rms85°C) (120Hz)
200 (250)	10	13x20	0.20	70
	22	13x25	0.20	120
	33	16x25	0.20	165
	47	16x32	0.20	220
250 (300)	1	8x11	0.20	15
	2.2	10x12.5	0.20	25

Rated Voltage (SurageVoltage) (V)	Cap (μ F)	Case size Φ DxL(mm)	$\tan \delta$	Ripple current (mA/rms85°C) (120Hz)
250 (300)	3.3	10x12.5	0.20	30
	4.7	10x16	0.20	40
	10	13x20	0.20	70
	22	16x25	0.20	135
	33	16x32	0.20	180
	47	16x36	0.20	230

Jamicon Series : SN

Teapo Series : SN Non-polar Standard Series



- Endurance: 105°C 2000 hours
- Recommended Applications : Non-polar miniature type for used in reversing polarity DC voltage circuits
- Corresponding product to RoHS

■ SPECIFICATIONS

Item	Characteristics	
Category Temperature Range	-40 ~ +105°C	-25~+105°C
Rated Voltage Range	6.3 ~ 100VDC	160~250VDC
Rated Capacitance Range	1 ~ 2200 µF	1~100 µF
Capacitance Tolerance	± 20 % (120Hz , 20°C)	
Leakage Current (20°C)	I=0.03CV+ 3 µ A; L=7mm, I=0.06CV+ 10 µ A(After rated voltage applied for 2 minutes) I : Max. leakage current (µ A), C : Nominal capacitance (µ F), V : Rated voltage (V)	
Dissipation Factor(MAX) (tan δ) (120Hz ,20°C)	WV	6.3 10 16 25 35 50 63 80 100 160~250
	tan δ	0.24 0.20 0.17 0.15 0.15 0.15 0.12 0.12 0.12 0.20
When nominal capacitance is over 1000uF , tan δ shall be added 0.02 to the listed value with increase of every 1000uF;L=7mm, tan δ shall be added 0.03		
Low Temperature Stability Impedance Ratio (MAX)	WV	6.3 10 16 25 35 50 63~100 160-250
	Z(120Hz)	4 3 2 2 2 2 2 2 6
	Z-25°C / Z+20°C	10 8 6 4 3 3 3 —
Z-40°C / Z+20°C		
Endurance	After applying rated voltage with rated ripple current for2000 (L≤7mm1000) hours at 105°C , the capacitors shall meet the following requirements.	
	Capacitance change	Within ± 25% of initial value
	D.F. (tan δ)	Not more than 200% of specified value
Shelf Life	The following specifications shall be satisfied when the capacitors are restored to 20°C after exposing them for500 hours at 105°C without voltage applied. Before the measurement, the capacitor shall be preconditioned by applying voltage according to item 4.1 of JIS C 5101-4.	

■ Dimensions [mm]

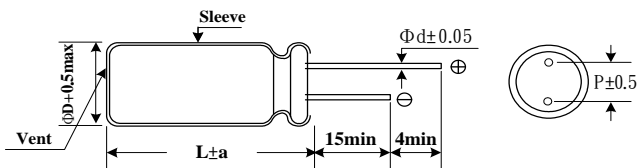

ΦD	4.0	5.0	6.3	8.0	10.0	13.0	16.0	18.0
P	1.5	2.0	2.5	3.5	5.0	5.0	7.5	7.5
Φd	0.45	0.5	0.5	0.6	0.6	0.6	0.8	0.8
a	1.0	1.5	1.5	1.5	1.5	2.0	2.0	2.0

■ Multiplier for Ripple Current

Freq. (Hz)	60	120	300	1K	10K
Factor	0.75	1.00	1.20	1.32	1.65

Jamicon Series : SN

Teapo Series : SN

■ STANDARD RATINGS

Rated Voltage (SurageVoltage) (V)	Cap (μ F)	Case size Φ DxL(mm)	$\tan \delta$	R.C (mA/rms105°C) (120Hz)	Rated Voltage (SurageVoltage) (V)	Cap (μ F)	Case size Φ DxL(mm)	$\tan \delta$	R.C (mA/rms105°C) (120Hz)
6.3(8)	33	5x11	0.24	63	50(63)	22	6.3x11	0.15	75
	47	6.3x11	0.24	84			8x11	0.15	97
	100	8x11	0.24	140			10x12.5	0.15	115
	220	10x12.5	0.24	235		33	8x11	0.15	110
	330	10x16	0.24	310			10x16	0.15	150
	470	10x20	0.24	400		47	8x11	0.15	130
	1000	13x25	0.24	690			10x20	0.15	190
2200	16x32	0.26	1250	100		13x20	0.15	310	
10(13)	22	5x11	0.20	57		220	16x25	0.15	570
	33	6.3x11	0.20	77		330	16x36	0.15	790
	47	6.3x11	0.20	93	63(79)	10	8x11	0.12	74
	100	8x11	0.20	193		22	8x11	0.12	95
	220	10x16	0.20	255			10x16	0.12	130
	330	10x20	0.20	380		33	8x11	0.12	115
	470	13x20	0.20	470			10x20	0.12	175
1000	16x25	0.20	885	47		13x20	0.12	230	
2200	16x36	0.22	1450	100		16x25	0.12	410	
16(20)	10	6.3x11	0.17	45	220	16x32	0.12	660	
	22	5x11	0.17	59	80(100)	10	10x12.5	0.12	88
		6.3x11	0.17	69		22	10x20	0.12	150
	33	8x11	0.17	98		33	13x20	0.12	205
	47	8x11	0.17	115		47	13x20	0.12	245
		8x11	0.17	140		100	16x25	0.12	435
	100	10x12.5	0.17	175	100(125)	10	8x11	0.12	80
		10x16	0.17	205		22	10x12.5	0.12	100
	220	10x20	0.17	330		33	13x20	0.12	180
	330	13x20	0.17	445		47	13x25	0.12	285
470	13x25	0.17	570	100	16x32	0.12	510		
1000	16x32	0.17	1020	160(200)	1	6.3x11	0.20	21	
25(32)	10	5x11	0.15		42	2.2	8x11	0.20	34
	22	6.3x11	0.15		50	3.3	10x12.5	0.20	49
		6.3x11	0.15		69	4.7	10x12.5	0.20	58
	33	8x11	0.15		105	10	10x17	0.20	80
	47	10x12.5	0.15		140	22	13x25	0.20	180
	100	10x20	0.15		240	33	16x26	0.20	220
	220	13x20	0.15		390	47	16x26	0.20	285
	330	16x25	0.15		580	100	18x36	0.20	510
470	16x25	0.15	690	200(250)	1	6.3x11	0.20	21	
35(44)	4.7	5x11	0.15		34	2.2	8x11	0.20	34
	10	6.3x11	0.15		54	3.3	10x12.5	0.20	49
	22	8x11	0.15		94	4.7	10x15	0.20	62
	33	10x12.5	0.15		125	10	13x20	0.20	100
	47	10x16	0.15		165	22	13x25	0.20	180
	100	13x20	0.15		285	33	16x26	0.20	220
	220	16x25	0.15	520	47	16x32	0.20	315	
330	16x25	0.15	630	250(300)	1	8x11	0.20	25	
470	16x32	0.15	820		2.2	10x12.5	0.20	38	
50(63)	2.2	5x11	0.15		25	3.3	10x12.5	0.20	49
	3.3	6.3x11	0.15		31	4.7	10x17	0.20	66
	4.7	5x11	0.15		34	10	13x20	0.20	100
		6.3x11	0.15		41	22	16x26	0.20	200
	10	6.3x11	0.15		56	33	16x32	0.20	250
		8x11	0.15	70	47	16x36	0.20	330	

Jamicon Series : LK

Teapo Series : LL

Low leakage current Series

■ Endurance : 85°C 2000 hours

■ Recommended Applications : in where low leakage current is essential as in coupling of pre-amplifiers
 Remaining of very low leakage current even after prolonged storage

■ Corresponding product to RoHS



SPECIFICATIONS

Item	Characteristics						
Category Temperature Range	-40 ~ +85°C						
Rated Voltage Range	10 ~ 63VDC						
Rated Capacitance Range	10 ~ 1000 µF						
Capacitance Tolerance	± 20 % (120Hz , 20°C)						
Leakage Current (20°C)	I ≤ 0.002CV or 1.0 µA whichever is greater. (After rated voltage applied for 2 minutes) I : Max. leakage current (µA), C : Nominal capacitance (µF), V : Rated voltage (V)						
Dissipation Factor(MAX) (tan δ) (120Hz , 20°C)	WV	10	16	25	35	50	63
	tan δ	0.24	0.20	0.16	0.14	0.12	0.10
When nominal capacitance is over 1000 µF, tan δ shall be added 0.02 to the listed value with increase of every 1000 µF.							
Low Temperature Stability Impedance Ratio (MAX)	WV	10	16	25	35	50	63
	Z(120Hz)						
	Z(-25°C) / Z(+20°C)	3	2	2	2	2	2
Z(-40°C) / Z(+20°C)	6	4	4	3	3	3	
Endurance	After applying rated voltage with rated ripple current for 2000 hours at 85°C , the capacitors shall meet the following requirements.						
	Capacitance change	Within ± 15% of initial value					
	D.F. (tan δ)	Not more than 150% of specified value					
	Leakage current	Not more than the specified value					
Shelf Life	The following specifications shall be satisfied when the capacitors are restored to 20°C after exposing them for 1,000 hours at 85°C without voltage applied. Before the measurement, the capacitor shall be preconditioned by applying voltage according to item 4.1 of JIS C 5101-4.						
	Capacitance change	Within ± 15% of initial value					
	D.F. (tan δ)	Not more than 150% of specified value					
	Leakage current	Not more than 200% of specified value					

Dimensions [mm]

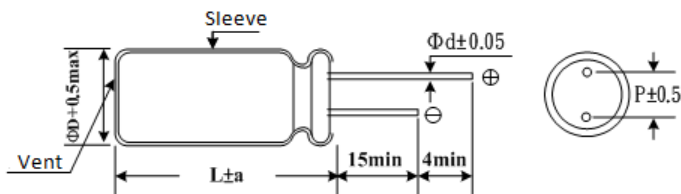

φD	5	6.3	8	10	12.5
P	2.0	2.5	3.5	5.0	5.0
φd	0.5	0.5	0.6	0.6	0.6
a	1.5	1.5	1.5	1.5	2.0

Jamicon Series : LK

Teapo Series : LL

■ STANDARD RATINGS

Rated Voltage (SurageVoltage) (V)	Cap (μ F)	Case size Φ DxL(mm)	$\tan \delta$	Ripple current (mA/rms105°C) (120Hz)	Rated Voltage (SurageVoltage) (V)	Cap (μ F)	Case size Φ DxL(mm)	$\tan \delta$	Ripple current (mA/rms105°C) (120Hz)
10V (13)	22	5x11	0.24	65	25V (32)	100	10x16	0.16	250
	33	6.3x11	0.24	90		220	12.5x20	0.16	410
	47	6.3x11	0.24	110		330	12.5x25	0.16	560
	100	8x11	0.24	180	35V (44)	10	6.3x11	0.14	65
	220	10x16	0.24	310		22	8x11	0.14	110
	330	10x20	0.24	420		33	10x12.5	0.14	140
	470	12.5x20	0.24	500		47	10x12.5	0.14	170
1000	12.5x25	0.24	810	100		10x20	0.14	300	
16V (20)	10	5x11	0.20	48	220	12.5x25	0.14	490	
	22	6.3x11	0.20	80	50V (63)	10	8x11	0.12	80
	33	6.3x11	0.20	100		22	10x12.5	0.12	130
	47	8x11	0.20	140		33	10x16	0.12	170
	100	10x12.5	0.20	210		47	10x16	0.12	210
	220	10x20	0.20	390		100	12.5x20	0.12	330
	330	12.5x20	0.20	470	63V (79)	10	8x11	0.10	80
470	12.5x20	0.20	560	22		10x16	0.10	140	
25V (32)	10	6.3x11	0.16	60		33	10x16	0.10	170
	22	8x11	0.16	100		47	10x20	0.10	230
	33	8x11	0.16	130	100	12.5x25	0.10	360	
	47	10x12.5	0.16	160					

Jamicon Series : SB

Teapo Series : SB Low leakage current Series

- Endurance : 105°C 2000 hours
- Recommended Applications :in where low leakage current is essential as in coupling of pre-amplifies
Remaining of very low leakage current even after prolonged storage
- Corresponding product to RoHS



SPECIFICATIONS

Item	Characteristics									
Category Temperature Range	-40 ~ +105°C									
Rated Voltage Range	6.3 ~ 100VDC									
Rated Capacitance Range	10 ~ 15000 μF									
Capacitance Tolerance	± 20 % (120Hz , 20°C)									
Leakage Current (20°C)	I ≤ 0.002CV or 1.0 μA whichever is greater. (After rated voltage applied for 2 minutes) I : Max. leakage current (μA), C : Nominal capacitance (μF), V : Rated voltage (V)									
Dissipation Factor(MAX) (tan δ) (120Hz ,20°C)	WV	6.3	10	16	25	35	50	63	80	100
	tan δ	0.28	0.24	0.20	0.16	0.14	0.12	0.10	0.10	0.10
When nominal capacitance is over 1000 μF,tan δ shall be added 0.02 to the listed value with increase of every 1000 μF.										
Low Temperature Stability Impedance Ratio (MAX)	WV	6.3	10	16	25	35	50	63	80	100
	Z(120Hz)									
	Z(-25°C)/Z(+20°C)	4	3	2	2	2	2	2	1.5	1.5
	Z(-40°C)/Z(+20°C)	8	6	4	4	3	3	3	2	2
Endurance	After applying rated voltage with rated ripple current for 2000hours at 105°C, the capacitors shall meet the following requirements.									
	Capacitance change	Within ± 20% of initial value								
	D.F. (tan δ)	Not more than 200% of specified value								
	Leakage current	Not more than the specified value								
Shelf Life	The following specifications shall be satisfied when the capacitors are restored to 20°C after exposing them for 500 hours at 105°C without voltage applied. Before the measurement, the capacitor shall be preconditioned by applying voltage according to item 4.1 of JIS C 5101-4.									
	Capacitance change	Within ± 20% of initial value								
	D.F. (tan δ)	Not more than 200% of specified value								
	Leakage current	Not more than 200% of specified value								

Dimensions [mm]

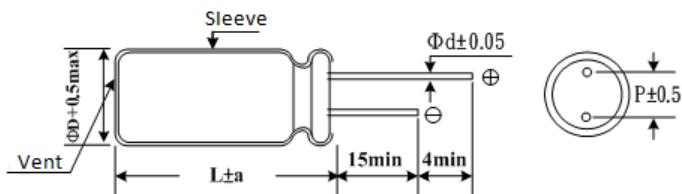

φD	5	6.3	8	10	13	16	18	22
P	2	2.5	3.5	5	5	7.5	7.5	10
φd	0.5	0.5	0.6	0.6	0.6	0.8	0.8	1.0
a	1.5	1.5	1.5	1.5	2.0	2.0	2.0	2.0

Multiplier for Ripple Current

Freq. (Hz)	50	120	300	1K	10K
6.3 ~ 25 V	0.85	1.00	1.04	1.08	1.19
35 ~ 50 V	0.80	1.00	1.30	1.40	1.43
63 ~ 100 V	0.77	1.00	1.34	1.43	1.48

Jamicon Series : SB

Teapo Series : SB

■ STANDARD RATINGS

Rated Voltage (SurageVoltage) (V)	Cap (μF)	Case size Φ D×L(mm)	tan δ	Ripple current (mA/rms105°C) (120Hz)	Rated Voltage (SurageVoltage) (V)	Cap (μF)	Case size Φ D×L(mm)	tan δ	Ripple current (mA/rms105°C) (120Hz)
6.3V (8)	33	5x11	0.28	55	25V (32)	4700	18x36	0.22	2380
	47	5x11	0.28	65		6800	18x40	0.24	2770
	100	5x11	0.28	95	35V (44)	10	5x11	0.14	45
	220	6.3x11	0.28	165		22	5x11	0.14	65
	330	6.3x11	0.28	195		33	5x11	0.14	80
	470	8x11	0.28	270		47	6.3x11	0.14	110
	1000	10x12.5	0.28	465		100	8x11	0.14	180
	2200	13x20	0.30	925		220	10x12.5	0.14	320
	3300	13x20	0.32	1100		330	10x17	0.14	450
	4700	16x26	0.34	1600		470	10x20	0.14	570
	6800	16x26	0.38	1810		1000	13x25	0.14	1060
	10000	16x32	0.46	2210		2200	16x32	0.16	1700
15000	18x36	0.56	2760	3300		18x36	0.18	2200	
10V (13)	22	5x11	0.24	50		4700	18x40	0.20	2610
	33	5x11	0.24	60	50V (63)	10	5x11	0.12	55
	47	5x11	0.24	75		22	5x11	0.12	75
	100	5x11	0.24	110		33	6.3x11	0.12	100
	220	6.3x11	0.24	180		47	6.3x11	0.12	120
	330	8x11	0.24	250		100	8x11	0.12	200
	470	8x11	0.24	300		220	10x17	0.12	400
	1000	10x17	0.24	600		330	10x20	0.12	520
	2200	13x20	0.26	1000		470	13x20	0.12	730
	3300	13x25	0.28	1300		1000	16x26	0.12	1330
	4700	16x26	0.30	1700		2200	18x36	0.14	2100
	6800	16x32	0.34	2100		63V (79)	10	5x11	0.10
10000	18x36	0.42	2630	22			6.3x11	0.10	80
16V (20)	10	5x11	0.20	40	33		6.3x11	0.10	100
	22	5x11	0.20	55	47		8x11	0.10	140
	33	5x11	0.20	70	100		10x12.5	0.10	230
	47	5x11	0.20	85	220		10x20	0.10	430
	100	6.3x11	0.20	140	330		13x20	0.10	610
	220	8x11	0.20	230	470	13x25	0.10	800	
	330	8x11	0.20	280	1000	16x32	0.10	1460	
	470	10x12.5	0.20	400	80V (100)	10	6.3x11	0.10	60
	1000	10x17	0.20	660		22	8x11	0.10	110
	2200	13x25	0.22	1210		33	8x11	0.10	130
	3300	16x26	0.24	1610		47	10x12.5	0.10	180
	4700	16x32	0.26	2020		100	10x17	0.10	310
6800	18x36	0.30	2520	220		13x20	0.10	560	
10000	18x40	0.38	2910	330		13x25	0.10	750	
25V (32)	10	5x11	0.16	40	470	16x26	0.10	1020	
	22	5x11	0.16	60	1000	18x36	0.10	1830	
	33	5x11	0.16	75	100V (125)	10	6.3x11	0.10	65
	47	5x11	0.16	90		22	8x11	0.10	115
	100	6.3x11	0.16	140		33	10x12.5	0.10	160
	220	8x11	0.16	250		47	10x17	0.10	230
	330	10x12.5	0.16	360		100	13x20	0.10	410
	470	10x17	0.16	490		220	16x26	0.10	750
	1000	13x20	0.16	880		330	16x32	0.10	920
	2200	16x26	0.18	1550	470	16x32	0.10	1200	
	3300	16x32	0.20	1860					

Jamicon Series : RV

Teapo Series : MA No Spark with DC Overvoltage Series

- Endurance: 105°C 2000 hours
- Recommended Applications : AV(TV, Video, Audio); Monitor/Computer; OA/HA/Communication; Converter/Inverter; Energy saving lamp; PFC circuit;SMPS; Ballast; Adapter
- Corresponding product to RoHS



■ SPECIFICATIONS

Item	Characteristics		
Category Temperature Range	-25~+105°C		
Rated Voltage Range	200 ~ 400VDC		
Rated Capacitance Range	2.2 ~ 220 μF		
Capacitance Tolerance	± 20 % (120Hz , 20°C)		
Leakage Current (20°C)	I=0.06CV +10 μ A (After rated voltage applied for 2 minutes) I : Max. leakage current (μ A), C : Nominal capacitance (μ F), V : Rated voltage (V)		
Dissipation Factor(MAX) (tan δ) (120Hz ,20°C)	WV	200	400
	tan δ	0.15	0.24
Low Temperature Stability Impedance Ratio (MAX)	Z (120Hz)	200	400
	Z(-25°C) / Z(20°C)	4	6
Endurance	After applying rated voltage with rated ripple current for 2000hours at 105°C , the capacitors shall meet the following requirements.		
	Capacitance change	Within ± 20% of initial value	
	D.F. (tan δ) Leakage current	Not more than 200% of specified value Not more than the specified value	
Shelf Life	The following specifications shall be satisfied when the capacitors are restored to 20°C after exposing them for 1,000 hours at 105°C without voltage applied. Before the measurement, the capacitor shall be preconditioned by applying voltage according to item 4.1 of JIS C 5101-4.		

■ Dimensions [mm]

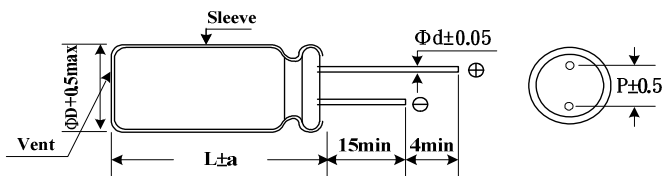

ΦD	16	18
P	7.5	7.5
Φd	0.8	0.8
a	2.0	2.0

■ Multiplier for Ripple Current

Freq. (Hz)		60	120	1K	10K	100K
W.V.	200V	0.80	1.00	1.30	1.40	1.60
	400V	0.75	1.00	1.50	1.75	1.85

Jamicon Series : RV

Teapo Series : MA

■ STANDARD RATINGS

Rated Voltage (SurageVoltage) (V)	Cap (μ F)	Case size Φ DxL(mm)	$\tan \delta$	Ripple current (mA/rms105°C) (120Hz)	Rated Voltage (SurageVoltage) (V)	Cap (μ F)	Case size Φ DxL(mm)	$\tan \delta$	Ripple current (mA/rms105°C) (120Hz)
200V (250)	100	16x25	0.15	400	400V (450)	22	16x25	0.24	170
	120	16x32	0.15	480		33	16x25	0.24	210
		18x25	0.15	470		39	16x32	0.24	260
	150	16x32	0.15	540			18x25	0.24	250
		18x25	0.15	520		47	16x32	0.24	280
	180	16x40	0.15	660		56	16x40	0.24	340
		18x32	0.15	630			18x32	0.24	330
	220	18x36	0.15	730		68	18x36	0.24	380
18x40		0.15	770	82	18x40	0.24	440		

■ DC OVERVOLTAGE TEST CONDITION

The vent will be operated and the capacity shall become an open circuit without burning the material when the following excess DC voltage is applied.

Rated Voltage	Current	Test DC Voltage
200 VDC	4A	300/375 VDC
400 VDC	2A	500/600 VDC

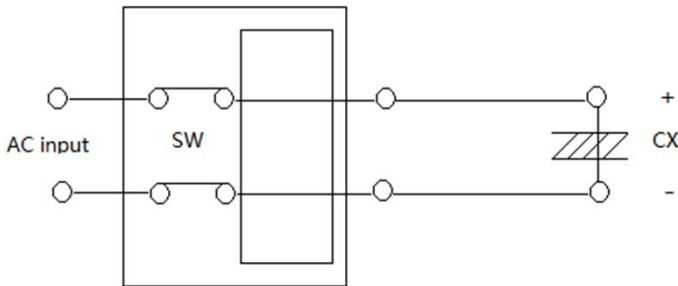

Constant DC voltage/current power supply

Jamicon Series : TP

Teapo Series : TP Low impedance · Long life Series



- Endurance: 105°C 6000~20000 hours
- Recommended Applications : Non-polar miniature type for used in reversing polarity DC voltage circuits
- Corresponding product to RoHS

■ SPECIFICATIONS

Item	Characteristics																
Category Temperature Range	-55~ +105°C																
Rated Voltage Range	10 ~35VDC																
Rated Capacitance Range	1 ~4700 µF																
Capacitance Tolerance	± 20 % (120Hz , 20°C)																
Leakage Current (20°C)	I=0.01CV +3 µ A (After rated voltage applied for 2 minutes) I : Max. leakage current (µ A), C : Nominal capacitance (µ F), V : Rated voltage (V)																
Dissipation Factor(MAX) (tan δ) (100KHz ,20°C)	<table border="1"> <tr> <td>WV</td> <td>10</td> <td>16</td> <td>25</td> <td>35</td> </tr> <tr> <td>tan δ</td> <td>0.2</td> <td>0.16</td> <td>0.14</td> <td>0.12</td> </tr> </table> <p>When nominal capacitance is over 1000uF , tan δ shall be added 0.02 to the listed value with increase of every 1000uF;L=7mm, tan δ shall be added 0.03</p>	WV	10	16	25	35	tan δ	0.2	0.16	0.14	0.12						
WV	10	16	25	35													
tan δ	0.2	0.16	0.14	0.12													
Low Temperature Stability Impedance Ratio (MAX)	<table border="1"> <tr> <td rowspan="3">Z(120Hz)</td> <td>WV</td> <td>10</td> <td>16</td> <td>25</td> <td>35</td> </tr> <tr> <td>Z-25°C / Z+20°C</td> <td>3</td> <td>2</td> <td>2</td> <td>2</td> </tr> <tr> <td>Z-55°C / Z+20°C</td> <td>4</td> <td>4</td> <td>4</td> <td>4</td> </tr> </table>	Z(120Hz)	WV	10	16	25	35	Z-25°C / Z+20°C	3	2	2	2	Z-55°C / Z+20°C	4	4	4	4
Z(120Hz)	WV		10	16	25	35											
	Z-25°C / Z+20°C		3	2	2	2											
	Z-55°C / Z+20°C	4	4	4	4												
Endurance	<p>After applying rated voltage for 6000 hours (≥12.5 φ 10000 , ≥16 φ 20000) hours at 105°C the capacitors shall meet the following requirements.</p> <table border="1"> <tr> <td>Capacitance change</td> <td>Within ± 30% of initial value</td> </tr> <tr> <td>D.F. (tan δ)</td> <td>Not more than 300% of specified value</td> </tr> <tr> <td>Leakage current</td> <td>Not more than the specified value</td> </tr> </table>	Capacitance change	Within ± 30% of initial value	D.F. (tan δ)	Not more than 300% of specified value	Leakage current	Not more than the specified value										
Capacitance change	Within ± 30% of initial value																
D.F. (tan δ)	Not more than 300% of specified value																
Leakage current	Not more than the specified value																
Shelf Life	The following specifications shall be satisfied when the capacitors are restored to 20°C after exposing them for 1,000 hours at 105°C without voltage applied. Before the measurement, the capacitor shall be preconditioned by applying voltage according to item 4.1 of JIS C 5101-4.																

■ Dimensions [mm]

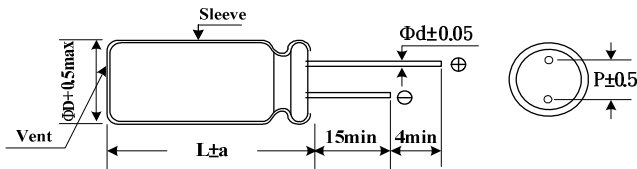

ΦD	10	13	16	18
P	5.0	5.0	7.5	7.5
Φd	0.6	0.6	0.8	0.8
a	1.5	2.0	2.0	2.0

■ Multiplier for Ripple Current

Freq. (Hz)	120	1k	10k	100k
Factor	0.75	0.80	0.90	1.00

Jamicon Series : TP

Teapo Series : TP

■ STANDARD RATINGS

Rated Voltage (SurageVoltage) (V)	Cap (μ F)	Case size Φ D \times L(mm)	tan δ	R.C (mA/rms105°C) (100KHz)	Rated Voltage (SurageVoltage) (V)	Cap (μ F)	Case size Φ D \times L(mm)	tan δ	R.C (mA/rms105°C) (100KHz)
10V (13)	330	10x16	0.20	510	25V (33)	470	16x25	0.14	1500
	470	10x20	0.20	680		1000	16x32	0.14	1640
	1000	12.5x25	0.20	1050	35V (44)	1	10x12.5	0.12	60
	2200	16x32	0.22	1740		2.2	10x12.5	0.12	90
	3300	18x36	0.24	2050		3.3	10x12.5	0.12	110
	4700	18x40	0.26	2290		4.7	10x12.5	0.12	140
16V (20)	220	10x16	0.16	520		10	10x12.5	0.12	300
	330	10x20	0.16	680		22	10x12.5	0.12	350
	470	12.5x20	0.16	1000		33	10x12.5	0.12	380
	1000	16x25	0.16	1410		47	10x12.5	0.12	420
	2200	18x36	0.18	2120		100	10x20	0.12	670
3300	18x40	0.20	2160	220		12.5x25	0.12	1080	
25V (33)	100	10x12.5	0.14	420	330	16x25	0.12	1330	
	220	12.5x20	0.14	860	470	16x32	0.12	1690	
	330	12.5x25	0.14	1170	1000	18x40	0.12	2170	

Jamicon Series : TW

Teapo Series : TE

LED Lighting · Ultra Long Life Series

- Endurance : 105°C 12000~20000hrs
- Recommended Applications : For LED Lighting
- Corresponding product to RoHS



SPECIFICATIONS

Item	Characteristics			
Category Temperature Range	-40 ~ +105°C			
Rated Voltage Range	160~400VDC			
Rated Capacitance Range	1.0 ~ 33 μF			
Capacitance Tolerance	± 20 % (120Hz , 20°C)			
Leakage Current (20°C)	CV ≤ 1000	CV > 1000		I : Max. leakage current (μ A) C : Nominal capacitance (μ F) V : Rated voltage (V)
	I=0.1CV +40 μ A (1 minute)	I=0.04CV +100 μ A (1minute)		
	I=0.03CV +15 μ A (5 minute)	I=0.02CV +25 μ A (5minute)		
Dissipation Factor(MAX) (tan δ) (120Hz , 20°C)	WV	160	200	400
	tan δ	0.24	0.24	0.24
Low Temperature Stability Impedance Ratio (MAX)	WV	160	200	400
	Z((120HZ) Z-25°C / Z+20°C	3	3	6
	Z-40°C / Z+20°C	8	8	10
Endurance	After applying rated voltage with rated ripple current for 12000~20000hours at 105°C , the capacitors shall meet the following requirements.			
	Capacitance change	Within ± 30% of initial value		Φ D×L
	D.F. (tan δ)	Not more than 300% of specified value		Life time (hours)
	Leakage current	initial specified value or less		
				6.3x11,8x9,10x9
				8x11,10x12.5
				10x16
Shelf Life	The following specifications shall be satisfied when the capacitors are restored to 20°C after exposing them for 1,000 hours at 105°C without voltage applied. Before the measurement, the capacitor shall be preconditioned by applying voltage according to item 4.1 of JIS C 5101-4.			

Dimensions [mm]

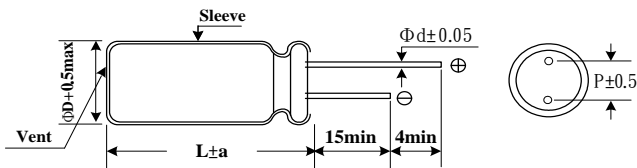

ΦD	6.3	8.0	10.0
P	2.5	3.5	5.0
Φd	0.5	0.6	0.6
a	2.0	2.0	2.0

Multiplier for Ripple Current

	Freq. (Hz)	120	1K	10K	100K
coefficient	1~5.6 μF	1.0	1.6	1.8	2.0
	6.8~18 μF	1.0	1.5	1.7	1.9
	22~33 μF	1.0	1.4	1.6	1.8

Jamicon Series : TW

Teapo Series : TE

■ STANDARD RATINGS

Rated Voltage (SurageVoltage) (V)	Cap (μ F)	Case size Φ D \times L(mm)	tan δ	Ripple current (mA/rms105°C) (120Hz)	Rated Voltage (SurageVoltage) (V)	Cap (μ F)	Case size Φ D \times L(mm)	tan δ	Ripple current (mA/rms105°C) (120Hz)	
160	5.6	6.3x11	0.24	52	200	18	10x12.5	0.24	113	
	10	8x9	0.24	70		27	10x16	0.24	149	
	15	8x11	8x11	0.24	92	400	1.0	6.3x11	0.24	24
			10x9	0.24	95		1.2	8x9	0.24	28
		22	10x12.5	0.24	121		1.5	8x9	0.24	30
33	10x16	0.24	158	1.8	8x9		0.24	33		
200	2.2	6.3x11	0.24	36	2.2		8x9	0.24	36	
	3.3	6.3x11	0.24	42	2.7		8x11	0.24	40	
	4.7	6.3x11	0.24	49			8x11	0.24	43	
	5.6	8x9	0.24	56	3.3		8x11	0.24	47	
	6.8	8x9	0.24	62			10x9	0.24	48	
	8.2	8x9	0.24	66	3.9		10x12.5	0.24	57	
	10	8x11	0.24	80	4.7	10x12.5	0.24	61		
	12	10x9	0.24	88	6.8	10x16	0.24	85		

Jamicon Series : LS

Teapo Series : LH Standard Series

- Endurance: 85°C 2000hours
- Recommended Applications : Applying to switching power supply and other industry/ commercial field
- Corresponding product to RoHS

550V LINEUP



■ SPECIFICATIONS

Item	Characteristics																			
Category Temperature Range	-40~+85°C						-40~+85°C						-25~+85°C							
Rated Voltage Range	6.3 ~ 100VDC						160 ~ 500VDC						DC > 500V							
Rated Capacitance Range	820 ~ 120000 µF						47 ~ 2700 µF						100~330 µF							
Capacitance Tolerance	± 20 % (120Hz , 20°C)																			
Leakage Current (20°C)	DC≤500V I = 3 \sqrt{CV} DC> 500V I=0.02CV . (After rated voltage applied for 5minutes) I : Max. leakage current (µA), C : Nominal capacitance (µF), V : Rated voltage (V)																			
Dissipation Factor(MAX) (tan δ) (120Hz ,20°C)	WV	6.3	10	16	25	35	50	63	80	100	160~400	420~450	500~550							
	Cap.	-	-	≤47000	≥56000	≤39000	≥47000	≤27000	≥33000	≤6800	≥8200	≤6800	≥8200	≤2200	≥2700	≤3300	≥3900	-	-	-
	tan δ	0.60	0.55	0.5	0.6	0.4	0.5	0.35	0.4	0.3	0.35	0.25	0.35	0.20	0.25	0.20	0.25	0.15	0.20	0.25
Low Temperature Stability Impedance Ratio (MAX)	Measurement frequency : 120Hz																			
	WV	6.3~16			25	35	50~63		80~100	160~400		420~450	500~550							
	Z-25°C / Z+20°C	3			3	3	2		2	4		8	8							
Z-40°C / Z+20°C	12			10	8	6		5	—		—	—								
Endurance	After applying rated voltage with rated Ripple current for 2000hrs at 85°C,when the capacitors are restored to 20°C, the capacitor shall meet the following requirements.																			
	Capacitance change	Within ± 20% of initial value																		
	D.F. (tan δ)	Not more than 200% of specified value																		
Shelf Life	The following specifications shall be satisfied when the capacitors are restored to 20°C after exposing them for 1,000 hours at 85°C without voltage applied. Before the measurement, the capacitor shall be preconditioned by applying voltage according to item 4.1 of JIS C 5101-4.																			

■ Dimensions [mm]

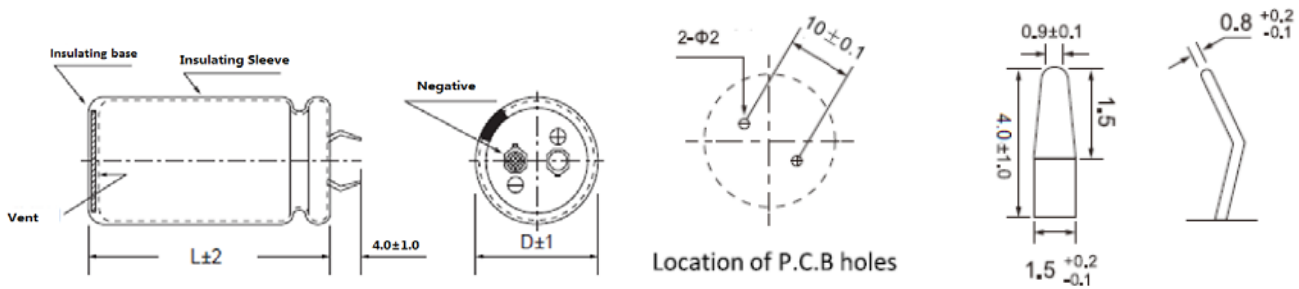

※When the code 11~13 of part number is S1G, the terminal length of standard capacitor is 4.0±1.0mm, and when it is S1A, the terminal length of standard capacitor is 5.8±1.0mm.

■ Multiplier for Ripple Current

频率 (Hz)	50	60	120	1K	10K~100K
6.3~100V	0.88	0.90	1.00	1.20	1.20
160~250V	0.75	0.78	1.00	1.30	1.50
350~450V	0.74	0.76	1.00	1.35	1.45
500~550V	0.72	0.74	1.00	1.30	1.40

Jamicon Series : LS

Teapo Series : LH

■ STANDARD RATINGS

Rated Voltage (SurageVoltage) (V)	Cap (μ F)	Case size Φ DxL(mm)	$\tan \delta$	Ripple current (A/rms85°C) (120Hz)	Rated Voltage (SurageVoltage) (V)	Cap (μ F)	Case size Φ DxL(mm)	$\tan \delta$	Ripple current (A/rms85°C) (120Hz)
6.3 (8)	15000	22x25	0.60	2.44	16 (20)	18000	22x40	0.50	3.70
	18000	22x30	0.60	2.60			25x35	0.50	3.75
		25x25	0.60	2.62			30x30	0.50	3.80
	22000	22x30	0.60	3.06			22x50	0.50	4.35
		25x25	0.60	3.07		25x40	0.50	4.30	
	27000	22x35	0.60	3.49		30x30	0.50	4.25	
		25x30	0.60	3.52		35x25	0.50	4.20	
			30x25	0.60		3.57	25x45	0.50	4.70
	33000	22x40	0.60	3.97		30x35	0.50	4.65	
		25x35	0.60	4.02		35x30	0.50	4.65	
		30x30	0.60	4.05		30x40	0.50	5.35	
	39000	35x25	0.60	4.10		35x30	0.50	5.40	
		22x50	0.60	4.56		30x45	0.50	6.00	
		25x40	0.60	4.50		35x35	0.50	5.95	
	47000	30x30	0.60	4.46		47000	30x50	0.50	6.80
		35x25	0.60	4.51		35x40	0.50	6.75	
		25x45	0.60	5.09		56000	35x45	0.60	7.60
	56000	30x35	0.60	5.06		68000	35x50	0.60	8.00
		35x30	0.60	5.03		82000	35x60	0.60	8.50
		25x50	0.60	5.71		5600	22x25	0.40	2.20
68000	30x40	0.60	5.70	6800	22x30	0.40	2.69		
	35x30	0.60	5.75	8200	25x25	0.40	2.56		
	30x45	0.60	6.48	8200	22x35	0.40	2.70		
82000	35x35	0.60	6.42	10000	25x25	0.40	2.75		
	30x50	0.60	7.32	10000	22x40	0.40	3.10		
	35x40	0.60	7.29	10000	25x30	0.40	3.15		
100000	35x45	0.60	8.31	10000	30x25	0.40	3.20		
120000	35x50	0.60	8.60	12000	22x45	0.40	3.50		
10 (13)	12000	22x25	0.55	2.40	25 (32)	12000	25x35	0.40	3.45
	15000	22x30	0.55	2.75			30x30	0.40	3.50
		25x25	0.55	2.75			35x25	0.40	3.55
	18000	22x35	0.55	3.15			22x50	0.40	4.00
		25x25	0.55	3.05		25x40	0.40	3.95	
	22000	22x40	0.55	3.55		30x35	0.40	4.00	
		25x30	0.55	3.50		35x30	0.40	4.05	
		30x25	0.55	3.55		25x45	0.40	4.45	
	27000	22x45	0.55	4.05		30x35	0.40	4.45	
		25x35	0.55	4.00		35x30	0.40	4.60	
		30x30	0.55	4.05		30x40	0.40	5.20	
	33000	22x50	0.55	4.60		22000	35x35	0.40	5.15
		25x40	0.55	4.55		30x45	0.40	5.95	
		30x30	0.55	4.50		35x40	0.40	5.90	
	39000	35x25	0.55	4.50		27000	30x50	0.40	6.70
		25x45	0.55	5.10		35x45	0.40	6.75	
		30x35	0.55	5.05		33000	35x50	0.40	7.55
	47000	35x30	0.55	5.05		39000	35x45	0.40	7.56
		25x50	0.55	5.75		47000	35x50	0.50	8.30
		30x40	0.55	5.70		3900	22x25	0.35	2.20
56000	30x45	0.55	6.45	4700	22x30	0.35	2.41		
	35x35	0.55	6.40	5600	25x25	0.35	2.40		
	30x50	0.55	7.05	5600	22x35	0.35	2.75		
68000	35x40	0.55	7.10	5600	25x25	0.35	2.75		
	35x50	0.55	7.50	6800	22x40	0.35	2.85		
	82000	35x50	0.55	7.50	6800	25x30	0.35	2.85	
16 (20)	8200	22x25	0.50	2.60	35 (44)	8200	30x25	0.35	2.90
	10000	22x30	0.50	2.81			22x45	0.35	3.15
		25x25	0.50	2.75		25x35	0.35	3.10	
	12000	22x30	0.50	2.90		30x30	0.35	3.15	
		25x25	0.50	2.95		10000	22x50	0.35	3.55
	15000	22x35	0.50	3.30		10000	25x40	0.35	3.50
		25x30	0.50	3.45		10000	30x30	0.35	3.45
	30x25	0.50	3.50	10000		35x25	0.35	3.40	

Jamicon Series : LS

Teapo Series : LH

■ STANDARD RATINGS

Rated Voltage (SurageVoltage) (V)	Cap (μ F)	Case size Φ DxL(mm)	$\tan \delta$	Ripple current (A/rms85°C) (120Hz)	Rated Voltage (SurageVoltage) (V)	Cap (μ F)	Case size Φ DxL(mm)	$\tan \delta$	Ripple current (A/rms85°C) (120Hz)	
35(44)	12000	25x45	0.35	3.95	63(79)	8200	35x35	0.35	4.80	
		30x35	0.35	4.00		10000	30x50	0.35	5.50	
		35x30	0.35	4.05		35x40	0.35	5.45		
	15000	25x50	0.35	4.95		12000	35x45	0.35	6.20	
		30x40	0.35	4.95		80 (100)	1200	22x25	0.20	1.65
		35x35	0.35	5.00			1500	22x30	0.20	1.90
	18000	30x45	0.35	5.50			25x25	0.20	1.90	
		35x40	0.35	5.55			1800	22x35	0.20	2.20
	22000	30x50	0.35	6.00				25x30	0.20	2.20
		35x45	0.35	6.05				30x25	0.20	2.20
27000	35x50	0.35	6.90	22x40	0.20		2.45			
	50 (63)	2200	22x25	0.30	1.93		2200	25x30	0.20	2.45
2700		22x30	0.30	2.10	30x25		0.20	2.50		
		25x25	0.30	2.20	2700		22x45	0.25	2.80	
3300		22x30	0.30	2.35		25x35	0.25	2.80		
		25x25	0.30	2.35		30x30	0.25	2.85		
3900		22x35	0.30	2.65	35x25	0.25	2.85			
		25x30	0.30	2.65	22x50	0.25	3.15			
		30x25	0.30	2.65	25x40	0.25	3.20			
4700		22x40	0.30	3.00	3300	30x30	0.25	3.20		
		25x35	0.30	3.00		35x25	0.25	3.20		
	30x25	0.30	2.95	3900		25x45	0.25	3.60		
	22x45	0.30	3.35		30x35	0.25	3.60			
25x40	0.30	3.35	35x30		0.25	3.60				
5600	30x30	0.30	3.35	4700	25x50	0.25	4.05			
	35x25	0.30	3.40		30x40	0.25	4.05			
	22x50	0.30	3.80		35x35	0.25	4.10			
	6800	25x40	0.30	3.80	5600	30x45	0.25	4.55		
30x30		0.30	3.80	35x35		0.25	4.50			
30x35		0.30	3.85	6800		30x50	0.25	5.15		
35x30		0.30	3.85		35x40	0.25	5.15			
8200	25x50	0.35	4.35	8200	35x45	0.25	5.85			
	30x40	0.35	4.35		10000	35x50	0.25	6.60		
	35x30	0.35	4.40	100 (125)	820	22x25	0.20	1.85		
	10000	30x45	0.35		5.00	1000	22x30	0.20	2.10	
35x35		0.35	4.95		25x25	0.20	2.10			
12000	30x50	0.35	5.60		1200	22x35	0.20	2.40		
	35x40	0.35	5.55			25x30	0.20	2.45		
15000	35x45	0.35	6.45		1500	22x40	0.20	2.70		
18000	35x50	0.35	6.70			25x30	0.20	2.75		
	30x25	0.20	2.75			1800	30x25	0.20	2.75	
1800	22x25	0.25	1.85		22x45		0.20	3.10		
	2200	22x30	0.25		2.30		25x35	0.20	3.15	
25x25		0.25	2.30	30x30	0.20		3.15			
2700	22x35	0.25	2.45	35x25	0.20	3.15				
	25x30	0.25	2.45	2200	22x50	0.20	3.50			
	30x25	0.25	2.50		25x40	0.20	3.55			
3300	22x40	0.25	2.60		30x30	0.20	3.55			
	25x30	0.25	2.65	35x25	0.20	3.60				
	30x25	0.25	2.70	2700	25x45	0.20	4.10			
3900	22x45	0.25	2.95		30x35	0.20	4.05			
	25x35	0.25	2.95		35x30	0.20	4.05			
	30x30	0.25	3.00	3300	25x50	0.20	4.50			
4700	22x50	0.25	3.40		30x40	0.20	4.55			
	25x40	0.25	3.35		35x30	0.20	4.50			
	30x30	0.25	3.35		3900	30x45	0.25	5.15		
	35x25	0.25	3.40	35x35		0.25	5.10			
5600	25x45	0.25	3.70	4700	35x40	0.25	5.75			
	30x35	0.25	3.75		5600	35x50	0.25	6.20		
	35x30	0.25	3.75	160 (200)	270	22x25	0.15	1.15		
6800	30x40	0.25	4.25		330	22x25	0.15	1.40		
	35x30	0.25	4.20			25x20	0.15	1.35		
8200	30x45	0.35	4.80							

Jamicon Series : LS

Teapo Series : LH

■ STANDARD RATINGS

Rated Voltage (SurageVoltage) (V)	Cap (μ F)	Case size Φ DxL(mm)	$\tan \delta$	Ripple current (A/rms85°C) (120Hz)	Rated Voltage (SurageVoltage) (V)	Cap (μ F)	Case size Φ DxL(mm)	$\tan \delta$	Ripple current (A/rms85°C) (120Hz)
160(200)	390	22x30	0.15	1.55	180 (225)	1500	30x45	0.15	4.15
		25x25	0.15	1.55			35x35	0.15	4.09
		30x25	0.15	1.65			35x40	0.15	3.80
	470	22x30	0.15	1.75		1800	35x40	0.15	4.73
		25x25	0.15	1.75			35x45	0.15	4.30
		30x25	0.15	1.85			35x45	0.15	4.90
	560	22x30	0.15	1.95		2200	35x50	0.15	4.90
		25x30	0.15	2.10			180	22x25	0.15
		30x25	0.15	2.10		220	22x25	0.15	1.43
	680	22x40	0.15	2.32	270	22x25	0.15	1.67	
		25x30	0.15	2.21		22x30	0.15	1.75	
		30x25	0.15	2.29		25x25	0.15	1.75	
	820	22x45	0.15	2.68	330	22x25	0.15	1.60	
		25x35	0.15	2.58		22x30	0.15	1.66	
		30x30	0.15	2.70		25x25	0.15	1.66	
	1000	35x25	0.15	2.50	390	22x30	0.15	1.80	
		22x50	0.15	3.11		25x25	0.15	1.80	
		25x40	0.15	3.00		22x35	0.15	2.11	
	1200	30x35	0.15	2.80	470	25x30	0.15	2.13	
		35x25	0.15	3.02		30x25	0.15	2.21	
25x45		0.15	3.49	22x40		0.15	2.44		
1500	30x35	0.15	3.48	560	25x35	0.15	2.48		
	35x30	0.15	3.59		30x25	0.15	2.41		
	30x45	0.15	3.75		22x45	0.15	2.83		
1800	35x35	0.15	4.26	680	25x35	0.15	2.73		
	30x50	0.15	4.20		30x30	0.15	2.85		
	35x40	0.15	4.20		35x25	0.15	2.92		
2200	35x40	0.15	4.60	820	25x40	0.15	3.17		
	35x45	0.15	4.80		25x45	0.15	3.25		
	35x50	0.15	5.45		30x30	0.15	3.13		
180 (225)	180	22x20	0.15	1.00	30x35	0.15	3.22		
		22x25	0.15	1.10	35x30	0.15	3.40		
	270	22x25	0.15	1.25	25x45	0.15	3.55		
		25x20	0.15	1.25	25x50	0.15	3.87		
	330	22x25	0.15	1.40	30x35	0.15	3.68		
		22x30	0.15	1.40	30x40	0.15	3.82		
		25x25	0.15	1.40	35x30	0.15	3.80		
	390	22x30	0.15	1.60	1200	25x50	0.15	4.05	
		25x25	0.15	1.60		30x40	0.15	4.26	
		22x35	0.15	1.80		30x45	0.15	4.46	
	470	25x30	0.15	1.80	1500	35x30	0.15	4.17	
		30x25	0.15	1.80		35x35	0.15	4.42	
		22x35	0.15	2.00		30x45	0.15	4.50	
	560	22x40	0.15	2.00	1800	30x50	0.15	4.55	
		25x30	0.15	1.99		35x35	0.15	4.52	
		30x25	0.15	2.06		35x40	0.15	5.02	
	680	22x45	0.15	2.25	2200	35x40	0.15	5.30	
		25x35	0.15	2.34		35x45	0.15	5.45	
		30x30	0.15	2.20		35x45	0.15	5.60	
	820	35x25	0.15	2.20	35x50	0.15	5.65		
22x50		0.15	2.55	250 (300)	120	22x20	0.15	1.00	
25x40		0.15	2.72		150	22x25	0.15	1.03	
30x30	0.15	2.68	180		22x25	0.15	1.13		
30x35	0.15	2.60			25x20	0.15	1.10		
1000	35x25	0.15	2.75		220	22x25	0.15	1.31	
	25x45	0.15	3.16			22x35	0.15	1.45	
	30x35	0.15	3.15		25x25	0.15	1.45		
1200	35x30	0.15	2.90		270	22x30	0.15	1.57	
	30x40	0.15	3.65			25x25	0.15	1.57	
	35x30	0.15	3.56	330		22x30	0.15	1.65	
35x35	0.15	3.30	25x25		0.15	1.80			
					30x25	0.15	1.86		

Jamicon Series : LS

Teapo Series : LH

■ STANDARD RATINGS

Rated Voltage (Surge Voltage) (V)	Cap (μF)	Case size Φ DxL(mm)	tan δ	Ripple current (A/rms85°C) (120Hz)	Rated Voltage (Surge Voltage) (V)	Cap (μF)	Case size Φ DxL(mm)	tan δ	Ripple current (A/rms85°C) (120Hz)
250 (300)	390	22x35	0.15	2.01	400 (450)	150	30x25	0.15	1.25
		25x30	0.15	2.03		180	22x40	0.15	1.38
		30x25	0.15	2.10			22x45	0.15	1.43
	470	22x40	0.15	2.34			25x35	0.15	1.40
		25x35	0.15	2.38		30x30	0.15	1.42	
		30x25	0.15	2.31		22x50	0.15	1.69	
	560	35x25	0.15	2.54		220	25x40	0.15	1.64
		22x45	0.15	2.56			30x30	0.15	1.62
		25x40	0.15	2.74			35x25	0.15	1.66
	680	30x30	0.15	2.71		270	22x50	0.15	1.78
		35x25	0.15	2.78			25x40	0.15	1.73
		25x45	0.15	3.19			30x35	0.15	1.91
	820	30x35	0.15	3.18		330	35x30	0.15	1.97
		35x25	0.15	2.95			25x45	0.15	2.10
		30x40	0.15	3.69			25x50	0.15	2.22
1000	35x30	0.15	3.60	390	30x40	0.15	2.23		
	30x45	0.15	4.28		35x30	0.15	2.18		
	35x35	0.15	4.22		30x40	0.15	2.50		
1200	35x40	0.15	4.88	470	30x45	0.15	2.55		
	1500	35x45	0.15		5.20	35x35	0.15	2.52	
		30x45	0.15		2.80	30x45	0.15	2.80	
68		22x20	0.15	0.55	560	30x50	0.15	2.90	
	22x25	0.15	0.65	35x40		0.15	2.92		
82	25x20	0.15	0.65	680	30x50	0.15	3.30		
	22x30	0.15	0.90		35x45	0.15	3.34		
100	25x20	0.15	0.90	420 (470)	120	22x30	0.20	0.95	
	22x30	0.15	1.00		150	22x35	0.20	1.05	
120	25x25	0.15	1.00	25x30		0.20	1.05		
	22x35	0.15	1.15	30x25		0.20	1.05		
150	25x30	0.15	1.15	180	22x40	0.20	1.35		
	30x25	0.15	1.15		220	22x45	0.20	1.40	
180	22x40	0.15	1.30	22x50		0.20	1.55		
	25x30	0.15	1.25	25x40		0.20	1.50		
220	30x25	0.15	1.25	25x45	0.20	1.60			
	22x45	0.15	1.45	270	25x40	0.20	1.50		
	25x35	0.15	1.45		30x40	0.20	1.60		
270	30x30	0.15	1.45	330	25x45	0.20	1.75		
	35x25	0.15	1.45		25x50	0.20	1.85		
	25x40	0.15	1.65		30x40	0.20	1.75		
330	30x35	0.15	1.65	390	30x45	0.20	1.90		
	35x25	0.15	1.65		30x45	0.20	1.90		
	25x45	0.15	1.82	470	30x45	0.20	2.10		
30x35	0.15	1.82	30x50		0.20	2.20			
390	35x30	0.15	1.88	560	30x50	0.20	2.30		
	30x40	0.15	2.10		35x45	0.20	2.30		
	35x30	0.15	2.04	450 (500)	47	22x25	0.20	0.50	
470	30x40	0.15	2.30		56	22x25	0.20	0.65	
	35x35	0.15	2.38	68	22x25	0.20	0.67		
560	35x40	0.15	2.75		22x30	0.20	0.70		
680	35x45	0.15	3.18		25x25	0.20	0.70		
	56	22x20	0.15	0.55	82	22x30	0.20	0.83	
22x25		0.15	0.60	25x25		0.20	0.83		
68		25x20	0.15	0.60	100	22x30	0.20	0.93	
	22x25	0.15	0.80	22x35		0.20	0.97		
82	25x20	0.15	0.80	25x30		0.20	0.98		
	22x25	0.15	0.85	120	30x25	0.20	1.02		
100	22x30	0.15	0.90		22x30	0.20	0.98		
	25x25	0.15	0.91		22x40	0.20	1.13		
120	22x30	0.15	1.00	150	25x30	0.20	1.08		
	22x35	0.15	1.05		30x25	0.20	1.12		
150	25x25	0.15	1.05	22x35	0.20	1.13			
	22x35	0.15	1.19						
400 (450)	25x30	25x30	0.15	1.20					

Jamicon Series : LS

Teapo Series : LH

■ STANDARD RATINGS

Rated Voltage (SurageVoltage) (V)	Cap (μ F)	Case size Φ DxL(mm)	$\tan \delta$	Ripple current (A/rms85°C) (120Hz)	Rated Voltage (SurageVoltage) (V)	Cap (μ F)	Case size Φ DxL(mm)	$\tan \delta$	Ripple current (A/rms85°C) (120Hz)	
450 (500)	150	22x45	0.20	1.33	500(550)	120	30x30	0.20	1.00	
		25x35	0.20	1.28			35x25	0.20	1.00	
		30x30	0.20	1.34		150	22x50	0.20	1.40	
	180	25x40	0.20	1.49			30x35	0.20	1.20	
		30x30	0.20	1.47		180	30x40	0.20	1.40	
		35x25	0.20	1.50			35x30	0.20	1.33	
	220	220	22x45	0.20		1.58	220	30x45	0.20	1.60
			25x45	0.20		1.73		35x35	0.20	1.57
			30x35	0.20		1.72	270	30x50	0.20	1.84
		35x30	0.20	1.78		35x40		0.20	1.75	
	270	270	25x50	0.20		2.05	330	35x45	0.20	2.13
			30x40	0.20		2.02		390	35x50	0.20
			35x35	0.20		2.10	550(600)	100	22x45	0.25
		30x40	0.20	2.12		30x30			0.25	1.05
		330	30x45	0.20		2.35		120	30x35	0.25
	35x35		0.20	2.32		35x30			0.25	1.25
	390		30x45	0.20		2.45		150	30x40	0.25
		35x40	0.20	2.66		35x30			0.25	1.45
470	470	30x45	0.20	3.07	180	30x45		0.25	1.65	
		35x50	0.20	3.20		35x35		0.25	1.65	
	560	35x50	0.20	3.36	220	30x50	0.25	1.90		
680	35x60	0.20	3.45	35x40		0.25	1.90			
500(550)	100	22x40	0.20	1.00	270	35x45	0.25	2.25		
		30x25	0.20	0.90	330	35x50	0.25	2.60		

Jamicon Series : HS

Teapo Series : LG Standard Series

- Endurance: 105°C 2000 hours
- Recommended Applications : Applying to switching power supply and other industr High temperature
- Corresponding product to RoHS



SPECIFICATIONS

Item	Characteristics																			
Category Temperature Range	-40 ~ +105°C						-40~ +105°C						-25~ +105°C							
Rated Voltage Range	6.3 ~ 100VDC						160 ~ 500VDC						DC > 500V							
Rated Capacitance Range	560 ~ 82000 µF						47 ~ 2200 µF						47 ~ 390 µF							
Capacitance Tolerance	± 20 % (120Hz ,																			
Leakage Current (20°C)	DC ≤ 500V $I = \sqrt[3]{CV}$ DC > 500V $I = 0.02CV$ or 3mA whichever is greater (After rated voltage applied for 5minutes) I : Max. leakage current (µA), C : Nominal capacitance (µF), V : Rated voltage (V)																			
Dissipation Factor(MAX) (tan δ) (120Hz, 20°C)	WV	6.3	10	16	25	35	50	63	80	100	160~400	420~450	500~550							
	capacitance	-	-	≤33000	≥39000	≤33000	≥47000	≤22000	≥27000	≤6800	≥8200	≤6800	≥8200	≤3300	≥4700	≤3300	≥3900	-	-	-
	tan δ	0.60	0.55	0.5	0.6	0.4	0.5	0.35	0.4	0.3	0.35	0.25	0.35	0.20	0.25	0.20	0.25	0.15	0.20	0.25
Low Temperature Stability Impedance Ratio (MAX)	Measurement frequency : 120Hz																			
	Rated voltage(V)	6.3~16			25	35	50~63		80~100		160~400		420~450		500~550					
	Z-25°C / Z+20°C	4			3	3	2		2		4		8		8					
Z-40°C / Z+20°C	15			10	8	6		5		-		-		-						
Endurance	After applying rated voltage with rated Ripple current for 2000hrs at 105°C, when the capacitors are restored to 20°C, the capacitor shall meet the following requirements.																			
	Capacitance change	Within ± 20% of initial value																		
	D.F. (tan δ)	Not more than 200% of specified value																		
Shelf Life	The following specifications shall be satisfied when the capacitors are restored to 20°C after exposing them for 1,000 hours at 105°C without voltage applied. Before the measurement, the capacitor shall be preconditioned by applying voltage according to item 4.1 of JIS C 5101-4.																			

Dimensions [mm]

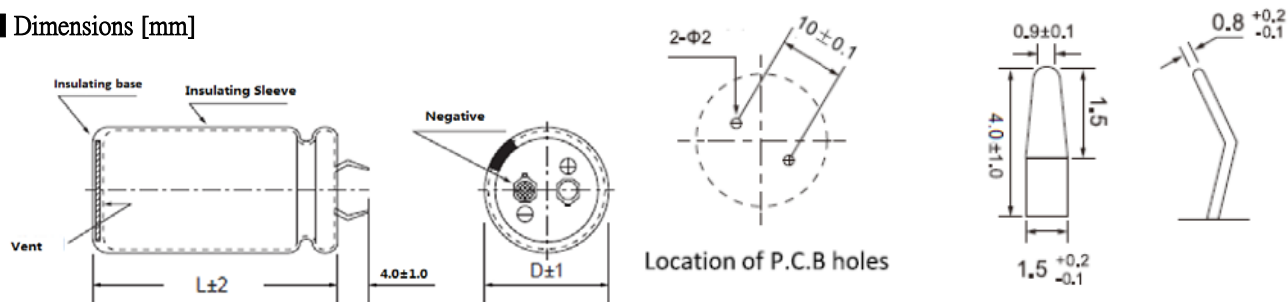

※When the code 11~13 of part number is S1G, the terminal length of standard capacitor is 4.0±1.0mm, and when it is S1A, the terminal length of standard capacitor is 5.8±1.0mm.

Multiplier for Ripple Current

Freq. (Hz)	50	60	120	1K	10K~100K
6.3~100V	0.88	0.90	1.00	1.20	1.30
160~250V	0.85	0.88	1.00	1.30	1.50
315~450V	0.88	0.90	1.00	1.35	1.45
500~550V	0.70	0.72	1.00	1.30	1.40

Jamicon Series : HS

Teapo Series : LG

STANDARD RATINGS

Rated Voltage (SurageVoltage) (V)	Cap (μF)	Case size Φ DxL(mm)	tan δ	Ripple current (A/rms105°C) (120Hz)	Rated Voltage (SurageVoltage) (V)	Cap (μF)	Case size Φ DxL(mm)	tan δ	Ripple current (A/rms105°C) (120Hz)		
6.3 (8)	12000	22x25	0.60	1.55	16 (20)	18000	22x45	0.50	2.90		
		22x30	0.60	1.70			25x40	0.50	2.90		
	15000	25x25	0.60	1.70			30x30	0.50	2.90		
		18000	22x30	0.60			1.95	35x25	0.50	2.95	
	25x25		0.60	1.95			22000	25x45	0.50	3.30	
	22000	22x35	0.60	2.25				30x35	0.50	3.30	
		25x30	0.60	2.25		27000	35x30	0.50	3.30		
	27000	30x25	0.60	2.25			25x50	0.50	3.80		
		22x40	0.60	2.55			30x40	0.50	3.75		
		25x35	0.60	2.55		35x30	0.50	3.75			
	33000	30x30	0.60	2.55		33000	30x45	0.50	4.30		
			0.60	2.55			35x35	0.50	4.25		
			0.60	2.90		39000	30x50	0.60	4.80		
		25x40	0.60	2.95			35x40	0.60	4.80		
		39000	30x30	0.60		2.90	47000	35x45	0.60	5.45	
	35x25		0.60	2.95		56000		35x45	0.60	5.65	
	25x50		0.60	3.25		68000	35x50	0.60	6.20		
	10 (13)	47000	30x35	0.60		3.25	25 (32)	4700	22x25	0.40	1.50
			35x30	0.60		3.30			22x30	0.40	1.65
		56000	25x50	0.60		3.70		5600	25x25	0.40	1.65
30x40			0.60	3.70	22x30	0.40			1.85		
68000		30x45	0.60	4.15	6800	25x25		0.40	1.85		
		35x35	0.60	4.10		8200		22x35	0.40	2.10	
82000		30x50	0.60	4.70	10000			25x30	0.40	2.10	
		35x40	0.60	4.70		30x25		0.40	2.15		
16 (20)		10000	35x45	0.60	5.30	35 (44)		10000	22x40	0.40	2.40
			10000	25x25	0.55				1.55	25x35	0.40
	12000	22x30	0.55	1.75	12000		30x30	0.40	2.40		
		22x30	0.55	1.90			35x25	0.40	2.40		
	15000	25x25	0.55	1.90	15000		22x45	0.40	2.70		
		18000	22x35	0.55			2.20	25x40	0.40	2.75	
	25x30		0.55	2.25			30x30	0.40	2.70		
	22000	22x40	0.55	2.50	18000		35x25	0.40	2.75		
		25x35	0.55	2.55			25x45	0.40	3.15		
		30x25	0.55	2.45	22000		30x35	0.40	3.15		
	27000	22x50	0.55	2.95			35x30	0.40	3.25		
		33000	25x40	0.55	2.90		27000	25x50	0.40	3.55	
	30x30		0.55	2.85	30x40			0.40	3.55		
	39000	35x25	0.55	2.80	33000		35x35	0.40	3.55		
		25x45	0.55	3.30			30x45	0.40	4.05		
		30x35	0.55	3.30	35x35		0.40	3.80			
	47000	35x30	0.55	3.30	39000		27000	35x45	0.40	4.70	
		25x50	0.55	3.70			33000	35x50	0.40	5.40	
56000	30x40	0.55	3.7	47000	39000	35x45	0.45	5.50			
	35x30	0.55	3.65		47000	35x50	0.45	6.00			
16 (20)	47000	30x45	0.55	4.20	35 (44)	3300	22x25	0.35	1.40		
		35x35	0.55	3.80			22x30	0.35	1.55		
	56000	30x50	0.55	4.65		3900	25x25	0.35	1.55		
		35x40	0.55	4.65			4700	22x35	0.35	1.80	
	68000	35x50	0.55	5.50		5600		25x25	0.35	1.80	
		6800	22x25	0.5			1.55	22x35	0.35	1.95	
	8200	22x30	0.5	1.70		6800	25x30	0.35	1.95		
		25x25	0.5	1.70			30x25	0.35	2.00		
10000	22x30	0.5	1.95	8200	22x40	0.35	2.20				
	25x25	0.5	1.95		25x35	0.35	2.25				
12000	22x35	0.5	2.20		10000	30x30	0.35	2.30			
	25x30	0.5	2.25	35x25		0.35	2.35				
15000	30x25	0.5	2.30	15000	22x50	0.35	2.55				
	22x40	0.5	2.55		25x40	0.35	2.50				
	25x35	0.5	2.60		30x30	0.35	2.75				
	30x30	0.5	2.60		35x25	0.35	2.75				
		35x25	0.5	2.65			25x45	0.35	2.85		

Jamicon Series : HS

Teapo Series : LG

STANDARD RATINGS

Rated Voltage (SurageVoltage) (V)	Cap (μF)	Case size Φ D×L(mm)	tan δ	Ripple current (A/rms105°C) (120Hz)	Rated Voltage (SurageVoltage) (V)	Cap (μF)	Case size Φ D×L(mm)	tan δ	Ripple current (A/rms105°C) (120Hz)
35 (44)	10000	30x35	0.35	2.90	80 (100)	1000	22x30	0.20	1.20
		35x30	0.35	2.95			25x25	0.20	1.20
	12000	25x50	0.35	3.25		1200	22x30	0.20	1.40
		30x40	0.35	3.25			25x25	0.20	1.40
		35x30	0.35	3.15		1500	22x35	0.20	1.60
	15000	30x45	0.35	3.70			25x30	0.20	1.60
		35x35	0.35	3.65		30x25	0.20	1.65	
18000	35x40	0.35	4.35	1800		22x40	0.20	1.80	
22000	35x50	0.35	4.90			25x35	0.20	1.85	
50 (63)	1800	22x25	0.30	1.30		2200	22x45	0.20	2.05
		22x30	0.30	1.55			25x35	0.20	2.00
	2200	25x25	0.30	1.55		2700	30x30	0.20	2.05
		22x30	0.30	1.70			35x25	0.20	2.05
	25x25	0.30	1.70	2700			25x45	0.20	2.35
	3300	22x35	0.30			1.95	30x35	0.20	2.35
		25x30	0.30	1.85		35x30	0.20	2.35	
	3900	22x40	0.30	2.15		3300	25x50	0.20	2.70
		25x35	0.30	2.20	30x40		0.20	2.70	
		30x25	0.30	1.95	35x30	0.20	2.55		
	4700	22x45	0.30	2.45	3900	30x45	0.25	3.00	
		25x40	0.30	2.45		35x35	0.25	3.00	
		30x30	0.30	2.45	4700	30x50	0.25	3.40	
		35x25	0.30	2.50		35x40	0.25	3.40	
	5600	22x50	0.30	2.75	5600	35x45	0.25	3.80	
		25x40	0.30	2.70	6800	35x50	0.25	3.90	
		30x35	0.30	2.75	560	22x25	0.20	1.05	
6800	25x50	0.30	3.30	680	22x25	0.20	1.20		
	30x40	0.30	3.30	820	22x30	0.20	1.30		
	35x30	0.30	3.25		25x25	0.20	1.33		
	8200	30x45	0.35	3.60	1000	22x35	0.20	1.50	
		35x35	0.35	3.55		25x30	0.20	1.50	
	10000	30x50	0.35	4.05	1200	22x40	0.20	1.70	
		35x40	0.35	4.00		25x35	0.20	1.70	
12000	35x45	0.35	4.55	1500	30x25	0.20	1.70		
63 (79)	1200	22x25	0.25		1.20	22x45	0.20	1.95	
	1500	22x30	0.25	1.30	25x40	0.20	2.00		
		25x25	0.25	1.30	30x30	0.20	1.95		
	1800	22x30	0.25	1.50	35x25	0.20	2.00		
		25x25	0.25	1.50	1800	25x45	0.20	2.20	
	2200	22x35	0.25	1.70		30x35	0.20	2.50	
		25x30	0.25	1.75	35x30	0.20	2.45		
		30x25	0.25	1.80	2200	25x50	0.20	2.55	
	2700	22x40	0.25	2.00		30x40	0.20	2.70	
		25x35	0.25	2.00	35x30	0.20	2.55		
	3300	30x25	0.25	1.95	2700	30x45	0.20	2.90	
		22x50	0.25	2.30		35x35	0.20	2.85	
		25x40	0.25	2.30	3300	30x50	0.20	3.25	
	30x30	0.25	2.25	35x40		0.20	3.25		
	3900	35x25	0.25	2.10	3900	35x45	0.25	3.70	
		25x45	0.25	2.55		4700	35x50	0.25	3.80
		30x35	0.25	2.55	160 (200)	220	22x20	0.15	0.80
35x30	0.25	2.55	270	22x25		0.15	1.00		
4700	25x50	0.25	2.85	330		22x25	0.15	1.20	
	30x40	0.25	2.85			25x20	0.15	1.15	
5600	35x30	0.25	2.80	390		22x30	0.15	1.30	
	30x45	0.25	3.20			25x25	0.15	1.30	
6800	35x35	0.25	3.20	470		22x30	0.15	1.30	
	30x50	0.25	3.65			22x35	0.15	1.40	
35x40	0.25	3.65	25x25			0.15	1.40		
8200	35x45	0.35	3.90	560		22x40	0.15	1.50	
10000	35x50	0.35	4.40			25x30	0.15	1.50	
80 (100)	820	22x25	0.20	1.10		30x25	0.15	1.50	

Jamicon Series : HS

Teapo Series : LG

STANDARD RATINGS

Rated Voltage (SurageVoltage) (V)	Cap (μF)	Case size Φ D×L(mm)	tan δ	Ripple current (A/rms105°C) (120Hz)	Rated Voltage (SurageVoltage) (V)	Cap (μF)	Case size Φ D×L(mm)	tan δ	Ripple current (A/rms105°C) (120Hz)
160 (200)	680	22x45	0.15	1.70	200 (250)	270	22x25	0.15	0.94
		25x35	0.15	1.70			25x25	0.15	1.00
	820	22x50	0.15	1.95		330	22x30	0.15	1.20
		25x40	0.15	2.00			25x25	0.15	1.20
		30x30	0.15	2.00		390	22x30	0.15	1.30
		35x25	0.15	1.90			22x35	0.15	1.31
	1000	25x45	0.15	2.20		25x30	0.15	1.30	
		30x35	0.15	2.20		30x25	0.15	1.30	
		35x30	0.15	2.20		470	22x35	0.15	1.40
	1200	25x50	0.15	2.45			22x40	0.15	1.52
		30x40	0.15	2.45			25x30	0.15	1.45
	1500	35x30	0.15	2.45		30x25	0.15	1.50	
		30x45	0.15	2.88		560	22x45	0.15	1.75
	1800	35x35	0.15	2.84			25x35	0.15	1.68
2200		30x50	0.15	3.30	30x30	0.15	1.76		
	35x45	0.15	3.30	680	22x50	0.15	2.02		
35x50	0.15	3.75	25x40		0.15	1.96			
180 (225)	180	22x20	0.15	0.75	35x25	0.15	1.98		
	220	22x25	0.15	0.85	820	25x45	0.15	2.27	
	270	22x25	0.15	0.95		30x35	0.15	2.26	
		25x20	0.15	0.90	35x30	0.15	2.33		
	330	22x25	0.15	1.20	1000	25x50	0.15	2.63	
		22x30	0.15	1.22		30x40	0.15	2.64	
	25x25	0.15	1.25	35x30		0.15	2.58		
	390	22x30	0.15	1.30	35x35	0.15	3.00		
		25x25	0.15	1.30	1200	30x45	0.15	3.04	
	470	22x30	0.15	1.30		35x40	0.15	3.16	
		22x35	0.15	1.35	1500	35x45	0.15	3.58	
		25x30	0.15	1.40	1800	35x50	0.15	4.10	
	560	22x40	0.15	1.50	250 (300)	120	22x20	0.15	0.60
		25x35	0.15	1.55		150	22x25	0.15	0.65
	30x25	0.15	1.50	180		22x25	0.15	0.80	
	680	22x45	0.15			1.70	25x20	0.15	0.75
		22x50	0.15	1.70		220	22x30	0.15	0.95
		25x35	0.15	1.70			25x25	0.15	0.95
		25x40	0.15	1.75		270	22x35	0.15	1.15
	30x30	0.15	1.70	25x30			0.15	1.15	
	35x25	0.15	1.70	30x25			0.15	1.15	
	820	22x50	0.15	1.95		330	22x35	0.15	1.19
		25x40	0.15	2.00			25x30	0.15	1.20
		25x45	0.15	2.00			30x25	0.15	1.25
		30x35	0.15	2.00		390	22x40	0.15	1.41
	35x25	0.15	1.90	25x35			0.15	1.50	
	1000	25x45	0.15	2.20		470	30x25	0.15	1.35
		25x50	0.15	2.20			22x50	0.15	1.66
		30x35	0.15	2.25	25x40		0.15	1.61	
		30x40	0.15	2.25	30x30	0.15	1.59		
	1200	35x30	0.15	2.25	35x25	0.15	1.63		
		25x50	0.15	2.45	25x45	0.15	1.85		
		30x40	0.15	2.45	560	30x35	0.15	1.85	
		30x45	0.15	2.50		35x25	0.15	1.78	
	1500	35x35	0.15	2.50	680	25x50	0.15	2.14	
		30x45	0.15	2.80		30x35	0.15	2.04	
30x50		0.15	2.90	35x30		0.15	2.10		
1800	35x40	0.15	2.90	820	30x45	0.15	2.49		
	30x50	0.15	3.30		35x35	0.15	2.45		
2200	35x50	0.15	3.30	1000	35x40	0.15	2.86		
	35x50	0.15	3.60	1500	35x50	0.15	3.68		
200 (250)	150	22x20	0.15	0.65	350 (400)	56	22x20	0.15	0.40
	180	22x20	0.15	0.70		68	22x25	0.15	0.45
	220	22x25	0.15	0.85		82	22x25	0.15	0.55
		25x20	0.15	0.80		25x20	0.15	0.50	

Jamicon Series : HS

Teapo Series : LG

■ STANDARD RATINGS

Rated Voltage (SurageVoltage) (V)	Cap (μF)	Case size Φ DxL(mm)	tan δ	Ripple current (A/rms105°C) (120Hz)	Rated Voltage (SurageVoltage) (V)	Cap (μF)	Case size Φ DxL(mm)	tan δ	Ripple current (A/rms105°C) (120Hz)	
350 (400)	100	22x30	0.15	0.70	400 (450)	470	30x50	0.15	2.05	
		25x25	0.15	0.70			35x45	0.15	2.07	
	120	22x30	0.15	0.65			560	35x45	0.15	2.20
		25x25	0.15	0.70				30x60	0.15	2.33
	30x25	0.15	0.75	35x50				0.15	2.36	
	150	22x35	0.15	0.68			680	35x50	0.15	2.47
		25x30	0.15	0.67		35x60		0.15	2.67	
		30x25	0.15	0.85		420(470)		150	22x35	0.20
	180	22x40	0.15	0.85			22x40		0.20	0.65
		25x35	0.15	0.90			180	25x30	0.20	0.70
	220	30x30	0.15	0.90				22x40	0.20	0.68
		22x50	0.15	1.05			220	25x35	0.20	0.68
		25x40	0.15	1.05				25x40	0.20	0.85
	270	30x30	0.15	1.00			270	25x45	0.20	0.95
		35x25	0.15	1.05				30x40	0.20	0.95
		25x45	0.15	1.20				330	25x45	0.20
	330	30x35	0.15	1.20			30x40		0.20	1.05
		35x30	0.15	1.20			25x50		0.20	1.15
390	30x40	0.15	1.35	390	30x40		0.20	1.15		
	35x35	0.15	1.40		35x35	0.20	1.15			
470	30x45	0.15	1.50	390	30x45	0.20	1.25			
560	35x35	0.15	1.50	470	30x50	0.20	1.40			
400 (450)	47	35x40	0.15	1.70	450 (500)	47	30x50	0.20	1.35	
		35x45	0.15	1.90			35x45	0.20	1.65	
	56	22x20	0.15	0.35		56	22x25	0.20	0.39	
		22x20	0.15	0.40			22x25	0.20	0.42	
	68	22x25	0.15	0.50		68	22x30	0.20	0.50	
		25x20	0.15	0.50			25x25	0.20	0.50	
	82	22x25	0.15	0.52		82	22x30	0.20	0.52	
		22x30	0.15	0.60			22x35	0.20	0.59	
		25x25	0.15	0.65			25x30	0.20	0.60	
	100	22x30	0.15	0.61		100	30x25	0.20	0.58	
		22x35	0.15	0.65			22x30	0.20	0.63	
		25x25	0.15	0.65			22x40	0.20	0.69	
	120	22x30	0.15	0.7		120	25x30	0.20	0.65	
		22x35	0.15	0.72			30x25	0.20	0.68	
		25x30	0.15	0.73			22x35	0.20	0.76	
		30x25	0.15	0.75			22x45	0.20	0.80	
	150	22x35	0.15	0.81		150	25x35	0.20	0.77	
		22x40	0.15	0.85			30x30	0.20	0.80	
25x30		0.15	0.85	35x25	0.20		0.82			
25x35		0.15	0.86	22x40	0.20		0.86			
30x30		0.15	0.90	22x50	0.20		0.90			
35x25		0.15	0.86	25x40	0.20		0.91			
180	22x40	0.15	0.92	180	30x30	0.20	0.92			
	22x50	0.15	1.03		35x25	0.20	0.99			
	25x40	0.15	1.00		22x45	0.20	0.92			
220	30x30	0.15	0.99	220	25x45	0.20	1.03			
	25x45	0.15	1.17		30x35	0.20	1.05			
	30x35	0.15	1.16		35x30	0.20	1.08			
270	35x30	0.15	1.20	270	22x50	0.20	1.12			
	22x35	0.15	0.81		25x50	0.20	1.20			
	22x40	0.15	0.85		30x40	0.20	1.22			
330	25x30	0.15	0.85	330	35x30	0.20	1.20			
	25x35	0.15	0.86		25x50	0.20	1.36			
	30x30	0.15	0.90		30x45	0.20	1.40			
390	35x25	0.15	0.86	390	35x35	0.20	1.42			
	22x40	0.15	0.92		30x45	0.20	1.61			
	22x50	0.15	1.03		30x50	0.20	1.65			
470	25x40	0.15	1.00	470	35x40	0.20	1.68			
	30x30	0.15	0.99		30x50	0.20	1.86			
	35x25	0.15	0.99		35x45	0.20	1.89			

Jamicon Series : HS

Teapo Series : LG

■ STANDARD RATINGS

Rated Voltage (SurageVoltage) (V)	Cap (μ F)	Case size Φ DxL(mm)	$\tan \delta$	Ripple current (A/rms105°C) (120Hz)	Rated Voltage (SurageVoltage) (V)	Cap (μ F)	Case size Φ DxL(mm)	$\tan \delta$	Ripple current (A/rms105°C) (120Hz)
450 (500)	470	35x45	0.20	1.95	500 (550)	390	35x50	0.25	1.78
		35x50	0.20	1.98		470	35x60	0.25	2.03
	560	35x50	0.20	2.03	550(600)	47	22x30	0.25	0.55
		35x60	0.20	2.10		56	22x35	0.25	0.64
500 (550)	47	22x25	0.25	0.51		68	25x30	0.25	0.71
	56	22x30	0.25	0.58		82	22x40	0.25	0.82
	68	25x25	0.25	0.65			25x35	0.25	0.83
	82	22x35	0.25	0.72		100	22x45	0.25	0.86
		25x30	0.25	0.74			30x30	0.25	0.85
	100	22x40	0.25	0.76		120	22x50	0.25	0.95
		30x25	0.25	0.82			25x40	0.25	0.92
	120	22x50	0.25	0.93			30x35	0.25	0.96
		25x35	0.25	0.93		150	25x45	0.25	1.08
	150	30x30	0.25	0.91			30x40	0.25	1.12
		25x45	0.25	1.08		35x30	0.25	1.10	
		30x35	0.25	1.04		180	25x50	0.25	1.20
	35x25	0.25	0.99	30x45			0.25	1.23	
	180	25x50	0.25	1.20		35x35	0.25	1.21	
		30x40	0.25	1.17		220	30x50	0.25	1.42
		35x30	0.25	1.10			35x40	0.25	1.41
220	30x45	0.25	1.33	270		30x50	0.25	1.57	
	35x35	0.25	1.23			35x45	0.25	1.64	
270	30x50	0.25	1.50	330	35x50	0.25	1.73		
	35x40	0.25	1.42	390	35x60	0.25	1.92		
330	35x45	0.25	1.60						

Jamicon Series : LT

Teapo Series : LF Long Life Series

- Endurance:85°C 3000hours
- Recommended Applications : Smoothing circuit, TV/Monitor, Adapter, SMPS
- Corresponding product to RoHS

550V
LINE
UP



DC≤500V I=I 3 CV I≤0.02CVor 3mA whichever is greater. (After rated voltage applied for 5m

■ SPECIFICATIONS

Item	Characteristics															
Category Temperature Range	-40 ~ +85°C				-40 ~ +85°C				-25 ~ +85°C							
Rated Voltage Range	10 ~ 100VDC				160 ~ 500VDC				DC > 500V							
Rated Capacitance Range	820 ~ 56000 μF				56 ~ 2200 μF				47 ~ 390 μF							
Capacitance Tolerance	± 20 % (120Hz ,															
Leakage Current (20°C)	DC≤500V I = 3 √CV DC > 500V I=0.02CVor 3mA whichever is greater . (After rated voltage applied for 5 minutes) I : Max. leakage current (μ A), C : Nominal capacitance (μ F), V : Rated voltage (V)															
Dissipation Factor(MAX) (tan δ) (120Hz ,20°C)	WV	10~16	25	35	50	63	80	100	160~400	420~450	500~550					
	Capacitance	-	-	≤22000	≥37000	≤6800	≥8200	≤6800	≥8200	≤2200	≥2700	≤3300	≥3900	-	-	-
	tan δ	0.50	0.40	0.35	0.40	0.30	0.35	0.25	0.35	0.20	0.25	0.20	0.25	0.15	0.20	0.25
Low Temperature Stability Impedance Ratio (MAX)	Measurement frequency : 120Hz															
	WV	10~16	25	35	50~63	80~100	160~400	420~450	500~550							
	Z-25°C / Z+20°C	4	3	3	2	2	4	8	8							
Z-40°C / Z+20°C	15	10	8	6	5	-	-	-								
Endurance	After applying rated voltage with rated Ripple current for 3000hrs at 85°C, the capacitor shall meet the following requirement.															
	Capacitance change	Within ± 20% of initial value														
	D.F. (tan δ)	not more than 200% of specified value														
	Leakage current	initial specified value or less														
Shelf Life	The following specifications shall be satisfied when the capacitors are restored to 20°C after exposing them for 1,000 hours at 85°C without voltage applied. Before the measurement, the capacitor shall be preconditioned by applying voltage according to item 4.1 of JIS C 5101-4.															

■ Dimensions [mm]

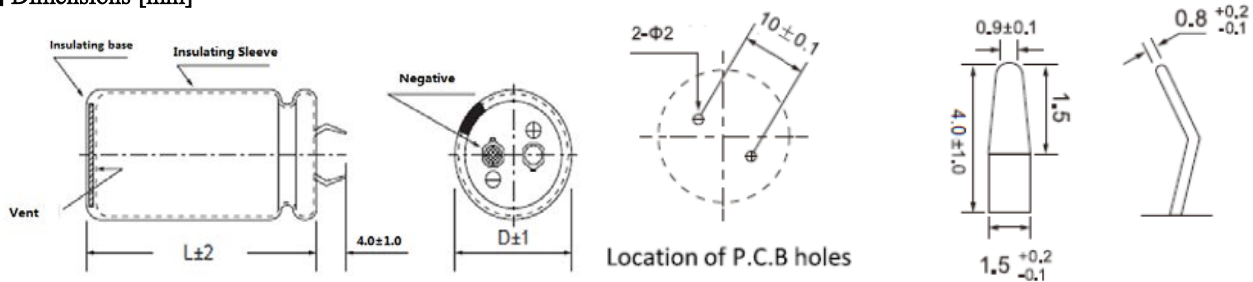

※When the code 11~13 of part number is S1G, the terminal length of standard capacitor is 4.0±1.0mm, and when it is S1A, the terminal length of standard capacitor is 5.8±1.0mm.

■ Multiplier for Ripple Current

Freq. (Hz)	50	60	120	1K	1K~100K
6.3~100V	0.88	0.90	1.00	1.20	1.20
160~250V	0.75	0.78	1.00	1.30	1.50
350~450V	0.74	0.76	1.00	1.35	1.45
500~550V	0.72	0.74	1.00	1.30	1.40

Jamicon Series : LT

Teapo Series : LF

■ STANDARD RATINGS

Rated Voltage (Surge Voltage) (V)	Cap (μF)	Case size Φ D x L (mm)	Ripple current (A/rms85°C) (120Hz)	ESR (Ω,20°C) (120Hz)	Rated Voltage (Surge Voltage) (V)	Cap (μF)	Case size Φ D x L (mm)	Ripple current (A/rms85°C) (120Hz)	ESR (Ω,20°C) (120Hz)
10(13)	12000	22x25	2.45	0.055	25(32)	22000	30x45	4.90	0.024
	15000	22x30	2.80	0.044			35x35	4.85	0.024
	18000	22x35	3.34	0.037			27000	30x50	5.45
		25x25	3.15	0.037		35x40		5.45	0.020
	22000	22x40	3.67	0.030		33000	35x45	6.15	0.016
		25x30	3.50	0.030		35(44)	3900	22x25	2.10
		30x25	3.60	0.030	4700		22x30	2.41	0.099
	22x45		4.12	0.025			25x25	2.30	0.099
	27000	25x35	4.00	0.025	5600		22x35	2.60	0.083
		30x30	4.16	0.025			25x30	2.62	0.083
		22x50	4.63	0.020			30x25	2.70	0.083
	33000	25x40	4.49	0.020	6800		35x25	2.99	0.083
		30x30	4.45	0.020			22x40	2.90	0.068
		35x25	4.54	0.020			25x35	2.93	0.068
	39000	25x45	4.90	0.017	8200		30x30	3.07	0.068
		30x35	4.90	0.017			35x25	3.13	0.068
		35x30	5.05	0.017			22x45	3.30	0.057
	47000	25x50	5.55	0.014	10000	25x35	3.20	0.057	
30x40		5.61	0.014	30x30		3.33	0.057		
35x30		5.50	0.014	35x25		3.42	0.057		
56000	30x45	6.11	0.012	12000	22x50	3.74	0.046		
	35x35	6.05	0.012		25x40	3.64	0.046		
16(20)	8200	22x25	2.45		0.081	30x30	3.60	0.046	
	10000	22x30	2.81	0.066	35x25	3.67	0.046		
	12000	22x35	3.10	0.055	15000	25x45	4.00	0.039	
		25x25	2.90	0.055		30x35	4.00	0.039	
	22x40	3.46	0.044	35x30		4.12	0.039		
	15000	25x30	3.30	0.044	18000	30x40	4.60	0.031	
		30x25	3.40	0.044		35x35	4.47	0.031	
		22x45	3.81	0.037	30x45	5.10	0.026		
	18000	25x35	3.70	0.037	35x40	5.30	0.026		
		30x30	3.85	0.037	22000	35x45	5.70	0.021	
		22x50	4.32	0.030	27000	35x50	6.45	0.020	
	22000	25x45	4.40	0.030	50(63)	2200	22x25	1.92	0.181
		30x30	4.15	0.030		2700	22x30	1.95	0.147
		35x25	4.23	0.030		3300	22x35	2.33	0.121
	25x45	4.65	0.025	25x25			2.24	0.121	
	27000	30x35	4.65	0.025		3900	22x40	2.52	0.102
		35x30	4.79	0.025			25x30	2.40	0.102
		30x40	5.25	0.020		4700	22x45	2.78	0.085
	35x35	5.67	0.020	25x35			2.70	0.085	
	30x45	5.86	0.017	30x30			2.82	0.085	
39000	35x35	5.80	0.017	5600		35x25	2.89	0.085	
	47000	35x40	6.45			0.014	25x35	3.00	0.071
25(32)	5600	22x25	2.20			0.095	6800	30x30	3.12
	6800	22x30	2.69	0.078	35x25	3.21		0.071	
		25x25	2.56	0.078	25x40	3.35		0.059	
	8200	22x35	2.75	0.065	8200	30x35	3.52	0.059	
		25x30	2.75	0.065		35x30	3.62	0.059	
	10000	22x40	3.25	0.053		25x50	3.74	0.057	
		25x30	3.10	0.053	30x40	3.77	0.057		
		30x25	3.19	0.053	35x30	3.70	0.057		
	12000	22x45	3.50	0.044	10000	30x45	4.24	0.046	
		25x35	3.40	0.044		35x35	4.20	0.046	
		30x30	3.54	0.044		30x50	4.65	0.039	
		35x25	3.64	0.044	12000	35x40	4.65	0.039	
	15000	25x45	3.90	0.035	15000	35x45	5.30	0.031	
		30x40	4.10	0.035	18000	35x50	5.90	0.026	
		35x30	4.21	0.035	63(79)	1800	22x25	1.80	0.184
	25x45	4.30	0.029	2200		225x30	2.00	0.151	
	30x40	4.51	0.029			25x25	2.00	0.151	
	18000	35x30	4.39	0.029	2700	22x35	2.30	0.123	

Jamicon Series : LT

Teapo Series : LF

■ STANDARD RATINGS

Rated Voltage (SurageVoltage) (V)	Cap (μF)	Case size Φ DxL(mm)	Ripple current (A/rms85°C) (120Hz)	ESR (Ω,20°C) (120Hz)	Rated Voltage (SurageVoltage) (V)	Cap (μF)	Case size Φ DxL(mm)	Ripple current (A/rms85°C) (120Hz)	ESR (Ω,20°C) (120Hz)		
63(79)	2700	25x30	2.30	0.123	100(125)	2200	35x25	3.11	0.121		
		22x40	2.68	0.100			2700	25x45	3.45	0.098	
	3300	25x30	2.55	0.100		3300		30x35	3.45	0.098	
		30x25	2.63	0.100			25x50	3.94	0.080		
		22x45	2.88	0.085			3900	30x40	3.98	0.080	
	3900	25x35	2.80	0.085		35x30		3.90	0.080		
		30x30	2.91	0.085		3900		30x45	4.34	0.085	
		4700	22x50	3.28			0.071	35x35	4.30	0.085	
	25x40		3.18	0.071			4700	35x40	4.75	0.071	
	30x30		3.15	0.071		5600		35x50	5.30	0.059	
	35x25	3.21	0.071	6800				22x25	1.15	0.603	
	5600	25x45	3.50				0.059	390	22x30	1.30	0.510
		30x35	3.50			0.059	470	22x35	1.59	0.423	
		35x30	3.60	0.059		25x30		1.62	0.423		
	6800	25x50	3.94	0.049		560		22x35	1.99	0.355	
		30x40	3.98	0.049			25x30	2.23	0.355		
35x30		3.90	0.049	680	22x40		2.32	0.293			
8200	30x45	4.39	0.057		25x35	2.24	0.293				
	35x35	4.35	0.057		30x25	2.29	0.293				
	10000	30x50	4.90	0.046	820	22x50	2.32	0.243			
35x40		4.90	0.046	25x40		2.28	0.243				
12000		35x50	5.45	0.039		30x30	2.70	0.243			
	80(100)	1200	22x25	1.70	0.221	160(200)	25x45	2.58	0.199		
		1500	22x30	1.95	0.177		1000	30x35	2.57	0.199	
25x25			1.95	0.177	35x30			2.65	0.199		
1800		22x35	2.15	0.147	1200		25x50	2.78	0.166		
		25x30	2.15	0.147			30x40	2.80	0.166		
2200		22x40	2.57	0.121	1500		35x35	2.92	0.166		
		25x30	2.45	0.121			30x45	3.03	0.133		
		30x25	2.52	0.121			35x40	3.17	0.133		
2700		22x45	2.83	0.123	1800		30x50	3.50	0.111		
		25x35	2.75	0.123			35x45	3.67	0.111		
		30x30	2.86	0.123			2200	35x50	4.08	0.090	
3300		22x50	3.22	0.100	180(225)			270	22x25	1.25	0.737
		3900	25x40	3.13			0.100	330	22x25	1.31	0.603
			35x25	3.16			0.100	390	22x30	1.54	0.510
25x45			3.40	0.085			25x25		1.54	0.510	
4700		30x35	3.40	0.085			470	22x30	1.69	0.423	
	35x30	3.50	0.085	25x25		1.69		0.423			
	25x50	3.84	0.071	560		22x35		1.97	0.355		
5600	30x40	3.88	0.071			25x30	1.99	0.355			
	35x35	4.04	0.071			30x25	2.06	0.355			
	6800	30x45	4.24	0.059		680	22x40	2.30	0.293		
35x40		4.43	0.059	25x35			2.34	0.293			
30x50		4.70	0.049	30x25			2.27	0.293			
8200	35x45	4.93	0.049	820		22x45	2.67	0.243			
	30x50	5.25	0.040			25x40	2.72	0.243			
	100(125)	820	22x25			1.70	0.323	30x30	2.68	0.243	
1000		22x30	1.95	0.265		35x25	2.75	0.243			
		25x25	1.95	0.265	1000	25x45	3.16	0.199			
1200		22x35	2.15	0.221		30x35	3.15	0.199			
		25x30	2.15	0.221	35x30	3.10	0.199				
1500		22x40	2.57	0.177	1200	30x40	3.65	0.166			
		25x30	2.45	0.177		35x30	3.56	0.166			
		30x25	2.52	0.177		1500	30x45	4.15	0.133		
1800		22x45	2.83	0.147	35x35		4.09	0.133			
		25x35	2.75	0.147	1800		35x40	4.73	0.111		
		30x30	2.86	0.147		200(250)	220	22x25	1.25	0.904	
2200		22x50	3.17	0.121			270	25x25	1.33	0.904	
		25x40	3.08	0.121	22x25		1.67	0.737			
		30x30	3.05	0.121	25x25		1.75	0.737			

Jamicon Series : LT

Teapo Series : LF

■ STANDARD RATINGS

Rated Voltage (SurageVoltage) (V)	Cap (μ F)	Case size Φ DxL(mm)	Ripple current (A/rms85°C) (120Hz)	ESR (Ω,20°C) (120Hz)	Rated Voltage (SurageVoltage) (V)	Cap (μ F)	Case size Φ DxL(mm)	Ripple current (A/rms85°C) (120Hz)	ESR (Ω,20°C) (120Hz)		
200(250)	330	22x30	1.66	0.603	315 (365)	330	25x40	1.60	0.603		
		25x25	1.66	0.603			30x35	1.68	0.603		
	390	22x30	1.80	0.510		390	25x45	1.75	0.510		
		25x25	1.80	0.510			30x35	1.75	0.510		
	470	30x25	22x35	2.11		0.423	470	35x30	1.80	0.510	
			25x30	2.13		0.423		30x40	2.00	0.423	
			30x25	2.21		0.423		35x35	2.06	0.423	
	560	22x40	22x40	2.44		0.355	560	30x45	2.20	0.355	
			25x35	2.48		0.355		35x40	2.29	0.355	
			30x25	2.41		0.355		680	35x45	2.50	0.293
	680	22x45	22x45	2.83		0.293	820	35x50	2.80	0.243	
			25x35	2.73		0.293		82	22x25	0.7	2.426
			30x30	2.85		0.293		100	22x25	0.73	1.989
	820	25x40	25x40	3.17		0.243	120	22x30	0.86	1.658	
			30x30	3.13		0.243		25x25	0.86	1.658	
			35x25	3.21		0.243		150	22x30	1.05	1.326
	1000	30x35	30x35	3.68		0.199	25x25		1.05	1.326	
			35x30	3.80		0.199	180	22x35	1.10	1.105	
1200	30x40	30x40	4.26	0.166	25x30	1.14		1.105			
		35x35	4.42	0.166	30x25	1.18	1.105				
1500	35x40	5.02	0.133	350(400)	220	22x40	1.35	0.904			
180	22x25	22x25	1.25			1.105	25x35	1.34	0.904		
		22x25	1.31		0.904	30x25	1.30	0.904			
220	25x25	25x25	1.43		0.904	35x25	1.39	0.904			
		22x30	1.57		0.737	270	25x40	1.57	0.737		
270	25x25	25x25	1.57		0.737		30x30	1.55	0.737		
		22x35	1.85		0.603	35x25	1.59	0.737			
330	25x30	25x30	1.87		0.603	330	25x35	1.67	0.603		
		22x35	2.01		0.510		30x35	1.82	0.603		
390	25x30	25x30	2.03		0.510	390	35x30	1.88	0.603		
		30x25	2.10		0.510		30x40	2.10	0.510		
		22x40	2.34		0.423		35x30	2.04	0.510		
470	25x35	25x35	2.38		0.423	470	30x40	2.30	0.423		
		30x25	2.31		0.423		35x35	2.38	0.423		
		35x25	2.54		0.423	560	35x45	2.74	0.355		
560	25x40	25x40	2.74		0.355	680	35x45	3.18	0.293		
		30x30	2.71		0.355		68	22x25	0.70	2.926	
		35x25	2.78		0.355	82	22x25	0.76	2.426		
680	25x45	25x45	3.19	0.293	100	22x30	0.91	1.989			
		30x35	3.18	0.293		25x25	0.91	1.989			
		35x30	3.28	0.293	120	22x30	1.00	1.658			
820	30x40	30x40	3.69	0.243		25x25	1.00	1.658			
		35x30	3.60	0.243	30x25	1.06	1.658				
1000	30x45	30x45	4.28	0.199	150	22x35	1.19	1.326			
		35x35	4.22	0.199		25x30	1.20	1.326			
1200	35x40	4.88	0.166	180	30x25	1.25	1.326				
100	22x25	22x25	0.75		1.989	22x40	1.38	1.105			
		22x30	0.80	1.658	25x35	1.40	1.105				
315(365)	150	22x30	1.00	1.326	400(450)	30x25	1.37	1.105			
		25x25	1.00	1.326		22x50	1.69	0.904			
	180	25x35	1.10	1.105	220	25x40	1.64	0.904			
		25x30	1.10	1.105		30x30	1.62	0.904			
	220	22x40	22x40	1.31	0.904	35x25	1.66	0.904			
			25x30	1.25	0.904	25x45	1.92	0.737			
			30x25	1.29	0.904	30x35	1.91	0.737			
	270	22x45	22x45	1.44	0.737	270	35x30	1.97	0.737		
			25x35	1.40	0.737		25x50	2.22	0.603		
			30x30	1.46	0.737	330	30x40	2.23	0.603		
			35x25	1.50	0.737		35x30	2.18	0.603		
	330	22x50	1.63	0.603	390	30x45	2.55	0.510			
				35x35		2.52	0.510				

Jamicon Series : LT

Teapo Series : LF

■ STANDARD RATINGS

Rated Voltage (SurageVoltage) (V)	Cap (μ F)	Case size Φ DxL(mm)	Ripple current (A/rms85°C) (120Hz)	ESR (Ω ,20°C) (120Hz)	Rated Voltage (SurageVoltage) (V)	Cap (μ F)	Case size Φ DxL(mm)	Ripple current (A/rms85°C) (120Hz)	ESR (Ω ,20°C) (120Hz)	
400(450)	470	35x40	2.92	0.423	500(550)	120	25x40	1.19	2.763	
	560	35x45	3.34	0.355			30x30	1.17	2.763	
450(500)	56	22x25	0.65	4.737		150	25x45	1.40	2.210	
	68	22x30	0.75	3.901				30x35	1.40	2.210
	82	22x30	0.85	3.235					35x25	1.35
		25x25	0.85	3.235		180	25x50	1.61		1.842
	100	22x35	0.97	2.653			30x40	1.62	1.842	
		25x30	0.98	2.653			35x30	1.58	1.842	
		120	22x40	1.13		2.210	30x45	1.75	1.507	
	25x30		1.08	2.210		35x35	1.72	1.507		
	30x25		1.12	2.210		270	30x50	1.88	1.228	
	150	22x45	1.33	1.768			35x40	1.85	1.228	
		25x35	1.28	1.768	330	35x45	1.98	1.005		
		30x30	1.34	1.768		35x50	2.19	0.850		
	470(500)	180	25x40	1.49	1.474	550(600)	47	22x30	0.64	7.055
			30x30	1.47	1.474		56	22x35	0.74	5.921
			35x25	1.50	1.474		68	22x40	0.87	4.876
		220	25x45	1.73	1.206		82	22x45	1.00	4.044
			30x35	1.72	1.206			25x35	0.97	4.044
			35x30	1.78	1.206		100	22x50	1.16	3.316
270		30x40	2.02	0.982	25x40			1.13	3.316	
		35x35	2.10	0.982	30x30			1.11	3.316	
		330	30x45	2.35	0.804		120	25x45	1.30	2.763
35x35			2.32	0.804	30x35			1.30	2.763	
390		35x40	2.66	0.680	150		25x50	1.46	2.210	
470		35x45	3.07	0.564			30x40	1.47	2.210	
	35x45	3.07	0.564	35x30			1.44	2.210		
500(550)	56	22x30	0.70	5.921	180		30x45	1.70	1.842	
	68	22x35	0.82	4.876			35x35	1.67	1.842	
	82	22x40	0.96	4.044	220		30x50	1.79	1.507	
		25x30	0.91	4.044			35x40	1.77	1.507	
	100	22x45	1.11	3.316	270		35x45	2.11	1.228	
		25x35	1.07	3.316		330	35x50	2.39	1.005	
120	22x50	1.22	2.763							

Jamicon Series : LB

Teapo Series : GA

Long Life&Large Capacitance



■ Endurance: 85°C 3000hours

■ Recommended Applications : Applying to switching power supply and other industry/ commercial field

■ Corresponding product to RoHS

■ SPECIFICATIONS

Item	Characteristics												
Category Temperature Range	-40~+85°C	-25~+85°C											
Rated Voltage Range	16 ~ 500VDC	> 500 VDC											
Rated Capacitance Range	560 ~ 270000 μF	330 ~ 1200 μF											
Capacitance Tolerance	± 20 % (120Hz , 20°C)												
Leakage Current (20°C)	DC≤500V I = 3 √V DC> 500V I=0.02CV or 3mA whichever is greater (After rated voltage applied for 5 minutes) I : Max. leakage current (μ A), C : Nominal capacitance (μ F), V : Rated voltage (V)												
Dissipation Factor(MAX) (tan δ) (120Hz , 20°C)	WV	16	25	35	50	63	80	100	160~450	500~550			
	Capacitance	—	—	—	—	≤27,000	>27,000	≤15,000	>15,000	—			
	tan δ	35 Φ	0.80	0.60	0.50	0.40	0.35	0.40	0.25	0.30	0.25	0.15	0.20
		40 Φ	0.90	0.70	0.60	0.45	0.35	0.40	0.25	0.30	0.25	0.15	0.20
Low Temperature Stability Impedance Ratio (MAX)	Measurement frequency : 120Hz												
	WV	16~100		160~250		350~450		500~550					
	Z-25°C / Z+20°C	4		6		8		8					
	Z-40°C / Z+20°C	15		—		—		—					
Endurance	After applying rated voltage with rated Ripple current for 3000hrs at 85°C ,when the capacitors are restored to 20°C , the capacitor shall meet the following requirements.												
	Capacitance change	Within ± 20% of initial value											
	D.F. (tan δ)	Not more than 200% of specified value											
Shelf Life	The following specifications shall be satisfied when the capacitors are restored to 20°C after exposing them for 1,000 hours at 85°C without voltage applied. Before the measurement, the capacitor shall be preconditioned by applying voltage according to item 4.1 of JIS C 5101-4.												
	Leakage current												

■ Dimensions [mm]

Code 11~13 : S1G(35 Φ)

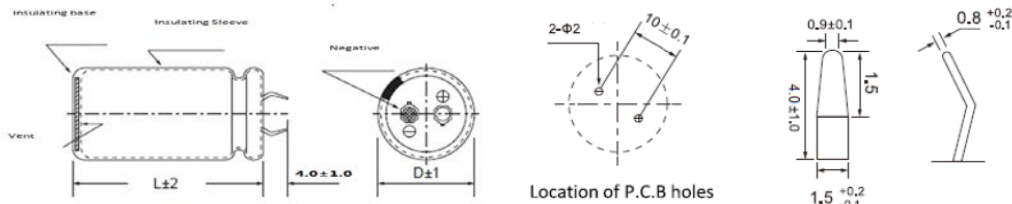

Code 11~13 : L4A(35~45 Φ)

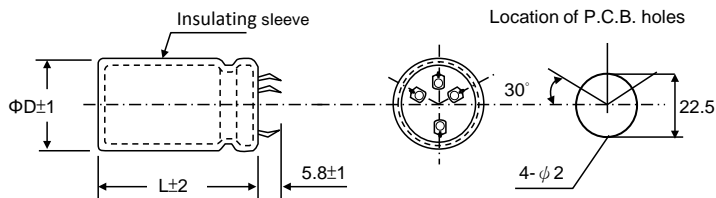

Code 11~13 : L5A(50 Φ)

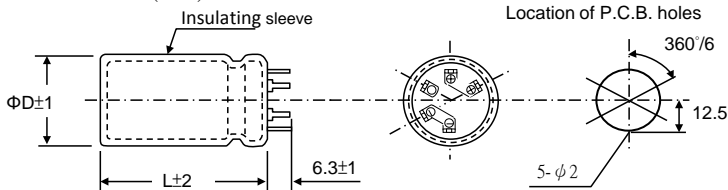

※When the code 11~13 of part number is S1G, the terminal length of standard capacitor is 4.0±1.0mm, and when it is S1A, the terminal length of standard capacitor is 5.8±1.0mm.

■ Multiplier for Ripple Current

Freq. (Hz)	60	120	400	1K	10K
≤100V	0.80	1.00	1.10	1.20	1.20
>100V	0.80	1.00	1.10	1.30	1.40

Jamicon Series : LB

Teapo Series : GA

■ STANDARD RATINGS

Rated Voltage (SurageVoltage) (V)	Cap (μ F)	Case size Φ DxL(mm)	$\tan \delta$	Ripple current (A/rms85°C) (120Hz)	Rated Voltage (SurageVoltage) (V)	Cap (μ F)	Case size Φ DxL(mm)	$\tan \delta$	Ripple current (A/rms85°C) (120Hz)
16 (20)	82000	35x60	0.80	10.25	50 (63)	33000	35x80	0.40	9.41
		45x51	1.00	10.38			40x61	0.45	9.11
	100000	35x80	0.80	11.15			45x60	0.50	9.18
		40x61	0.90	11.60			50x50	0.55	10.73
		45x50	1.00	10.84			35x90	0.40	9.99
	120000	35x80	0.80	12.39		40x81	0.45	10.44	
		40x81	0.90	12.47		45x70	0.50	9.92	
		45x60	1.00	11.10		50x60	0.55	11.52	
		50x50	1.20	13.47		35x100	0.40	10.59	
	150000	40x91	0.90	13.55		40x91	0.45	11.18	
		45x70	1.00	12.23		45x70	0.50	10.09	
		50x60	1.20	14.83		50x60	0.55	11.88	
	180000	40x101	0.90	14.92		40x101	0.45	11.77	
		45x80	1.00	13.61		45x90	0.50	11.31	
		50x80	1.20	16.05		50x80	0.55	12.75	
220000	45x90	1.00	15.16	45x100	0.50	12.5			
	50x90	1.20	17.35	50x90	0.55	13.70			
	270000	50x100	1.20	17.81	82000	50x100	0.55	12.50	
25 (32)	56000	35x60	0.60	8.81	63 (79)	15000	35x60	0.35	7.74
		40x51	0.70	9.12			40x51	0.35	8.46
	68000	35x80	0.60	10.62			18000	35x80	0.35
		40x61	0.70	10.48		40x61	0.35	9.47	
		45x50	0.80	9.66		45x50	0.35	9.33	
	82000	35x90	0.60	11.35		22000	35x90	0.35	10.27
		40x71	0.70	11.02		40x71	0.35	9.94	
		45x60	0.80	10.26		45x60	0.35	9.89	
	100000	50x50	1.00	12.54		27000	35x100	0.35	10.44
		35x100	0.60	12.06		40x81	0.35	10.94	
		40x81	0.70	12.41		45x70	0.35	10.97	
		45x70	0.80	11.63		50x50	0.35	11.15	
		50x60	1.00	13.68		40x101	0.40	12.08	
	120000	40x91	0.70	13.75		33000	45x80	0.40	11.62
		45x80	0.80	12.96		50x60	0.40	11.67	
		50x80	1.00	15.38		45x90	0.40	11.93	
	150000	40x101	0.70	14.00		39000	50x70	0.40	12.22
		45x90	0.80	13.36		47000	45x100	0.40	12.67
		50x90	1.00	16.29		50x80	0.40	13.19	
	180000	45x100	0.80	14.61		56000	50x100	0.40	14.05
		50x100	1.00	17.31		80 (100)	10000	35x60	0.25
33000		35x60	0.50	7.97	12000		35x70	0.25	8.26
	35x60	0.50	8.00	40x51	0.25		7.77		
39000	40x51	0.60	8.22	45x50	0.25		8.26		
	35x80	0.50	9.56	15000	35x80		0.25	8.91	
	40x61	0.60	9.74	40x61	0.25		8.52		
47000	45x50	0.70	8.88	45x60	0.25		9.06		
	35x90	0.50	10.53	18000	35x90		0.30	10.34	
	40x81	0.60	10.83	40x81	0.30		10.61		
56000	45x60	0.70	9.76	45x70	0.30		10.64		
	50x50	0.75	10.97	50x50	0.30		10.13		
	35x100	0.50	11.07	22000	35x100		0.30	10.18	
68000	40x91	0.60	11.64	40x91	0.30		10.49		
	45x70	0.70	11.08	45x80	0.30		10.58		
	50x60	0.75	12.23	50x60	0.30		11.36		
	40x101	0.60	12.33	27000	40x101		0.30	11.75	
82000	45x90	0.70	12.07	45x90	0.30		11.90		
	50x80	0.75	13.22	50x80	0.30		12.43		
	45x100	0.70	12.81	33000	45x100		0.30	12.26	
100000	50x90	0.75	14.22	39000	50x90		0.30	13.44	
	50x100	0.75	15.02	100 (125)	6800		35x60	0.25	7.22
120000	35x80	0.40	9.14		8200	40x51	0.25	7.45	
	40x51	0.45	8.16		8200	35x70	0.25	8.07	
50 (63)	27000	45x50	0.50	8.23					

Jamicon Series : LB

Teapo Series : GA

■ STANDARD RATINGS

Rated Voltage (SurageVoltage) (V)	Cap (μ F)	Case size Φ DxL(mm)	$\tan \delta$	Ripple current (A/rms85°C) (120Hz)	Rated Voltage (SurageVoltage) (V)	Cap (μ F)	Case size Φ DxL(mm)	$\tan \delta$	Ripple current (A/rms85°C) (120Hz)
100 (125)	8200	45x61	0.25	8.40	200 (250)	2700	40x61	0.15	5.91
		50x50	0.25	8.28			45x50	0.15	8.83
	10000	35x90	0.25	9.21		3300	35x80	0.15	6.48
		40x71	0.25	8.67			40x61	0.15	6.19
		45x60	0.25	8.63			45x60	0.15	6.58
	12000	50x50	0.25	9.00		3900	50x50	0.15	7.58
		35x100	0.25	8.83			35x90	0.15	7.22
		40x81	0.25	8.92			40x71	0.15	6.99
		45x70	0.25	8.94			45x60	0.15	6.96
	15000	50x60	0.25	10.34		4700	50x60	0.15	8.87
		40x101	0.25	10.30			40x91	0.15	7.84
		45x80	0.25	9.91			45x70	0.15	7.45
	18000	50x70	0.25	10.96		5600	50x70	0.15	9.90
		45x90	0.25	10.25			40x101	0.15	8.13
50x80		0.25	11.12	45x80	0.15		7.82		
22000	50x100	0.25	12.59	50x70	0.15	10.26			
160 (200)	3300	35x60	0.15	6.33	6800	45x90	0.15	8.13	
		40x51	0.15	6.38		50x80	0.15	11.66	
	3900	35x80	0.15	7.43	7500	45x100	0.15	8.26	
		40x61	0.15	7.48		50x90	0.15	12.54	
		45x50	0.15	7.37		50x100	0.15	13.36	
	47000	35x90	0.15	8.38	250 (300)	1800	35x60	0.15	4.56
		40x81	0.15	8.37			40x51	0.15	4.59
		45x60	0.15	7.85		2200	35x80	0.15	5.29
		50x50	0.15	8.40			40x61	0.15	5.06
	5600	35x100	0.15	8.30		2700	45x50	0.15	4.98
		40x81	0.15	8.37			35x80	0.15	5.86
		45x60	0.15	7.86			40x81	0.15	6.34
	6800	50x60	0.15	9.12		3300	45x60	0.15	5.95
		40x101	0.15	8.34			50x50	0.15	6.86
		45x80	0.15	8.02			35x100	0.15	7.17
	8200	50x70	0.15	9.82		3900	40x81	0.15	7.01
		45x90	0.15	8.24			45x70	0.15	7.03
	10000	50x80	0.15	10.04			4700	50x60	0.15
45x100		0.15	8.75	40x101		0.15		8.19	
12000	50x90	0.15	10.46	5600		45x80		0.15	7.87
	50x100	0.15	12.00			50x70	0.15	8.57	
180 (225)	2200	35x60	0.15			5.69	6800	45x90	0.15
		35x70	0.15	5.06		50x80		0.15	9.69
	2700	40x61	0.15	5.14	1000	45x100		0.15	9.82
		35x80	0.15	5.58		50x90	0.15	10.84	
		40x61	0.15	5.68		50x100	0.15	12.16	
	3300	45x50	0.15	5.59	1200	35x60	0.15	3.84	
		35x90	0.15	5.78		40x51	0.15	3.86	
		40x71	0.15	6.56		35x80	0.15	4.67	
	3900	45x60	0.15	6.16	1500	40x61	0.15	4.46	
		50x50	0.15	7.06		45x50	0.15	4.39	
		35x100	0.15	6.18		50x50	0.15	5.22	
	4700	40x81	0.15	6.74	1800	35x80	0.15	5.09	
		45x70	0.15	6.33		40x71	0.15	5.2	
		50x60	0.15	7.89		45x60	0.15	5.18	
	5600	40x101	0.15	7.85	2200	50x60	0.15	6.03	
		45x80	0.15	7.55		35x100	0.15	6.03	
		50x70	0.15	8.37		40x81	0.15	5.90	
	6800	45x90	0.15	8.45	2700	45x80	0.15	6.26	
50x80		0.15	8.51	50x80		0.15	3.97		
8200	45x100	0.15	8.64	400 (450)		40x101	0.15	7.03	
	50x90	0.15	8.74		45x90	0.15	7.12		
10000	50x100	0.15	9.27		50x90	0.15	7.93		
200 (250)	2200	35x60	0.15	5.69	45x100	0.15	8.06		
		40x51	0.15	5.47	50x100	0.15	8.98		
	2700	35x70	0.15	5.83	820	35x60	0.15	3.55	

Jamicon Series : LB

Teapo Series : GA

■ STANDARD RATINGS

Rated Voltage (SurageVoltage) (V)	Cap (μ F)	Case size Φ D \times L(mm)	tan δ	Ripple current (A/rms85°C) (120Hz)	Rated Voltage (SurageVoltage) (V)	Cap (μ F)	Case size Φ D \times L(mm)	tan δ	Ripple current (A/rms85°C) (120Hz)	
400 (450)	820	40x51	0.15	3.58	500(550)	470	45x50	0.20	2.88	
		35x80	0.15	4.26			560	35x80	0.20	3.66
	1000	40x61	0.15	4.26		40x61		0.20	3.13	
		45x50	0.15	4.29		45x60	0.20	3.33		
		50x50	0.15	4.77		50x50	0.20	3.54		
	1200	35x80	0.15	4.56		680	35x80	0.20	3.25	
		40x61	0.15	4.56			40x81	0.20	4.52	
		45x60	0.15	5.07			45x70	0.20	4.53	
		50x60	0.15	5.51			50x60	0.20	4.13	
	1500	35x100	0.15	5.51		820	35x100	0.20	4.04	
		40x81	0.15	5.52			40x81	0.20	3.95	
		45x80	0.15	6.14			45x80	0.20	4.20	
		50x80	0.15	6.66			50x70	0.20	4.57	
	1800	40x101	0.15	6.67		1000	40x101	0.20	4.82	
		45x90	0.15	6.92			45x90	0.20	4.88	
		50x90	0.15	7.51			50x80	0.20	5.13	
2200	45x100	0.15	7.46	1200	45x100	0.20	5.61			
	50x100	0.15	8.50		50x90	0.20	5.79			
					1500	50x100	0.20	6.64		
450(500)	560	35x60	0.15	2.94	550(600)	330	35x60	0.20	2.52	
		35x70	0.15	3.39			40x51	0.20	2.62	
	680	40x51	0.15	3.19		390	35x70	0.20	2.83	
		45x50	0.15	3.39			40x61	0.20	2.97	
		35x80	0.15	3.95			45x50	0.20	2.93	
	820	40x61	0.15	3.77		470	35x80	0.20	3.18	
		45x60	0.15	4.01			40x71	0.20	3.36	
		50x50	0.15	5.04			45x60	0.20	3.35	
		35x90	0.15	4.39			50x60	0.20	3.19	
	1000	40x81	0.15	4.50		560	35x90	0.20	3.52	
		45x70	0.15	4.51			40x81	0.20	3.75	
		50x60	0.15	5.03			45x70	0.20	3.76	
		35x100	0.15	4.80			50x60	0.20	3.61	
	1200	40x81	0.15	4.70		680	35x100	0.20	3.92	
		45x80	0.15	4.99			40x91	0.20	4.19	
		50x80	0.15	5.83			45x80	0.20	4.23	
		40x101	0.15	5.8			50x70	0.20	4.08	
	1500	45x90	0.15	5.88		820	40x101	0.20	4.27	
		50x90	0.15	6.7			45x90	0.20	4.33	
		45x100	0.15	6.75			50x80	0.20	4.55	
	1800	50x100	0.15	7.51		1000	45x100	0.20	4.14	
							50x90	0.20	5.07	
	500(550)	390	35x60	0.20		2.83	1200	50x100	0.20	5.65
			40x51	0.20		2.94				
470		35x60	0.20	2.59						
		40x51	0.20	2.71						

Jamicon Series : LL

Teapo Series : GC Long Life Series

■ Endurance:85°C 5000hours

■ Recommended Applications :UPS、service system、press working equipment、charging equipment、inverter、converter

■ Corresponding product to RoHS



SPECIFICATIONS

Item	Characteristics																		
Category Temperature Range	-40 ~ +85°C																		
Rated Voltage Range	160 ~ 450VDC																		
Capacitance Tolerance	± 20 % (120Hz, 20°C)																		
Leakage Current (20°C)	$I = \sqrt[3]{CV}$. (After rated voltage applied for 5 minutes) I : Max. leakage current (μA), C : Nominal capacitance (μF), V : Rated voltage (V)																		
Dissipation Factor(MAX) (tan δ) (120Hz, 20°C)	<table border="1"> <tr> <td>WV</td> <td>160</td> <td>200</td> <td>250</td> <td>350</td> <td>385</td> <td>400</td> <td>420</td> <td>450</td> </tr> <tr> <td>tan δ</td> <td>0.15</td> <td>0.15</td> <td>0.15</td> <td>0.15</td> <td>0.15</td> <td>0.15</td> <td>0.20</td> <td>0.20</td> </tr> </table>	WV	160	200	250	350	385	400	420	450	tan δ	0.15	0.15	0.15	0.15	0.15	0.15	0.20	0.20
WV	160	200	250	350	385	400	420	450											
tan δ	0.15	0.15	0.15	0.15	0.15	0.15	0.20	0.20											
Low Temperature Stability Impedance Ratio (MAX)	Measurement frequency : 120Hz <table border="1"> <tr> <td>Rated voltage(V)</td> <td>160~250</td> <td>350~450</td> </tr> <tr> <td>Z-25°C / Z+20°C</td> <td>4</td> <td>8</td> </tr> </table>	Rated voltage(V)	160~250	350~450	Z-25°C / Z+20°C	4	8												
Rated voltage(V)	160~250	350~450																	
Z-25°C / Z+20°C	4	8																	
Endurance	After applying rated voltage with rated ripple current for 5000 hours at 85°C , the capacitors shall meet the following requirements. <table border="1"> <tr> <td>Capacitance change</td> <td>Within ± 20% of initial value</td> </tr> <tr> <td>D.F. (tan δ)</td> <td>Not more than200% of specified value</td> </tr> <tr> <td>Leakage current</td> <td>Not more than the specified value</td> </tr> </table>	Capacitance change	Within ± 20% of initial value	D.F. (tan δ)	Not more than200% of specified value	Leakage current	Not more than the specified value												
Capacitance change	Within ± 20% of initial value																		
D.F. (tan δ)	Not more than200% of specified value																		
Leakage current	Not more than the specified value																		
Shelf Life	The following specifications shall be satisfied when the capacitors are restored to 20°C after exposing them for1,000 hours at 85°C without voltage applied. Before the measurement, the capacitor shall be preconditioned by applying voltage according to item 4.1 of JIS C 5101-4.																		

Dimensions [mm]

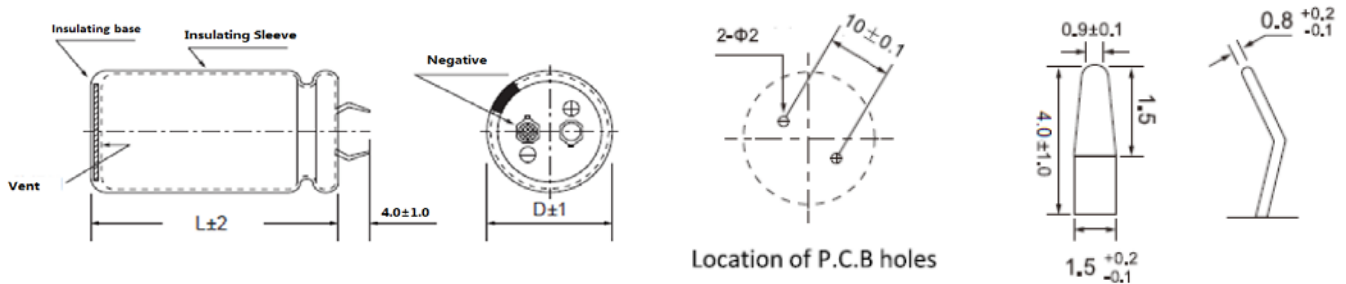

■ 纹波电流修正系数

Freq. (Hz)	60	120	400	1k	10k
WV	0.8	1.00	1.10	1.30	1.40
≥160V	0.8	1.00	1.10	1.30	1.40

Jamicon Series : LL

Teapo Series : GC

■ STANDARD RATINGS

Rated Voltage (SurageVoltage) (V)	Cap (μ F)	Case size Φ DxL(mm)	$\tan \delta$	Ripple current (A/rms 85°C) (120Hz)	Rated Voltage (SurageVoltage) (V)	Cap (μ F)	Case size Φ DxL(mm)	$\tan \delta$	Ripple current (A/rms 85°C) (120Hz)	
160V (200)	220	22x25	0.15	1.13	385V	330	35x30	0.15	1.96	
	330	22x30	0.15	1.44		470	30x50	0.15	2.58	
	470	22x35	0.15	1.85		35x40	0.15	2.58		
		25x30	0.15	1.85		560	35x45	0.15	2.88	
	680	22x45	0.15	2.47		680	35x50	0.15	3.12	
		25x35	0.15	2.47		400V (450)	68	22x25	0.15	0.63
		30x30	0.15	2.47			100	22x30	0.15	0.81
	1000	25x45	0.15	3.19			25x25	0.15	0.82	
		30x35	0.15	3.19			120	22x35	0.15	0.95
	1500	35x30	0.15	3.19			25x30	0.15	0.95	
30x45		0.15	4.33	150	22x40		0.15	1.13		
35x40		0.15	4.33		25x35		0.15	1.13		
2200	35x50	0.17	5.97	30x25	0.15		1.13			
200V (250)	220	22x25	0.15	1.13	180		25x40	0.15	1.24	
	330	22x30	0.15	1.44	30x30		0.15	1.24		
		25x25	0.15	1.55	220	25x40	0.15	1.44		
	470	22x40	0.15	1.96		30x35	0.15	1.55		
		25x30	0.15	1.96	25x45	0.15	1.65			
	680	30x25	0.15	1.96	270	30x35	0.15	1.65		
		25x40	0.15	2.58		35x25	0.15	1.65		
		30x30	0.15	2.47	330	30x45	0.15	2.06		
	1000	30x40	0.15	3.40		35x35	0.15	2.06		
		35x35	0.15	3.61	390	30x50	0.15	2.27		
1500	35x45	0.15	4.74	35x40		0.15	2.27			
250V (300)	150	22x25	0.15	0.94	470	35x45	0.15	2.68		
	220	22x30	0.15	1.24	560	35x50	0.15	2.99		
		25x25	0.15	1.24	420V (470)	100	22x30	0.20	0.81	
	330	22x40	0.15	1.65		25x25	0.20	0.82		
		25x30	0.15	1.65		120	22x40	0.20	0.97	
	470	25x40	0.15	2.16			25x30	0.20	0.97	
		30x30	0.15	2.06		150	22x45	0.20	1.11	
	560	25x45	0.15	2.50			25x35	0.20	1.14	
		30x35	0.15	2.50		30x25	0.20	1.15		
	680	35x25	0.15	2.50		180	22x50	0.20	1.30	
30x40		0.15	2.78	25x35			0.20	1.25		
1000	35x30	0.15	2.78	30x30		0.20	1.30			
	35x40	0.15	3.71	220	25x40	0.20	1.45			
350V (400)	68	22x25	0.15		0.63	30x35	0.20	1.50		
	100	22x30	0.15	0.81	25x50	0.20	1.70			
		25x25	0.15	0.82	270	30x35	0.20	1.67		
	150	22x40	0.15	1.13		35x30	0.20	1.76		
		25x30	0.15	1.03	330	30x45	0.20	2.02		
	220	22x50	0.15	1.11		35x35	0.20	2.04		
		25x40	0.15	1.44	390	30x50	0.20	2.29		
		30x30	0.15	1.44		35x40	0.20	2.29		
	330	25x50	0.15	1.96	470	35x45	0.20	2.66		
		30x40	0.15	1.96	560	35x50	0.20	3.02		
470	35x30	0.15	1.96	450V (500)	47	22x25	0.20	0.53		
	30x50	0.15	2.58		68	22x30	0.20	0.67		
560	35x40	0.15	2.58		25x25	0.20	0.68			
	35x45	0.15	2.88		22x40	0.20	0.91			
680	35x50	0.15	3.12		100	25x30	0.20	0.89		
68	22x25	0.15	0.63			30x25	0.20	0.93		
	100	22x30	0.15		0.81	150	22x50	0.20	1.20	
25x25		0.15	0.82		25x40		0.20	1.24		
150	22x40	0.15	1.03		30x30	0.20	1.13			
	25x30	0.15	1.03		180	25x45	0.20	1.34		
220	22x50	0.15	1.44	30x35		0.20	1.34			
	25x40	0.15	1.44	220	35x30	0.20	1.34			
30x30	0.15	1.44	30x40		0.20	1.55				
330	25x50	0.15	1.96	35x40	0.20	1.55				
	30x40	0.15	1.96	30x45	0.20	1.85				

Jamicon Series : LL

Teapo Series : GC

■ STANDARD RATINGS

Rated Voltage (SurageVoltage) (V)	Cap (μ F)	Case size Φ D \times L(mm)	tan δ	Ripple current (A/rms 85°C) (120Hz)
450V (500)	270	35x35	0.20	1.85
	330	35x40	0.20	2.16

Rated Voltage (SurageVoltage) (V)	Cap (μ F)	Case size Φ D \times L(mm)	tan δ	Ripple current (A/rms 85°C) (120Hz)
450V (500)	470	35x50	0.20	2.78

Jamicon Series : HT

Teapo Series : LJ Long Life Series

- Endurance:105°C 3000 hours
- Recommended Applications : Smoothing circuit, TV/Monitor,Adapter, SMPS
- Corresponding product to RoHS

550V
LINE
UP



■ SPECIFICATIONS

Item	Characteristics										
Category Temperature Range	-40 ~ +105°C			-40 ~ +105°C				-25 ~ +105°C			
Rated Voltage Range	10 ~ 100VDC			160 ~ 500VDC				DC > 500V			
Rated Capacitance Range	560 ~ 68000 µF			56~ 2200 µF				47~ 470 µF			
Capacitance Tolerance	± 20 % (120Hz ,										
Leakage Current (20°C)	DC ≤ 500V I = 3√CV DC > 500V I = 0.02CV or 3mA whichever is greater (After rated voltage applied for 5minutes) I : Max. leakage current (µA), C : Nominal capacitance (µF), V : Rated voltage (V)										
Dissipation Factor(MAX) (tan δ) (120Hz ,20°C)	WV	10~16	25	35	50	63	80~100	160~400	420~450	500~550	
	Capacitance	-	-	-	≤6800	≥8200	≤6800	≥8200	-	-	-
	tan δ	0.5	0.4	0.35	0.3	0.35	0.25	0.35	0.25	0.15	0.20
Low Temperature Stability Impedance Ratio (MAX)	Measurement frequency : 120Hz										
	Rated voltage(V)	10~16	25	35	50~63	80~100	160~400	420~450	500~550		
	Z-25°C / Z+20°C	4	3	3	3	3	4	8	8		
	Z-40°C / Z+20°C	15	10	8	6	6	-	-	-		
Endurance	After applying rated voltage with rated Ripple current for 3000hrs at 105°C, the capacitor shall meet the following requirement.										
	Capacitance change	Within ± 20% of initial value									
	D.F. (tan δ)	Not more than 200% of specified value									
Shelf Life	The following specifications shall be satisfied when the capacitors are restored to 20°C after exposing them for 1,000 hours at 105°C without voltage applied. Before the measurement, the capacitor shall be preconditioned by applying voltage according to item 4.1 of JIS C 5101-4.										

■ Dimensions [mm]

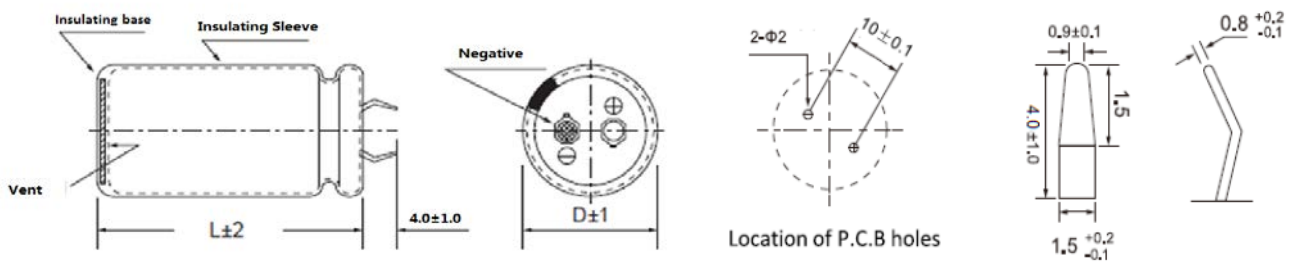

※When the code 11~13 of part number is S1G, the terminal length of standard capacitor is 4.0±1.0mm, and when it is S1A, the terminal length of standard capacitor is 5.8±1.0mm.

■ Multiplier for Ripple Current

Frequency(Hz)	50	60	120	1K	10K~100K
6.3~100V	0.88	0.90	1.00	1.20	1.30
160~250V	0.85	0.88	1.00	1.30	1.50
315~450V	0.88	0.90	1.00	1.35	1.45
500~550V	0.70	0.72	1.00	1.30	1.40

Jamicon Series : HT

Teapo Series : LJ

■ STANDARD RATINGS

Rated Voltage (SurageVoltage) (V)	Cap (μ F)	Case size Φ DxL(mm)	Ripple current (A/rms105°C) (120Hz)	ESR (Ω ,20°C) (120Hz)	Rated Voltage (SurageVoltage) (V)	Cap (μ F)	Case size Φ DxL(mm)	Ripple current (A/rms105°C) (120Hz)	ESR (Ω ,20°C) (120Hz)	
10(13)	10000	22x25	1.80	0.066	25(32)	12000	25x45	3.22	0.044	
	12000	22x30	2.05	0.055			30x35	3.19	0.044	
		25x25	2.05	0.055			35x25	3.10	0.044	
		22x35	2.45	0.044			25x50	3.43	0.035	
	15000	25x30	2.45	0.044		30x40	3.47	0.035		
		3025	2.55	0.044		35x30	3.40	0.035		
		22x40	2.94	0.037		30x45	3.94	0.029		
	18000	25x30	2.80	0.037		35x35	3.90	0.029		
		30x30	3.11	0.037		30x50	4.30	0.024		
		22x45	3.24	0.030		35x40	4.30	0.024		
	22000	25x35	3.15	0.030		27000	35x45	4.85	0.020	
		30x30	3.28	0.030		35(44)	2700	22x25	1.45	0.172
		35x25	3.37	0.030			3300	22x30	1.60	0.141
		27000	25x40	3.50			0.025	3900	22x30	1.80
	30x35		3.67	0.025			4700	22x35	2.23	0.099
	35x30		3.78	0.025				25x25	2.10	0.099
	33000	25x45	4.00	0.020			5600	22x40	2.41	0.083
		30x40	4.20	0.020				25x30	2.30	0.083
		35x30	4.08	0.020			30x25	2.37	0.083	
	39000	25x50	4.45	0.017			6800	22x45	2.68	0.068
30x45		4.67	0.017	25x35	2.60			0.068		
35x35		4.63	0.017	30x30	2.70			0.068		
47000	35x40	4.90	0.014	8200	22x50		3.02	0.057		
56000	35x45	5.50	0.012		25x40		2.93	0.057		
68000	30x50	6.05	0.010		30x30		2.90	0.057		
16(20)	6800	22x25	1.80		0.098		35x25	2.96	0.057	
		22x30	2.05		0.081		10000	25x45	3.20	0.046
	8200	25x25	2.05		0.081			30x35	3.20	0.046
		22x35	2.45		0.066			35x30	3.30	0.046
	10000	25x30	2.45		0.066		12000	25x50	3.64	0.039
		22x40	2.73		0.055			30x40	3.67	0.039
	12000	25x30	2.60		0.055	35x30	3.60	0.039		
		30x25	2.68	0.055	15000	30x45	4.04	0.031		
		22x45	2.99	0.044		35x35	4.00	0.031		
	15000	25x35	2.90	0.044	18000	35x40	4.60	0.026		
		30x30	3.02	0.044	22000	35x50	5.10	0.021		
		22x50	3.43	0.037	50(63)	1500	22x25	1.25	0.265	
	18000	25x40	3.33	0.037		1800	22x30	1.45	0.221	
		30x30	3.30	0.037		2200	22x30	1.60	0.181	
		35x25	3.37	0.037			25x25	1.60	0.181	
	22000	25x45	3.70	0.030		2700	22x35	1.80	0.147	
		30x35	3.70	0.030			25x30	1.80	0.147	
		35x30	3.81	0.030		3300	22x40	2.05	0.121	
	27000	30x40	4.15	0.025			25x30	1.95	0.121	
	35x35	4.27	0.025	30x25			2.01	0.121		
33000	30x50	4.65	0.020	3900		22x45	2.27	0.102		
	35x40	4.65	0.020			25x35	2.20	0.102		
39000	35x45	5.25	0.017			30x30	2.29	0.102		
47000	35x50	5.80	0.014	4700		22x50	2.50	0.085		
25(32)	3900	22x25	1.50			0.136	25x40	2.42	0.085	
	4700	22x30	1.80			0.113	30x30	2.40	0.085	
5600	22x30	1.95	0.095			35x25	2.45	0.085		
	25x25	1.95	0.095			5600	25x45	2.70	0.071	
6800	22x35	2.20	0.078				30x35	2.70	0.071	
	25x30	2.20	0.078				35x30	2.78	0.071	
8200	22x40	2.47	0.065			6800	30x40	3.06	0.059	
	25x35	2.50	0.065		35x30		3.00	0.059		
	30x25	2.45	0.065		8200	30x45	3.38	0.057		
10000	22x45	2.75	0.053	35x35		3.35	0.057			
	25x40	2.80	0.053	35x40	3.70	0.046				
	30x30	2.75	0.053	12000	35x50	4.20	0.039			
12000	22x50	3.13	0.044	63(79)	1200	22x25	1.25	0.276		

Jamicon Series : HT

Teapo Series : LJ

■ STANDARD RATINGS

Rated Voltage (SurageVoltage) (V)	Cap (μ F)	Case size Φ DxL(mm)	Ripple current (A/rms105°C) (120Hz)	ESR (Ω ,20°C) (120Hz)	Rated Voltage (SurageVoltage) (V)	Cap (μ F)	Case size Φ DxL(mm)	Ripple current (A/rms105°C) (120Hz)	ESR (Ω ,20°C) (120Hz)
63(79)	1500	22x30	1.45	0.221	100(125)	2200	25x50	2.75	0.151
		22x25	1.45	0.221			30x40	2.75	0.151
	1800	22x35	1.60	0.184			35x35	2.86	0.151
		25x30	1.60	0.184		2700	30x45	3.08	0.123
	2200	22x40	1.89	0.151			35x35	3.05	0.123
		25x30	1.80	0.151		3300	30x50	3.45	0.100
		30x25	1.85	0.151			35x40	3.45	0.100
	2700	22x45	2.06	0.123		3900	35x45	3.90	0.085
		25x35	2.00	0.123			4700	35x50	4.30
		30x30	2.08	0.123		160(200)	270	22x25	0.85
	3300	25x40	2.32	0.100	330		22x30	1.00	0.603
		30x30	2.30	0.100	390		22x30	1.15	0.510
		35x25	2.35	0.100			25x25	1.15	0.510
	3900	25x45	2.55	0.085	470		22x35	1.30	0.423
		30x35	2.55	0.085			25x30	1.30	0.423
		4700	35x30	2.63	0.085		560	22x40	1.57
	25x50		2.83	0.071	25x30			1.50	0.355
	30x40		2.86	0.071	30x25			1.54	0.355
	5600	35x30	2.80	0.071	680		22x45	1.75	0.293
		30x45	3.18	0.059		25x35	1.70	0.293	
35x35		3.15	0.059	30x30		1.77	0.293		
6800	30x50	3.50	0.049	820	22x50	2.03	0.243		
	35x40	3.50	0.049		25x40	1.97	0.243		
	8200	35x45	3.90		0.057	30x30	1.95	0.243	
80(100)	820	22x25	1.20	0.404	180(225)	270	22x25	0.85	0.737
		22x30	1.35	0.332		330	22x30	1.10	0.603
	1000	22x35	1.59	0.276		390	22x30	1.20	0.510
		25x25	1.50	0.276			25x25	1.25	0.510
	1500	22x40	1.78	0.221		470	22x35	1.36	0.423
		25x30	1.70	0.221			25x30	1.40	0.423
		30x25	1.75	0.221		560	22x40	1.56	0.355
	1800	22x45	2.01	0.184			25x30	1.55	0.355
		25x35	1.95	0.184			30x25	1.60	0.355
		30x30	2.03	0.184		680	22x45	1.75	0.293
	2200	25x40	2.17	0.151	25x35		1.67	0.293	
		30x30	2.15	0.151	30x30		1.80	0.293	
		35x25	2.19	0.151	35x25	1.84	0.293		
	2700	25x45	2.45	0.123	820	25x40	1.95	0.243	
		30x35	2.45	0.123		30x30	1.96	0.243	
		35x30	2.52	0.123		35x25	2.05	0.243	
	3300	30x40	2.75	0.100	1000	25x50	2.27	0.199	
		35x35	2.83	0.100		30x35	2.20	0.199	
		3900	30x45	3.13		0.085	35x30	2.25	0.199
	35x35		3.10	0.085	1200	30x40	2.50	0.166	
4700	35x40		3.40	0.071		35x30	2.40	0.166	
5600	35x50	3.80	0.059	1500	35x35	2.78	0.133		
100(125)	560	22x25	1.20		0.592	1800	35x40	3.17	0.111
	680	22x30	1.35	0.488	200(250)	220	22x25	0.85	0.904
	820	22x30	1.50	0.404		270	22x25	0.94	0.737
		25x25	1.50	0.404		330	22x30	1.15	0.603
	1000	22x35	1.70	0.332	25x25		1.15	0.603	
		25x30	1.70	0.332	390	22x35	1.31	0.510	
	1200	22x40	1.97	0.276					
		25x35	1.99	0.276					
		30x25	1.95	0.276					
	1500	22x45	2.15	0.221					
25x40		2.19	0.221						
30x30		2.15	0.221						
35x25		2.21	0.221						
1800	25x45	2.45	0.184						
	30x35	2.45	0.184						
	35x30	2.52	0.184						

Jamicon Series : HT

Teapo Series : LJ

■ STANDARD RATINGS

Rated Voltage (Surge Voltage) (V)	Cap (μF)	Case size Φ DxL(mm)	Ripple current (A/rms105°C) (120Hz)	ESR (Ω,20°C) (120Hz)	Rated Voltage (Surge Voltage) (V)	Cap (μF)	Case size Φ DxL(mm)	Ripple current (A/rms105°C) (120Hz)	ESR (Ω,20°C) (120Hz)
200(250)	390	25x25	1.22	0.510	315(365)	390	30x45	1.71	0.510
	470	22x40	1.52	0.423			35x30	1.60	0.510
		25x30	1.48	0.423		30x50	1.85	0.423	
		30x25	1.50	0.423		35x35	1.75	0.423	
	560	22x45	1.75	0.355		560	35x40	2.00	0.355
		25x35	1.68	0.355	680	35x45	2.20	0.293	
		30x30	1.76	0.355	350(400)	82	22x25	0.60	2.426
	680	25x40	1.96	0.293		100	22x30	0.70	1.989
		30x30	1.94	0.293		120	25x25	0.70	1.989
		35x25	1.98	0.293			22x30	0.74	1.658
	25x45	2.27	0.243	25x25			0.75	1.658	
	820	30x35	2.26	0.243		150	22x35	0.78	1.326
		35x30	2.33	0.243			25x30	0.82	1.326
		30x40	2.65	0.199			30x25	0.85	1.326
	1000	35x30	2.58	0.199		180	22x40	0.96	1.105
30x45		3.05	0.166	25x35			1.05	1.105	
35x35		3.00	0.166	30x30			1.05	1.105	
1500	35x45	3.58	0.133	220		22x50	1.16	0.904	
250(300)	150	22x25	0.75	1.326		25x40	1.10	0.904	
	180	22x30	0.85	1.105		30x30	1.10	0.904	
	220	22x30	1.00	0.904		35x25	1.15	0.904	
		25x25	1.00	0.904	270	25x45	1.22	0.737	
	270	22x35	1.22	0.737	30x35	1.25	0.737		
		25x25	1.15	0.737	35x30	1.30	0.737		
	330	22x35	1.25	0.603	30x40	1.30	0.603		
		25x30	1.30	0.603	35x30	1.35	0.603		
	390	22x40	1.42	0.510	390	30x45	1.50	0.510	
		25x35	1.48	0.510	35x35	1.55	0.510		
		30x25	1.45	0.510	470	35x40	1.72	0.423	
		35x25	1.59	0.510	560	35x45	2.05	0.355	
		470	22x50	1.78	0.423	400(450)	68	22x25	0.55
	25x40		1.75	0.423	82		22x30	0.65	2.426
	30x30		1.72	0.423	100		25x25	0.65	2.426
	35x25		1.78	0.423			22x30	0.75	1.989
	560		25x40	1.80	0.355		25x25	0.75	1.989
		30x35	1.89	0.355	120		22x35	0.84	1.658
		35x25	1.85	0.355			25x30	0.85	1.658
	680	25x50	2.14	0.293	30x25		0.87	1.658	
		30x35	2.05	0.293	150		22x40	0.90	1.326
		35x30	2.12	0.293			25x35	0.90	1.326
	30x45	2.49	0.243	30x30			0.94	1.326	
	820	35x35	2.45	0.243	35x25		0.96	1.326	
		30x50	2.80	0.199	180		22x45	1.05	1.105
35x40		2.86	0.199	25x40			1.06	1.105	
35x45	3.29	0.166	30x30	1.10			1.105		
315(365)	82	22x25	0.55	2.426	35x25		1.12	1.105	
	100	22x30	0.65	1.989	25x45		1.20	0.904	
	120	22x30	0.75	1.658	30x35		1.20	0.904	
		25x25	0.75	1.658	35x30		1.24	0.904	
	150	22x35	0.80	1.326	25x50		1.36	0.737	
		25x30	0.80	1.326	270		30x40	1.38	0.737
	180	22x40	1.01	1.105	35x30		1.35	0.737	
		25x35	1.02	1.105	30x45		1.58	0.603	
		30x25	1.00	1.105	35x35		1.56	0.603	
	220	22x45	1.10	0.904	390		35x40	1.79	0.510
		25x40	1.12	0.904	35x50	1.87	0.510		
		30x30	1.10	0.904	470	35x45	2.07	0.423	
	270	25x45	1.25	0.737	450(500)	56	22x25	0.55	4.737
		30x35	1.25	0.737		68	22x30	0.65	3.901
		25x50	1.53	0.603		82	22x35	0.80	3.235
30x40		1.53	0.603	25x25			0.75	3.235	
35x30		1.50	0.603	100			22x40	0.89	2.653

Jamicon Series : HT

Teapo Series : LJ

■ STANDARD RATINGS

Rated Voltage (SurageVoltage) (V)	Cap (μ F)	Case size Φ DxL(mm)	Ripple current (A/rms105°C) (120Hz)	ESR (Ω ,20°C) (120Hz)	Rated Voltage (SurageVoltage) (V)	Cap (μ F)	Case size Φ DxL(mm)	Ripple current (A/rms105°C) (120Hz)	ESR (Ω ,20°C) (120Hz)	
450(500)	100	25x30	0.85	2.653	500(550)	180	25x50	1.20	1.842	
	120	22x45	0.95	2.210		180	30x40	1.17	1.842	
		25x35	0.92	2.210			35x30	1.10	1.842	
		30x25	0.90	2.210			220	30x45	1.33	1.507
	150	22x50	1.14	1.768		35x35		1.23	1.507	
		25x40	1.11	1.768		270	30x50	1.50	1.228	
		30x30	1.10	1.768			35x40	1.42	1.228	
	180	25x45	1.25	1.474		330	35x45	1.60	1.005	
		30x35	1.24	1.474		390	35x50	1.78	0.850	
		35x25	1.20	1.474		470	35x60	2.03	0.705	
	220	25x50	1.36	1.206	550(600)	47	22x30	0.55	7.055	
		30x40	1.38	1.206		56	22x35	0.64	5.921	
		35x30	1.35	1.206		68	25x30	0.71	4.876	
		270	30x45	1.51		0.982	82	22x40	0.82	4.044
			35x35	1.50		0.982		25x35	0.83	4.044
		330	30x50	1.70		0.804		30x25	0.81	4.044
35x40			1.70	0.804		100	22x45	0.87	3.316	
390		35x45	1.90	0.680			30x30	0.88	3.316	
		470	35x50	2.10		0.564	120	22x50	1.00	2.763
500(550)	47	22x25	0.51	7.055		25x40		0.97	2.763	
	56	22x30	0.58	5.921		30x35		1.02	2.763	
	68	25x25	0.65	4.876		35x25	0.98	2.763		
	82	22x35	0.72	4.044		150	25x45	1.15	2.210	
		25x30	0.74	4.044			30x40	1.21	2.210	
	100	22x45	0.83	3.316			35x30	1.18	2.210	
		30x25	0.82	3.316		180	30x45	1.26	1.842	
	120	22x50	0.93	2.763	35x35		1.24	1.842		
		25x35	0.93	2.763	220	30x50	1.45	1.507		
		30x30	0.91	2.763		35x40	1.45	1.507		
	150	25x45	1.08	2.210	270	35x45	1.68	1.228		
		30x35	1.04	2.210	330	35x50	1.95	1.005		
		35x25	0.99	2.210	390	35x60	2.12	0.850		

Jamicon Series : HB

Teapo Series : GB Long Life&Large Capacitance

- Endurance: 105°C 3000hours
- Recommended Applications : Applying to switching power supply and other industry/ commercial field
- Corresponding product to RoHS



SPECIFICATIONS

Item	Characteristics																																																																															
Category Temperature Range	-40~+105°C																																																																															
Rated Voltage Range	16 ~500VDC																																																																															
Rated Capacitance Range	390 ~ 250000 μF																																																																															
Capacitance Tolerance	± 20 % (120Hz , 20°C)																																																																															
Leakage Current (20°C)	$I = \sqrt[3]{CV}$. (After rated voltage applied for 5 minutes) I : Max. leakage current (μA), C : Nominal capacitance (μF), V : Rated voltage (V)																																																																															
Dissipation Factor(MAX) (tan δ) (120Hz ,20°C)	<table border="1"> <thead> <tr> <th>WV</th> <th>16</th> <th>25</th> <th>35</th> <th>50</th> <th colspan="2">63</th> <th colspan="2">80</th> <th>100</th> <th>160-400</th> <th>450</th> <th>500</th> </tr> <tr> <th>Capacitance</th> <td>—</td> <td>—</td> <td>—</td> <td>—</td> <td>≤27,000</td> <td>>27,000</td> <td>≤15,000</td> <td>>15,000</td> <td>—</td> <td>—</td> <td>—</td> <td>—</td> </tr> </thead> <tbody> <tr> <td rowspan="4">tan δ</td> <td>35 Φ</td> <td>0.80</td> <td>0.60</td> <td>0.50</td> <td>0.40</td> <td>0.35</td> <td>0.40</td> <td>0.25</td> <td>0.30</td> <td>0.25</td> <td>0.15</td> <td>0.20</td> <td>0.25</td> </tr> <tr> <td>40 Φ</td> <td>0.90</td> <td>0.70</td> <td>0.60</td> <td>0.45</td> <td>0.35</td> <td>0.40</td> <td>0.25</td> <td>0.30</td> <td>0.25</td> <td>0.15</td> <td>0.20</td> <td>0.25</td> </tr> <tr> <td>45 Φ</td> <td>1.00</td> <td>0.80</td> <td>0.70</td> <td>0.50</td> <td>0.35</td> <td>0.40</td> <td>0.25</td> <td>0.30</td> <td>0.25</td> <td>0.15</td> <td>0.20</td> <td>0.25</td> </tr> <tr> <td>50 Φ</td> <td>1.20</td> <td>1.00</td> <td>0.75</td> <td>0.55</td> <td>0.35</td> <td>0.40</td> <td>0.25</td> <td>0.30</td> <td>0.25</td> <td>0.15</td> <td>0.20</td> <td>0.25</td> </tr> </tbody> </table>	WV	16	25	35	50	63		80		100	160-400	450	500	Capacitance	—	—	—	—	≤27,000	>27,000	≤15,000	>15,000	—	—	—	—	tan δ	35 Φ	0.80	0.60	0.50	0.40	0.35	0.40	0.25	0.30	0.25	0.15	0.20	0.25	40 Φ	0.90	0.70	0.60	0.45	0.35	0.40	0.25	0.30	0.25	0.15	0.20	0.25	45 Φ	1.00	0.80	0.70	0.50	0.35	0.40	0.25	0.30	0.25	0.15	0.20	0.25	50 Φ	1.20	1.00	0.75	0.55	0.35	0.40	0.25	0.30	0.25	0.15	0.20	0.25
	WV	16	25	35	50	63		80		100	160-400	450	500																																																																			
	Capacitance	—	—	—	—	≤27,000	>27,000	≤15,000	>15,000	—	—	—	—																																																																			
	tan δ	35 Φ	0.80	0.60	0.50	0.40	0.35	0.40	0.25	0.30	0.25	0.15	0.20	0.25																																																																		
40 Φ		0.90	0.70	0.60	0.45	0.35	0.40	0.25	0.30	0.25	0.15	0.20	0.25																																																																			
45 Φ		1.00	0.80	0.70	0.50	0.35	0.40	0.25	0.30	0.25	0.15	0.20	0.25																																																																			
50 Φ		1.20	1.00	0.75	0.55	0.35	0.40	0.25	0.30	0.25	0.15	0.20	0.25																																																																			
Low Temperature Stability Impedance Ratio (MAX)	Measurement frequency : 120Hz																																																																															
	<table border="1"> <thead> <tr> <th>WV</th> <th>16~100</th> <th>160~250</th> <th>350~450</th> <th>500</th> </tr> </thead> <tbody> <tr> <td>Z-25°C / Z+20°C</td> <td>4</td> <td>6</td> <td>8</td> <td>8</td> </tr> <tr> <td>Z-40°C / Z+20°C</td> <td>15</td> <td>—</td> <td>—</td> <td>—</td> </tr> </tbody> </table>	WV	16~100	160~250	350~450	500	Z-25°C / Z+20°C	4	6	8	8	Z-40°C / Z+20°C	15	—	—	—																																																																
	WV	16~100	160~250	350~450	500																																																																											
Z-25°C / Z+20°C	4	6	8	8																																																																												
Z-40°C / Z+20°C	15	—	—	—																																																																												
Endurance	After applying rated voltage with rated Ripple current for 3000hrs at 105°C,when the capacitors are restored to 20°C, the capacitor shall meet the following requirements. <table border="1"> <tbody> <tr> <td>Capacitance change</td> <td>Within ± 20% of initial value</td> </tr> <tr> <td>D.F. (tan δ)</td> <td>Not more than200% of specified value</td> </tr> <tr> <td>Leakage current</td> <td>initial specified value or less</td> </tr> </tbody> </table>	Capacitance change	Within ± 20% of initial value	D.F. (tan δ)	Not more than200% of specified value	Leakage current	initial specified value or less																																																																									
Capacitance change	Within ± 20% of initial value																																																																															
D.F. (tan δ)	Not more than200% of specified value																																																																															
Leakage current	initial specified value or less																																																																															
Shelf Life	The following specifications shall be satisfied when the capacitors are restored to 20°C after exposing them for1,000 hours at 105°C without voltage applied. Before the measurement, the capacitor shall be preconditioned by applying voltage according to item 4.1 of JIS C 5101-4.																																																																															

Dimensions [mm]

Code 11~13 : S1G(35 Φ)

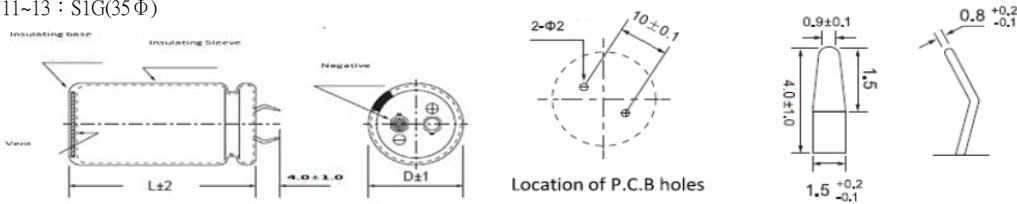

Code 11~13 : L4A(35~45 Φ)

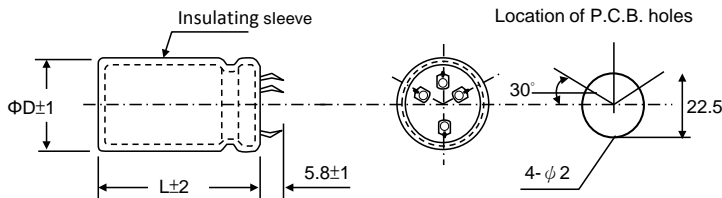

Code 11~13 : L5A(50 Φ)

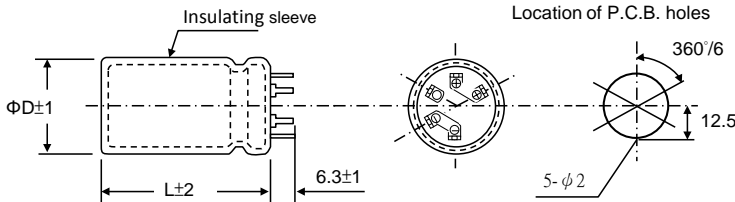

※When the code 11~13 of part number is S1G, the terminal length of standard capacitor is 4.0±1.0mm, and when it is S1A, the terminal length of standard capacitor is 5.8±1.0mm.

Multiplier for Ripple Current

Freq. (Hz)	60	120	400	1K	10K
≤100V	0.80	1.00	1.10	1.20	1.20
>100V	0.80	1.00	1.10	1.30	1.40

Jamicon Series : HB

Teapo Series : GB

■ STANDARD RATINGS

Rated Voltage (SurageVoltage) (V)	Cap (μ F)	Case size Φ DxL(mm)	$\tan \delta$	Ripple current (A/rms105°C) (120Hz)	Rated Voltage (SurageVoltage) (V)	Cap (μ F)	Case size Φ DxL(mm)	$\tan \delta$	Ripple current (A/rms105°C) (120Hz)
16 (20)	68000	35x60	0.80	6.85	50 (63)	18000	35x60	0.40	5.44
		40x51	0.90	7.39			40x61	0.45	6.03
	82000	35x80	0.80	8.16		22000	35x80	0.40	6.83
		40x61	0.90	7.70			40x61	0.45	5.64
	100000	35x80	0.80	8.15		27000	35x80	0.40	6.30
		40x71	0.90	8.67			40x71	0.45	6.68
		45x50	1.00	7.59			45x60	0.50	6.30
	120000	35x100	0.80	8.84		33000	35x100	0.40	7.33
		40x81	0.90	9.11			40x81	0.45	6.4
		45x60	1.00	8.54			45x70	0.50	7.44
		50x50	1.20	9.23			50x60	0.55	8.67
	150000	40x101	0.90	10.07		39000	40x101	0.45	7.26
		45x70	1.00	9.18			45x80	0.50	6.62
		50x60	1.20	10.19			50x70	0.55	9.31
	180000	45x80	1.00	10.06		47000	45x90	0.50	7.66
		50x80	1.20	11.47			50x80	0.55	9.52
220000	45x100	1.00	10.84	56000	45x100	0.50	8.76		
	50x90	1.20	12.01		50x90	0.55	9.94		
250000	50x100	1.20	12.67	68000	50x100	0.55	10.91		
25 (32)	39000	35x60	0.60	6.26	63 (79)	12000	35x60	0.35	4.74
		40x51	0.70	6.09			40x51	0.35	4.78
	47000	35x60	0.60	6.57		15000	35x70	0.35	5.2
		40x51	0.70	6.59			40x51	0.35	4.90
	56000	35x80	0.60	7.78		18000	35x80	0.35	6.05
		40x61	0.70	7.22			40x61	0.35	5.79
	45x50	0.80	6.65	45x50			0.35	5.70	
	50x50	1.00	8.62	50x50			0.35	6.07	
	68000	35x90	0.60	8.62		22000	35x90	0.35	7.06
		40x81	0.70	9.00			40x81	0.35	7.24
		45x60	0.80	7.91			45x60	0.35	6.80
	82000	35x100	0.60	8.94		27000	50x60	0.35	7.23
		40x81	0.70	8.99			40x91	0.35	8.07
		45x70	0.80	8.43			45x70	0.35	7.68
	100000	50x50	1.00	8.71		33000	50x60	0.35	7.64
		40x101	0.70	9.87			40x101	0.40	7.91
		45x80	0.80	9.86			45x80	0.40	7.61
	120000	50x60	1.00	9.95		39000	50x80	0.40	8.08
45x100		0.80	10x74	45x100	0.40		8.66		
50x80		1.00	11.28	50x90	0.40		8.76		
180000	50x100	1.00	12.47	47000	50x100	0.40	9.51		
35 (44)	27000	35x60	0.50	5.71	80 (100)	8200	35x60	0.25	4.64
		40x51	0.60	5.70			40x51	0.25	4.67
	33000	35x70	0.50	6.46		10000	35x70	0.25	5.48
		40x61	0.60	6.80			40x61	0.25	5.57
	39000	35x80	0.50	6.78		12000	45x50	0.25	5.48
		40x71	0.60	7.27			35x80	0.25	6.11
	47000	45x50	0.70	6.20		15000	40x71	0.25	6.24
		35x100	0.50	8.23			45x60	0.25	6.21
		40x81	0.60	8.09			50x50	0.25	6.13
		45x60	0.70	7.03		35x100	0.25	6.91	
		50x50	0.75	8.53		18000	40x81	0.25	6.76
	40x91	0.60	8.88	45x70			0.25	6.77	
	56000	45x70	0.70	8.56		22000	50x60	0.25	6.74
		50x60	0.75	9.31			40x101	0.30	7.11
		40x101	0.60	9.28			45x80	0.30	6.83
	68000	45x80	0.70	9.56		27000	50x80	0.30	7.25
		50x80	0.75	11.14			45x100	0.30	7.92
		45x100	0.70	11.07			50x90	0.30	8.02
82000	50x90	0.75	11.33	100 (125)	4700	35x60	0.25	4.10	
	50x100	0.75	11.92			40x51	0.25	4.13	
50 (63)	15000	35x60	0.40	5.17	5600	35x70	0.25	4.62	
		40x51	0.45	4.91					

Jamicon Series : HB

Teapo Series : GB

■ STANDARD RATINGS

Rated Voltage (SurageVoltage) (V)	Cap (μ F)	Case size Φ DxL(mm)	tan δ	Ripple current (A/rms105°C) (120Hz)	Rated Voltage (SurageVoltage) (V)	Cap (μ F)	Case size Φ DxL(mm)	tan δ	Ripple current (A/rms105°C) (120Hz)
100 (125)	5600	40x61	0.25	4.69	180 (225)	5600	50x90	0.15	6.02
		35x80	0.25	5.40			6800	50x100	0.15
	8200	40x61	0.25	5.17		1800		35x60	0.15
		45x50	0.25	5.09			40x51	0.15	3.06
		35x90	0.25	5.56		2200	35x80	0.15	4.11
		40x81	0.25	6.18			40x61	0.15	3.65
		45x60	0.25	5.80			45x50	0.15	3.60
		10000	50x60	0.25		6.65	2700	35x80	0.15
	35x100		0.25	6.45		40x81		0.15	4.58
	40x81		0.25	6.83		45x60		0.15	4.3
	12000		45x70	0.25		6.84	3300	35x90	0.15
		50x60	0.25	7.08		40x71		0.15	4.78
		40x101	0.25	7.63		45x70		0.15	5.08
		45x80	0.25	7.33		50x50		0.15	5.23
	15000	50x70	0.25	7.66		3900	35x100	0.15	6.06
		45x100	0.25	8.30			40x81	0.15	5.51
		50x60	0.25	8.34			45x80	0.15	5.85
	18000	50x100	0.25	9.24			50x60	0.15	5.92
160 (200)	2200	35x60	0.15	3.36	4700	40x101	0.15	6.42	
		40x51	0.15	3.39		45x90	0.15	6.50	
	2700	35x70	0.15	3.83		50x80	0.15	7.07	
		40x61	0.15	3.89		5600	45x100	0.15	7.44
		45x50	0.15	3.83			50x90	0.15	7.83
	3300	35x80	0.15	4.32		6800	50x100	0.15	9.04
		40x71	0.15	4.41	250 (300)		1500	35x70	0.15
		45x60	0.15	4.39		1800	35x80	0.15	3.72
	50x50	0.15	4.33	40x61			0.15	3.56	
	35x90	0.15	4.95	45x50			0.15	3.50	
	3900	40x81	0.15	5.08		2200	35x80	0.15	3.97
		45x70	0.15	5.09			40x81	0.15	4.29
		50x60	0.15	5.07			45x60	0.15	4.03
	4700	35x100	0.15	5.23		2700	50x50	0.15	4.42
		40x91	0.15	5.39			35x100	0.15	4.86
		45x80	0.15	5.43			40x81	0.15	4.76
		50x70	0.15	5.44			45x70	0.15	4.77
	5600	40x101	0.15	5.61		3300	50x60	0.15	5.10
		45x90	0.15	5.68	40x101		0.15	5.59	
		50x80	0.15	5.72	45x80		0.15	5.38	
	6800	45x100	0.15	5.90	3900	50x70	0.15	5.81	
		50x90	0.15	5.97		45x90	0.15	6.16	
	8200	50x100	0.15	6.11	50x80	0.15	6.21		
	180 (225)	1800	35x60	0.15	3.27	4700	45x100	0.15	6.82
40x51			0.15	3.30	50x100		0.15	7.22	
2200		35x70	0.15	3.87	350 (400)	820	35x60	0.15	2.76
		40x61	0.15	3.93		1000	40x51	0.15	2.78
		45x50	0.15	3.88			35x70	0.15	2.05
35x80		0.15	4.39	40x61			0.15	2.08	
2700		40x71	0.15	4.49		45x50	0.15	2.05	
		45x60	0.15	4.46		50x50	0.15	3.58	
		50x50	0.15	4.41		1200	35x80	0.15	3.26
35x90		0.15	4.74	40x71			0.15	3.32	
40x81		0.15	4.87	45x60			0.15	3.32	
3300		45x70	0.15	4.88		1500	50x50	0.15	3.70
		50x60	0.15	4.86			35x100	0.15	4.57
		35x100	0.15	5.20			40x81	0.15	3.81
3900		40x91	0.15	5.35	1800	45x70	0.15	3.82	
		45x80	0.15	5.40		50x60	0.15	4.19	
		50x70	0.15	5.41		40x101	0.15	5.24	
4700		40x101	0.15	5.65	2200	45x80	0.15	5.04	
		45x90	0.15	5.72		50x80	0.15	5.84	
		50x80	0.15	5.76		45x100	0.15	6.15	
5600		45x100	0.15	5.95	50x100	0.15	6.72		

Jamicon Series : HB

Teapo Series : GB

■ STANDARD RATINGS

Rated Voltage (SurageVoltage) (V)	Cap (μ F)	Case size Φ DxL(mm)	tan δ	Ripple current (A/rms105°C) (120Hz)	Rated Voltage (SurageVoltage) (V)	Cap (μ F)	Case size Φ DxL(mm)	tan δ	Ripple current (A/rms105°C) (120Hz)	
400 (450)	680	35x60	0.15	2.37	450 (500)	1000	45x70	0.20	3.65	
		40x51	0.15	2.39			50x70	0.20	4.22	
	820	35x70	0.15	2.79			1200	40x101	0.20	4.41
		40x61	0.15	2.83				45x80	0.20	4.24
		45x50	0.15	2.79		50x80	0.20	4.90		
		50x50	0.15	3.42		1500	45x90	0.20	4.65	
	1000	35x80	0.15	3.27			50x90	0.20	6.12	
		40x61	0.15	3.13		1800	45x100	0.20	5.24	
		45x60	0.15	3.32			50x100	0.20	6.04	
		50x60	0.15	4.07		500(550)	390	35x60	0.25	1.60
	35x100	0.15	3.96	40x51				0.25	1.61	
	1200	40x81	0.15	3.88			470	35x70	0.25	1.88
		45x70	0.15	3.88				40x61	0.25	1.91
		50x60	0.15	4.45				45x50	0.25	1.88
	1500	40x101	0.15	4.79			560	35x80	0.25	2.18
		45x80	0.15	4.60				40x71	0.25	2.23
		50x80	0.15	5.62				45x60	0.25	2.22
		1800	45x100	0.15				5.57	50x50	0.25
50x100	0.15		6.8	680	35x100		0.25	2.66		
450 (500)	470	35x60	0.20		2.03		40x81	0.25	2.60	
		35x70	0.20		2.37		45x70	0.25	2.61	
	560	40x51	0.20		2.23	50x60	0.25	2.75		
		680	35x80		0.20	2.78	820	40x101	0.25	2.88
			40x61		0.20	2.66		45x80	0.25	3.04
	45x50		0.20	2.62	50x70	0.25		3.22		
	50x50		0.20	3.03	1000	45x90	0.25	3.53		
	820	35x90	0.20	3.22		50x80	0.25	3.77		
		40x71	0.20	3.11	1200	45x100	0.25	4.06		
		45x60	0.20	3.10		50x90	0.25	4.35		
		50x60	0.20	3.59	1500	50x100	0.25	4.74		
	1000	40x91	0.20	3.84						

Jamicon Series : HL

Teapo Series : LQ Long Life Series

- Endurance: 105°C 5000 hours
- Recommended Applications : Smoothing circuit, TV/Monitor,Adapter, SMPS
- Corresponding product to RoHS

550V
LINE
UP



SPECIFICATIONS

Item	Characteristics		
Category Temperature Range	-40 ~ +105°C	-25 ~ +105°C	
Rated Voltage Range	160 ~ 500VDC	DC > 500V	
Rated Capacitance Range	56 ~ 2200 μF	100 ~ 470 μF	
Capacitance Tolerance	± 20 % at 120Hz , 20		
Leakage Current (20°C)	DC≤500V $I = \sqrt[3]{CV}$ DC> 500V $I=0.02CV$ or 3mA whichever is greater (After rated voltage applied for 5 minutes) I : Max. leakage current (μA), C : Nominal capacitance (μF), V : Rated voltage (V)		
Dissipation Factor(MAX) (tan δ) (120Hz, 20°C)	WV	160~400 420~450 500~550	
	Capacitance	- - -	
	tan δ	0.15 0.20 0.25	
Low Temperature Stability Impedance Ratio (MAX)	Measurement frequency : 120Hz		
	Rated voltage(V)	160~400 420~450 500~550	
	Z-25°C / Z+20°C	4 8 8	
Endurance	After applying rated voltage with rated Ripple current for 5000hrs at 105°C, when the capacitors are restored to 20°C, the capacitor shall meet the following requirement.		
	Capacitance change	Within ± 20% of initial value	
	D.F. (tan δ)	Not more than 200% of specified value	
Shelf Life	The following specifications shall be satisfied when the capacitors are restored to 20°C after exposing them for 1,000 hours at 105°C without voltage applied. Before the measurement, the capacitor shall be preconditioned by applying voltage according to item 4.1 of JIS C 5101-4.		

Dimensions [mm]

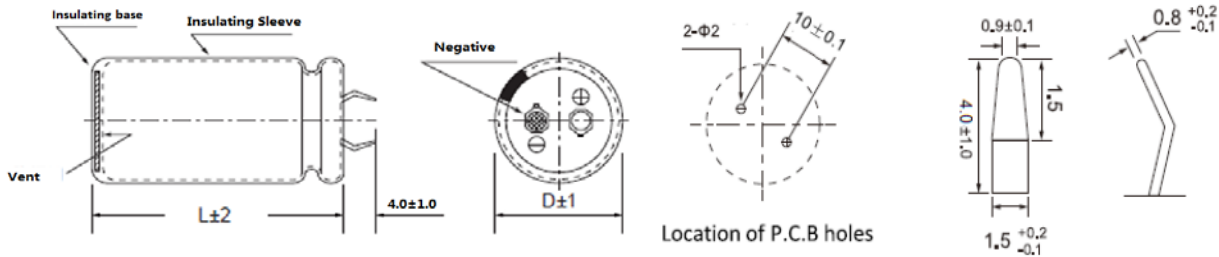

※When the code 11~13 of part number is S1G, the terminal length of standard capacitor is 4.0±1.0mm, and when it is S1A, the terminal length of standard capacitor is 5.8±1.0mm.

Multiplier for Ripple Current

Freq. (Hz)	50	60	120	1K	10k~100k
6.3~100V	0.88	0.90	1.00	1.20	1.30
160~250V	0.85	0.88	1.00	1.30	1.50
315~450	0.88	0.90	1.00	1.35	1.45
500~550	0.70	0.72	1.00	1.30	1.40

Jamicon Series : HL

Teapo Series : LQ

■ STANDARD RATINGS

Rated Voltage (Surge Voltage) (V)	Cap (μF)	Case size Φ D x L (mm)	Ripple current (A/rms105°C) (120Hz)	ESR (Ω,20°C) (120Hz)	Rated Voltage (Surge Voltage) (V)	Cap (μF)	Case size Φ D x L (mm)	Ripple current (A/rms105°C) (120Hz)	ESR (Ω,20°C) (120Hz)
160(200)	270	22x25	0.85	0.737	200(250)	680	35x25	1.98	0.293
	330	22x30	1.00	0.603		820	25x45	2.27	0.243
	390	22x30	1.15	0.51			30x35	2.26	0.243
		25x25	1.15	0.51			35x30	2.33	0.243
	470	22x35	1.30	0.423		1000	30x45	2.78	0.199
		25x30	1.30	0.423			35x35	2.74	0.199
	560	22x40	1.57	0.355		1200	30x50	3.19	0.166
		25x30	1.50	0.355			35x40	3.17	0.166
		30x25	1.54	0.355		1500	35x45	3.72	0.133
	680	22x45	1.75	0.293		250 (300)	150	22x25	0.75
		25x35	1.70	0.293	180		22x25	0.76	1.110
		30x30	1.77	0.293	220		22x30	1.00	0.905
	820	22x50	2.03	0.243			25x25	1.00	0.905
		25x40	1.97	0.243	270		22x30	1.05	0.737
		30x30	1.95	0.243			25x25	1.15	0.737
	1000	35x25	1.99	0.243	330		22x35	1.22	0.603
		25x45	2.15	0.199			25x30	1.30	0.603
		1200	30x35	2.15	0.199		390	22x40	1.37
	35x30		2.21	0.199	25x35			1.48	0.510
	30x40		2.45	0.166	30x30	1.45		0.510	
1500	35x35	2.52	0.166	35x25	1.59	0.510			
	30x50	2.75	0.133	470	22x50	1.78	0.423		
	35x40	2.75	0.133		25x40	1.75	0.423		
1800	35x45	3.00	0.111		30x30	1.72	0.423		
	35x50	3.50	0.09		35x25	1.66	0.423		
180(225)	270	22x25	0.85	0.737	560	25x40	1.80	0.355	
	330	22x30	1.10	0.603		30x35	1.89	0.3550	
	390	22x35	1.32	0.51		35x30	1.94	0.3550	
		25x25	1.25	0.51		680	25x50	2.10	0.2930
	470	22x40	1.47	0.423			30x40	2.15	0.293
		25x30	1.40	0.423		35x30	2.10	0.293	
	560	22x45	1.70	0.355		820	30x45	2.49	0.243
		25x35	1.63	0.355			35x35	2.45	0.243
		30x25	1.60	0.355		1000	30x50	2.80	0.199
	680	22x50	1.87	0.293			35x40	2.86	0.199
		25x40	1.82	0.293	1200	35x50	3.44	0.166	
		30x30	1.80	0.293	315(365)	82	22x25	0.55	2.426
	35x25	1.84	0.293	100		22x30	0.65	1.989	
	820	25x45	2.05	0.243		120	22x30	0.75	1.658
		30x35	2.05	0.243			25x25	0.75	1.658
	1000	35x30	2.11	0.243		150	22x35	0.80	1.326
		25x50	2.27	0.199			25x30	0.80	1.326
		1200	30x40	2.29		0.199	180	22x40	1.01
	35x30		2.25	0.199		25x35		1.02	1.105
	30x45		2.57	0.166		30x25		1.00	1.105
1500	35x35	2.55	0.166	220		22x45	1.10	0.905	
	35x40	2.85	0.133		25x40	1.12	0.905		
1800	35x50	3.10	0.111	270	30x30	1.10	0.905		
200(250)	220	22x25	0.85		0.905	25x45	1.25	0.737	
	270	22x30	1.02	0.737	330	30x35	1.25	0.737	
	330	22x30	1.15	0.603		25x50	1.53	0.603	
		25x25	1.15	0.603	30x40	1.53	0.603		
	390	22x35	1.31	0.510	390	35x30	1.50	0.603	
		25x30	1.32	0.510		30x45	1.71	0.510	
	470	22x40	1.52	0.423	470	35x30	1.60	0.510	
		25x30	1.45	0.423		30x50	1.85	0.423	
		30x25	1.50	0.423	560	35x35	1.75	0.423	
	560	22x45	1.75	0.355		35x40	2.00	0.355	
25x35		1.68	0.355	680	35x45	2.20	0.293		
30x30		1.76	0.355	350(400)	82	22x25	0.60	2.426	
680	25x40	1.96	0.293		100	22x30	0.70	1.989	
	30x30	1.94	0.293		25x25	0.70	1.989		

Jamicon Series : HL

Teapo Series : LQ

■ STANDARD RATINGS

Rated Voltage (SurageVoltage) (V)	Cap (μ F)	Case size Φ DxL(mm)	Ripple current (A/rms105°C) (120Hz)	ESR (Ω ,20°C) (120Hz)	Rated Voltage (SurageVoltage) (V)	Cap (μ F)	Case size Φ DxL(mm)	Ripple current (A/rms105°C) (120Hz)	ESR (Ω ,20°C) (120Hz)		
350(400)	120	25x35	0.80	1.658	450(500)	82	22x30	0.70	3.235		
		25x30	0.80	1.658			25x25	0.75	3.235		
	150	22x40	0.86	1.326		100	22x35	0.80	2.653		
		25x35	0.87	1.326			25x30	0.85	2.653		
		30x25	0.85	1.326			120	22x40	0.88	2.210	
	180	22x45	1.05	1.105		25x35		0.92	2.210		
		25x40	1.07	1.105		30x25		0.90	2.210		
		30x30	1.05	1.105		150	22x50	1.14	1.768		
	220	22x50	1.16	0.905			25x40	1.11	1.768		
		25x45	1.20	0.905			30x30	1.10	1.768		
		30x35	1.18	0.905		180	25x45	1.25	1.474		
		30x25	1.15	0.905			30x35	1.25	1.474		
	270	25x50	1.31	0.737			35x25	1.20	1.474		
		30x40	1.33	0.737		220	25x50	1.36	1.206		
		35x30	1.30	0.737			30x40	1.38	1.206		
	330	30x45	1.46	0.603			35x30	1.35	1.206		
		35x35	1.45	0.603		270	30x45	1.51	0.982		
	390	30x50	1.65	0.510			35x35	1.50	0.982		
35x40		1.65	0.510	330	30x50		1.70	0.804			
470	35x45	1.85	0.423		35x40	1.70	0.804				
	35x50	2.10	0.355		390	35x45	1.90	0.680			
400(450)	68	22x25	0.55	2.926		470	35x50	2.10	0.564		
		22x30	0.65	2.426		500(550)	100	30x25	0.82	3.316	
	82	25x25	0.65	2.426	120		30x30	0.91	2.763		
		22x30	0.70	1.989			35x25	0.88	2.763		
	100	25x25	0.70	1.989	150		30x35	1.04	2.210		
		22x35	0.80	1.658			180	30x40	1.17	1.842	
		25x30	0.85	1.658				35x30	1.10	1.842	
	120	30x25	0.87	1.658	220			30x45	1.33	1.507	
		22x40	0.85	1.326			35x35	1.23	1.507		
		25x35	0.90	1.326			270	30x50	1.50	1.228	
	150	30x30	0.94	1.326	35x40			1.42	1.228		
		35x25	0.96	1.326	330			35x45	1.60	1.005	
		22x45	1.05	1.105			390	35x50	1.78	0.850	
		25x40	1.11	1.105			470	35x60	2.03	0.705	
	180	30x30	1.10	1.105	550(600)		100	22x40	0.83	3.316	
		35x25	1.12	1.105				30x30	0.84	3.316	
		220	25x40	1.15			0.905	120	22x45	0.95	2.763
			30x35	1.20			0.905		30x35	1.00	2.763
35x30	1.24		0.905	150			22x50		1.12	2.210	
270	25x45	1.29	0.737			30x40	1.15	2.210			
	30x40	1.38	0.737			35x30	1.12	2.210			
	35x30	1.35	0.737	180		30x45	1.23	1.842			
330	30x40	1.51	0.603			35x35	1.21	1.842			
	35x35	1.56	0.603			220	30x50	1.42	1.507		
390	30x45	1.72	0.510	35x40			1.41	1.507			
	35x40	1.75	0.510	270			35x45	1.56	1.228		
470	35x40	1.97	0.423			330	35x50	1.81	1.005		
	35x50	2.10	0.355			390	35x60	2.12	0.850		
450(500)	56	22x25	0.55	4.737							
	68	22x30	0.65	3.901							

Jamicon Series : HF

Teapo Series : LK Long Life Series



- Endurance: 105°C 7000hours
- Recommended Applications: Smoothing circuit, TV/Monitor,Adapter, SMPS
- Corresponding product to RoHS

■ SPECIFICATIONS

Item	Characteristics	
Category Temperature Range	-40 ~ +105°C	
Rated Voltage Range	160 ~ 450VDC	
Rated Capacitance Range	39 ~ 2200 µF	
Capacitance Tolerance	± 20 % (120Hz , 20°C)	
Leakage Current (20°C)	$I = \sqrt[3]{CV}$. (After rated voltage applied for 5 minutes) I : Max. leakage current (µA), C : Nominal capacitance (µF), V : Rated voltage (V)	
Dissipation Factor(MAX) (tan δ) (120Hz ,20°C)	WV	160 180 200 250 315 350 400 450
	tan δ	0.15 0.15 0.15 0.15 0.20 0.20 0.20 0.20
Low Temperature Stability Impedance Ratio (MAX)	Measurement frequency : 120Hz	
	Rated voltage(V)	160~400 450
	Z-25°C / Z+20°C	4 8
	Z-40°C / Z+20°C	— —
Endurance	After applying rated voltage with rated Ripple current for 7000hrs at 105°C,when the capacitors are restored to 20°C, the capacitor shall meet the following requirement.	
	Capacitance change	Within ± 20% of initial value
	D.F. (tan δ)	Not more than 200% of specified value
	Leakage current	Not more than the specified value
Shelf Life	The following specifications shall be satisfied when the capacitors are restored to 20°C after exposing them for1,000 hours at 105°C without voltage applied. Before the measurement, the capacitor shall be preconditioned by applying voltage according to item 4.1 of JIS C 5101-4.	

■ Dimensions [mm]

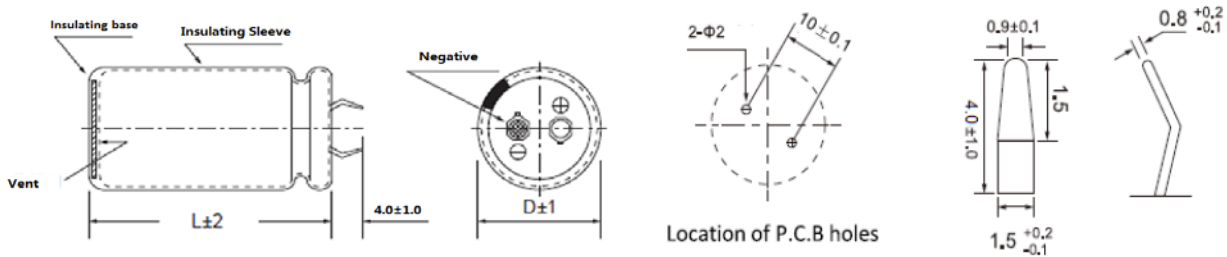

※When the code 11~13 of part number is S1G, the terminal length of standard capacitor is 4.0±1.0mm, and when it is S1A, the terminal length of standard capacitor is 5.8±1.0mm.

■ Multiplier for Ripple Current

Freq. (Hz)	60(50)	120	500	1K	≥10K
160~250WV	0.80	1.00	1.20	1.30	1.40
315~450WV	0.80	1.00	1.20	1.30	1.40

Jamicon Series : HF

Teapo Series : LK

■ STANDARD RATINGS

Rated Voltage (Surge Voltage) (V)	Cap (μF)	Case size Φ D x L (mm)	tan δ	Ripple current (A/rms 105°C) (120Hz)	Rated Voltage (Surge Voltage) (V)	Cap (μF)	Case size Φ D x L (mm)	tan δ	Ripple current (A/rms 105°C) (120Hz)	
160(200)	270	22x25	0.15	1.10	200(250)	470	25x35	0.15	1.46	
	330	22x25	0.15	1.20		30x25	0.15	1.49		
	390	22x30	0.15	1.30		560	22x45	0.15	1.65	
		25x25	0.15	1.30			25x35	0.15	1.59	
	470	22x35	0.15	1.40		680	30x30	0.15	1.66	
		25x30	0.15	1.40			22x50	0.15	1.82	
	560	22x40	0.15	1.60		820	25x40	0.15	1.86	
		25x30	0.15	1.56			30x30	0.15	1.83	
		30x25	0.15	1.54			25x45	0.15	2.04	
	680	22x45	0.15	1.90		1000	30x35	0.15	2.03	
		25x35	0.15	1.83			35x30	0.15	2.00	
		30x30	0.15	1.82			30x40	0.15	2.26	
	820	22x25	0.15	2.00		1200	35x35	0.15	2.34	
		25x40	0.15	2.02			30x45	0.15	2.46	
		30x30	0.15	2.00			35x40	0.15	2.70	
	1000	25x45	0.15	2.35		1500	35x50	0.15	3.15	
		30x35	0.15	2.35			180	22x30	0.15	0.90
		35x30	0.15	2.30				25x25	0.15	0.90
	1200	25x50	0.15	2.56		220	22x30	0.15	1.00	
		30x40	0.15	2.57			25x25	0.15	1.00	
35x35		0.15	2.53	270	22x35		0.15	1.10		
1500		30x45	0.15		2.90		25x30	0.15	1.10	
		35x35	0.15	2.86	30x25		0.15	1.10		
1800		30x50	0.15	3.32	330		22x40	0.15	1.27	
	35x40	0.15	3.30	25x30		0.15	1.21			
2200	35x45	0.15	3.64	30x25	0.15	1.20				
180(225)	220	22x25	0.15	1.00	250(300)	390	22x45	0.15	1.39	
	270	22x25	0.15	1.10			25x35	0.15	1.34	
	330	22x30	0.15	1.20			470	30x30	0.15	1.30
		25x25	0.15	1.20		22x50		0.15	1.60	
	390	22x30	0.15	1.30		560	25x40	0.15	1.56	
		25x25	0.15	1.30			30x35	0.15	1.56	
	470	22x35	0.15	1.40			35x30	0.15	1.61	
		25x30	0.15	1.40		680	25x45	0.15	1.70	
		30x25	0.15	1.40			30x35	0.15	1.62	
	560	22x40	0.15	1.50		820	35x30	0.15	1.67	
		25x35	0.15	1.50			25x50	0.15	1.97	
		30x25	0.15	1.50			30x40	0.15	1.98	
	680	22x45	0.15	1.70		1000	35x35	0.15	1.93	
		25x35	0.15	1.70			30x45	0.15	2.17	
		30x30	0.15	1.70			35x35	0.15	2.14	
	820	25x40	0.15	2.00		1200	30x50	0.15	2.61	
		30x35	0.15	2.00			35x40	0.15	2.50	
		35x30	0.15	2.00			35x45	0.15	2.99	
	1000	25x50	0.15	2.20		315(365)	82	22x25	0.20	0.64
		30x35	0.15	2.20			100	22x30	0.20	0.69
35x30		0.15	2.20	120	22x30		0.20	0.75		
1200	30x40	0.15	2.40		25x25		0.20	0.75		
	35x35	0.15	2.40	150	22x35		0.20	0.82		
1500	30x50	0.15	2.70		25x30		0.20	0.82		
	35x40	0.15	2.70		30x25		0.20	0.82		
1800	35x45	0.15	2.90	180	22x40		0.20	0.90		
	2200	35x50	0.150		2.90		25x30	0.20	0.90	
200(250)	220	22x25	0.15		1.00		30x25	0.20	0.90	
	270	22x30	0.15	1.10	220		22x45	0.20	1.05	
		25x25	0.15	1.10			25x35	0.20	1.05	
	330	22x30	0.15	1.20	270	30x30	0.20	1.05		
		25x25	0.15	1.20		25x40	0.20	1.20		
	390	22x35	0.15	1.30	330	30x35	0.20	1.20		
		25x30	0.15	1.31		35x30	0.20	1.20		
		30x25	0.15	1.30		25x50	0.20	1.35		
	470	22x40	0.15	1.51	30x40	0.20	1.35			

Jamicon Series : HF

Teapo Series : LK

■ STANDARD RATINGS

Rated Voltage (SurageVoltage) (V)	Cap (μ F)	Case size Φ D \times L(mm)	tan δ	Ripple current (A/rms105°C) (120Hz)	Rated Voltage (SurageVoltage) (V)	Cap (μ F)	Case size Φ D \times L(mm)	tan δ	Ripple current (A/rms105°C) (120Hz)	
315(365)	330	35x30	0.20	1.35	400(450)	120	30x25	0.20	0.80	
	390	30x40	0.20	1.50		150	22x45	0.20	0.94	
		35x35	0.20	1.50			25x35	0.20	0.91	
		470	30x45	0.20			1.60	30x30	0.20	0.95
	35x40		0.20	1.60		180	22x50	0.20	0.98	
	560	35x45	0.20	1.70			25x40	0.20	0.96	
680		35x50	0.20	1.90			30x30	0.20	1.09	
	350(400)	82	22x25	0.20			0.64	35x25	0.20	0.97
100		22x30	0.20	0.69			220	25x45	0.20	1.27
		25x25	0.20	0.69				30x35	0.20	1.17
		120	22x35	0.20		0.75		35x30	0.20	1.31
25x30			0.20	0.75		270	30x40	0.20	1.37	
150		22x40	0.20	0.85			35x35	0.20	1.35	
		25x30	0.20	0.89		330	30x45	0.20	1.60	
			30x25	0.20			0.88	35x40	0.20	1.58
180		22x45	0.20	1.02		390	35x45	0.20	1.80	
		25x35	0.20	0.98			470	35x50	0.20	2.07
		30x30	0.20	1.03		450(500)		39	22x25	0.20
			220	22x50	0.20		1.09	47	22x30	0.20
25x40		0.20		1.06	56		22x35	0.20	0.54	
30x30		0.20		1.10			25x25	0.20	0.52	
		270	25x45	0.20	1.24		68	22x40	0.20	0.58
			30x35	0.20	1.30			25x30	0.20	0.58
35x30			0.20	1.27	82		22x45	0.20	0.72	
330		30x40	0.20	1.44			25x35	0.20	0.69	
		35x35	0.20	1.44			30x25	0.20	0.68	
390		30x45	0.20	1.57	100		22x50	0.20	0.78	
		35x35	0.20	1.63			25x40	0.20	0.74	
			470	30x50			0.20	1.90	30x30	0.20
35x40		0.20		1.89	120		25x45	0.20	0.86	
		560	35x50	0.20			2.15	30x30	0.20	0.85
400(450)		56	22x25	0.20	0.51		150	25x50	0.20	1.02
		68	22x30	0.20	0.57			30x40	0.20	1.02
			25x25	0.20	0.57			35x30	0.20	1.00
		82	22x30	0.20	0.66		180	30x45	0.20	1.18
	25x25		0.20	0.64	35x35	0.20		1.29		
	100	22x35	0.20	0.69	220	30x50	0.20	1.24		
		25x30	0.20	0.69		35x40	0.20	1.24		
	120	22x40	0.20	0.80	270	35x45	0.20	1.40		
		25x30	0.20	0.80		330	35x50	0.20	1.60	

Jamicon Series : HX

Teapo Series : LP

Long Life Series



- Endurance: 105°C 10000hours
- Recommended Applications: Smoothing circuit, TV/Monitor,Adapter, SMPS
- Corresponding product to RoHS

■ SPECIFICATIONS

Item	Characteristics				
Category Temperature Range	-40 ~ +105°C				
Rated Voltage Range	200 ~ 450VDC				
Rated Capacitance Range	39 ~ 1500 μF				
Capacitance Tolerance	± 20 % (120Hz , 20°C)				
Leakage Current (20°C)	$I = \sqrt[3]{CV}$. (After rated voltage applied for 5 minutes) I : Max. leakage current (μA), C : Nominal capacitance (μF), V : Rated voltage (V)				
Dissipation Factor(MAX) (tan δ) (120Hz ,20°C)	WV	200	250	400	450
	tan δ	0.15	0.15	0.20	0.20
Low Temperature Stability Impedance Ratio (MAX)	Measurement frequency : 120Hz				
	Rated voltage(V)	200~400	450		
	Z-25°C / Z+20°C	4	8		
Endurance	After applying rated voltage with rated Ripple current for 10000hrs at 105°C,when the capacitors are restored to 20°C , the capacitor shall meet the following requirement.				
	Capacitance change	Within ± 20% of initial value			
	D.F. (tan δ)	Not more than 250% of specified value			
Shelf Life	The following specifications shall be satisfied when the capacitors are restored to 20°C after exposing them for1,000 hours at 105°C without voltage applied. Before the measurement, the capacitor shall be preconditioned by applying voltage according to item 4.1 of JIS C 5101-4.				
	Leakage current	Not more than the specified value			

■ Dimensions [mm]

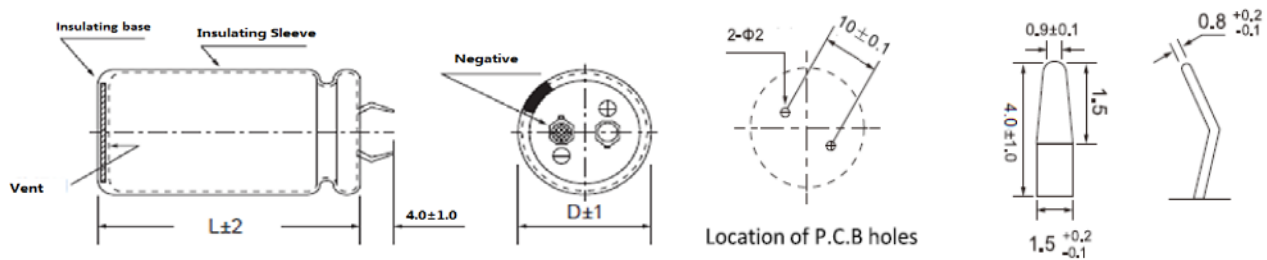

※When the code 11~13 of part number is S1G, the terminal length of standard capacitor is 4.0±1.0mm, and when it is S1A, the terminal length of standard capacitor is 5.8±1.0mm.

■ Multiplier for Ripple Current

Freq. (Hz)	60(50)	120	500	1K	≥ 10K
200~250WV	0.80	1.00	1.20	1.30	1.45
315~450WV	0.80	1.00	1.20	1.25	1.40

Jamicon Series : HX

Teapo Series : LP

■ STANDARD RATINGS

Rated Voltage (SurageVoltage) (V)	Cap (μ F)	Case size Φ DxL(mm)	$\tan \delta$	Ripple current (A/rms105°C) (120Hz)	Rated Voltage (SurageVoltage) (V)	Cap (μ F)	Case size Φ DxL(mm)	$\tan \delta$	Ripple current (A/rms105°C) (120Hz)
200(250)	220	22x25	0.15	1.00	400(450)	56	22x25	0.20	0.51
	270	22x30	0.15	1.10		68	22x30	0.20	0.56
		25x25	0.15	1.10			25x25	0.20	0.56
		330	22x30	0.15			1.20	82	22x35
	25x25		0.15	1.20		25x25	0.20		0.64
	390	22x35	0.15	1.30		100	22x35	0.20	0.69
		25x30	0.15	1.30			25x30	0.20	0.69
		30x25	0.15	1.30			120	22x40	0.20
	470	22x40	0.15	1.40		25x35		0.20	0.75
		25x35	0.15	1.40		30x25		0.20	0.75
		30x30	0.15	1.40		150	22x50	0.20	0.82
	560	22x45	0.15	1.50			25x40	0.20	0.82
		25x35	0.15	1.50			30x30	0.20	0.82
		30x30	0.15	1.50		180	25x45	0.20	0.90
	680	25x40	0.15	1.70			30x35	0.20	0.90
		30x35	0.15	1.70			35x25	0.20	0.90
820		25x50	0.15	2.00	220	25x50	0.20	1.00	
	30x40	0.15	2.00	30x40		0.20	1.00		
	35x30	0.15	2.00	35x30		0.20	1.00		
1000	30x45	0.15	2.22	270	30x45	0.20	1.15		
	35x35	0.15	2.20		35x35	0.20	1.11		
	1200	30x50	0.15		2.53	330	30x50	0.20	1.32
35x40		0.15	2.44	35x40	0.20		1.28		
1500	35x50	0.15	2.50	390	35x45	0.20	1.45		
		470	35x50	0.20	1.66				
250(300)	180	22x30	0.15	0.90	450(500)	39	22x25	0.20	0.37
		25x25	0.15	0.90		47	22x30	0.20	0.40
	220	22x35	0.15	1.00		56	22x35	0.20	0.47
		25x30	0.15	1.00			25x25	0.20	0.47
		22x40	0.15	1.10			68	22x40	0.20
	25x30	0.15	1.10	25x30		0.20		0.53	
	30x25	0.15	1.10	82		22x45		0.20	0.56
	330	22x45	0.15			1.20	25x35	0.20	0.56
		25x35	0.15			1.20	30x25	0.20	0.56
		30x30	0.15	1.20		100	22x50	0.20	0.67
	390	22x50	0.15	1.32			25x40	0.20	0.64
		25x40	0.15	1.23			30x30	0.20	0.64
		30x30	0.15	1.30		120	25x45	0.20	0.72
	470	25x45	0.15	1.42			30x30	0.20	0.72
		30x35	0.15	1.40			25x50	0.20	0.83
		35x30	0.15	1.40		150	30x40	0.20	0.81
	560	25x50	0.15	1.50			35x30	0.20	0.79
		30x40	0.15	1.58			180	30x45	0.20
		35x35	0.15	1.60		35x35		0.20	0.91
	680	30x45	0.15	1.83		220		30x50	0.20
		35x40	0.15	1.85			35x40	0.20	1.05
		820	30x50	0.15			2.09	270	35x45
	35x45		0.15	2.11		330	35x50	0.20	1.38
	1000	35x50	0.15	2.43					

Jamicon Series : HM

Teapo Series : LS

Downsized · Low profile Series



- Endurance: 105°C 2000 hours
- Recommended Applications : Applying to switching power supply and other industry/ commercial field
- Corresponding product to RoHS

SPECIFICATIONS

Item	Characteristics					
Category Temperature Range	-25 ~ +105°C					
Rated Voltage Range	160 ~ 450VDC					
Rated Capacitance Range	100 ~ 3300 μF					
Capacitance Tolerance	± 20 % (120Hz , 20°C)					
Leakage Current (20°C)	$I = \sqrt[3]{CV}$. (After rated voltage applied for 5 minutes) I : Max. leakage current (μA), C : Nominal capacitance (μF), V : Rated voltage (V)					
Dissipation Factor(MAX) (tan δ) (120Hz ,20°C)	WV	160	200	220~400	420	450
	tan δ	0.15	0.15	0.15	0.20	0.20
Low Temperature Stability Impedance Ratio (MAX)	Measurement frequency : 120Hz					
	WV	160	200	220~400	420	450
	Z-25°C / Z+20°C	4	4	4	8	8
Endurance	After applying rated voltage with rated Ripple current for 2000hrs at 105°C, the capacitor shall meet the following requirements.					
	Capacitance change	Within ± 20% of initial value				
	D.F. (tan δ)	Not more than 200% of specified value				
	Leakage current	initial specified value or less				
Shelf Life	The following specifications shall be satisfied when the capacitors are restored to 20°C after exposing them for 1,000 hours at 105°C without voltage applied. Before the measurement, the capacitor shall be preconditioned by applying voltage according to item 4.1 of JIS C 5101-4.					

Dimensions [mm]

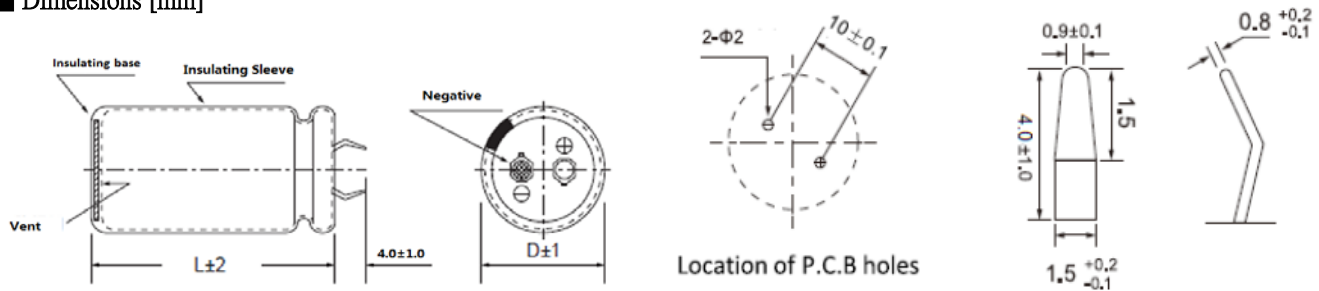

※When the code 11~13 of part number is S1G, the terminal length of standard capacitor is 4.0±1.0mm, and when it is S1A, the terminal length of standard capacitor is 5.8±1.0mm.

Multiplier for Ripple Current

Freq. (Hz)	50	60	120	1K	10K~100K
160~250V	0.85	0.88	1.00	1.30	1.50
315~450V	0.88	0.9	1.00	1.35	1.45

Jamicon Series : HM

Teapo Series : LS

STANDARD RATINGS

Rated Voltage (SurageVoltage) (V)	Cap (μ F)	Case size Φ DxL(mm)	tan δ	Ripple current (A/rms105°C) (120Hz)	Rated Voltage (SurageVoltage) (V)	Cap (μ F)	Case size Φ DxL(mm)	tan δ	Ripple current (A/rms105°C) (120Hz)
160 (200)	560	22x30	0.15	1.48	250 (300)	470	22x35	0.15	1.29
	680	22x35	0.15	1.65			25x30	0.15	1.36
		25x30	0.15	1.70		560	22x40	0.15	1.40
	820	22x40	0.15	2.00			25x35	0.15	1.50
		25x35	0.15	2.00			30x25	0.15	1.44
	1000	22x50	0.15	2.10		680	22x45	0.15	1.61
		25x40	0.15	2.20			25x40	0.15	1.73
		30x30	0.15	2.20			30x30	0.15	1.71
	1200	25x45	0.15	2.30		820	25x45	0.15	2.00
		30x35	0.15	2.30			30x35	0.15	2.00
	1500	25x50	0.15	2.50			35x30	0.15	2.00
		30x40	0.15	2.50		25x50	0.15	2.20	
			35x30	0.15		2.50	30x40	0.15	2.20
	1800	30x45	0.15	2.70		1000	35x30	0.15	2.00
35x35		0.15	2.55	30x45	0.15		2.35		
2200	30x50	0.15	2.90	35x35	0.15		2.32		
	35x45	0.15	2.90	1200	35x40	0.15	2.32		
2700	35x50	0.15	3.25	1800	35x50	0.15	2.71		
3300	35x60	0.15	3.87	400 (450)	120	22x25	0.15	0.63	
200 (250)	470	22x30	0.15		1.44	180	22x30	0.15	0.80
	560	22x35	0.15		1.50	25x25	0.15	0.79	
		25x30	0.15		1.51	220	22x35	0.15	0.94
	680	22x40	0.15		1.84		25x30	0.15	0.94
		25x35	0.15		1.77	270	22x40	0.15	1.04
	820	22x45	0.15		2.05		25x35	0.15	1.06
		25x40	0.15		1.99		30x25	0.15	1.03
		30x30	0.15		1.96	330	22x50	0.15	1.27
	1000	25x45	0.15		2.37		25x40	0.15	1.24
		30x35	0.15		2.41		30x30	0.15	1.22
	1200	25x50	0.15		2.54		35x25	0.15	1.25
		30x40	0.15		2.43	25x45	0.15	1.41	
		35x30	0.15		2.49	390	30x35	0.15	1.42
	1500	30x45	0.15	2.57	35x30		0.15	1.55	
1800		35x35	0.15	2.57	470	30x40	0.15	1.55	
	30x50	0.15	2.70	35x30	0.15	1.51			
	35x40	0.15	2.82	560	30x45	0.15	1.68		
2200	35x45	0.15	3.16		35x35	0.15	1.66		
2700	35x55	0.15	3.60	680	30x50	0.15	1.93		
220 (270)	330	22x25	0.15	1.26	820	35x40	0.15	1.92	
	390	22x30	0.15	1.34	420(470)	120	22x25	0.20	0.46
	470	22x35	0.15	1.48		150	22x30	0.20	0.54
		25x30	0.15	1.40		25x25	0.20	0.65	
	560	22x40	0.15	1.45		180	22x35	0.20	0.64
		25x30	0.15	1.45			25x30	0.20	0.64
	680	22x40	0.15	1.49			22x40	0.20	0.80
		25x35	0.15	1.78		220	25x35	0.20	0.80
		30x30	0.15	1.65			30x25	0.20	0.80
	820	22x50	0.15	1.93			270	22x50	0.20
		25x40	0.15	1.93		25x40		0.20	1.00
		30x30	0.15	1.85		30x30		0.20	1.00
		35x25	0.15	1.93		330	25x45	0.20	1.10
	25x45	0.15	2.15	30x35			0.20	1.10	
1000	30x35	0.15	2.33	35x30			0.20	1.10	
	35x30	0.15	2.33	25x50	0.20		1.20		
1200	30x40	0.15	2.50	390	30x40	0.20	1.20		
	35x30	0.15	2.12		35x30	0.20	1.20		
1500	30x45	0.15	2.30	470	30x45	0.20	1.30		
	35x35	0.15	2.25		35x35	0.20	1.30		
1800	35x40	0.15	2.43		30x50	0.20	1.60		
2200	35x50	0.15	2.95	680	35x45	0.20	2.00		
250 (300)	390	22x30	0.15	1.15					
		25x25	0.15	1.21					

Jamicon Series : HM

Teapo Series : LS

■ STANDARD RATINGS

Rated Voltage (SurageVoltage) (V)	Cap (μF)	Case size Φ D \times L(mm)	tan δ	Ripple current (A/rms105°C) (120Hz)
420(470)	820	35x50	0.20	2.30
450 (500)	100	22x25	0.20	0.54
	120	22x30	0.20	0.63
	150	22x35	0.20	0.76
		25x25	0.20	0.73
	180	22x40	0.20	0.84
		25x30	0.20	0.80
	220	22x45	0.20	0.97
		25x35	0.20	0.94
		30x25	0.20	0.91
	270	22x50	0.20	1.07
25x40		0.20	1.04	

Rated Voltage (SurageVoltage) (V)	Cap (μF)	Case size Φ D \times L(mm)	tan δ	Ripple current (A/rms105°C) (120Hz)
450 (500)	270	30x35	0.20	1.10
		35x25	0.20	1.16
	330	25x50	0.20	1.27
		30x35	0.20	1.21
		35x30	0.20	1.25
	390	30x40	0.20	1.39
		35x35	0.20	1.44
	470	30x45	0.20	1.52
		35x35	0.20	1.50
	560	35x40	0.20	1.63
	680	35x50	0.20	1.97

Jamicon Series : LR

Teapo Series : LR Downsized · Low profile Series



- Endurance: 105°C 2000 hours
- Recommended Applications : Applying to switching power supply and other industry/ commercial field
- Corresponding product to RoHS

■ SPECIFICATIONS

Item	Characteristics								
Category Temperature Range	-25 ~ +105°C								
Rated Voltage Range	400 ~ 450VDC								
Rated Capacitance Range	120 ~ 1000 μF								
Capacitance Tolerance	± 20 % (120Hz , 20°C)								
Leakage Current (20°C)	$I = \sqrt[3]{CV}$. (After rated voltage applied for 5 minutes) I : Max. leakage current (μA), C : Nominal capacitance (μF), V : Rated voltage (V)								
Dissipation Factor(MAX) (tan δ) (120Hz ,20°C)	<table border="1"> <tr> <td>WV</td> <td>400</td> <td>420</td> <td>450</td> </tr> <tr> <td>tan δ</td> <td>0.15</td> <td>0.20</td> <td>0.20</td> </tr> </table>	WV	400	420	450	tan δ	0.15	0.20	0.20
WV	400	420	450						
tan δ	0.15	0.20	0.20						
Low Temperature Stability Impedance Ratio (MAX)	Measurement frequency : 120Hz <table border="1"> <tr> <td>WV</td> <td>400</td> <td>420</td> <td>450</td> </tr> <tr> <td>Z-25°C / Z+20°C</td> <td>8</td> <td>8</td> <td>8</td> </tr> </table>	WV	400	420	450	Z-25°C / Z+20°C	8	8	8
WV	400	420	450						
Z-25°C / Z+20°C	8	8	8						
Endurance	After applying rated voltage with rated Ripple current for 2000hrs at 105°C,the capacitor shall meet the following requirements. <table border="1"> <tr> <td>Capacitance change</td> <td>Within ± 20% of initial value</td> </tr> <tr> <td>D.F. (tan δ)</td> <td>Not more than 200% of specified value</td> </tr> <tr> <td>Leakage current</td> <td>initial specified value or less</td> </tr> </table>	Capacitance change	Within ± 20% of initial value	D.F. (tan δ)	Not more than 200% of specified value	Leakage current	initial specified value or less		
Capacitance change	Within ± 20% of initial value								
D.F. (tan δ)	Not more than 200% of specified value								
Leakage current	initial specified value or less								
Shelf Life	The following specifications shall be satisfied when the capacitors are restored to 20°C after exposing them for 1,000 hours at 105°C without voltage applied. Before the measurement, the capacitor shall be preconditioned by applying voltage according to item 4.1 of JIS C 5101-4.								

■ Dimensions [mm]

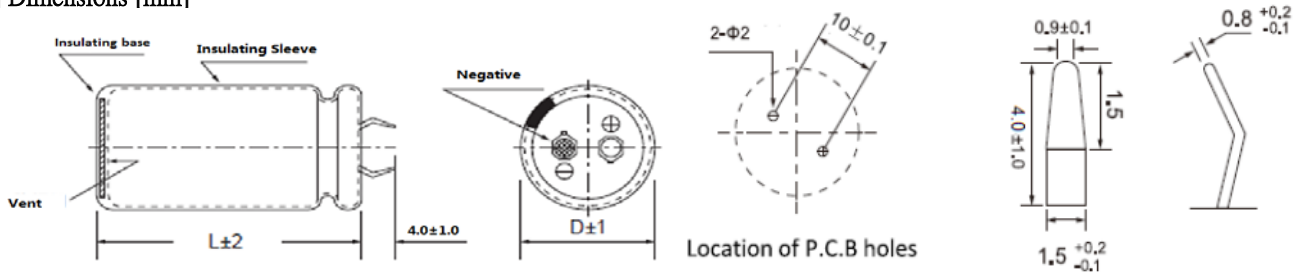

※When the code 11~13 of part number is S1G, the terminal length of standard capacitor is 4.0±1.0mm, and when it is S1A, the terminal length of standard capacitor is 5.8±1.0mm.

■ Multiplier for Ripple Current

Freq. (Hz)	50	120	300	1K	10K	≥ 50K
400~450V	0.77	1	1.16	1.30	1.41	1.43

Jamicon Series : LR

Teapo Series : LR

■ STANDARD RATINGS

Rated Voltage (SurageVoltage) (V)	Cap (μ F)	Case size Φ D \times L(mm)	$\tan \delta$	Ripple current (A/rms105°C) (120Hz)	Rated Voltage (SurageVoltage) (V)	Cap (μ F)	Case size Φ D \times L(mm)	$\tan \delta$	Ripple current (A/rms105°C) (120Hz)		
400 (450)	150	22x25	0.15	0.57	420(470)	470	25x50	0.20	1.28		
	180	22x30	0.15	0.68			30x35	0.20	1.22		
	220	22x35	0.15	0.80			35x30	0.20	1.25		
		25x25	0.15	0.75		560	30x40	0.20	1.40		
	270	22x40	0.15	0.94			35x35	0.20	1.45		
		25x30	0.15	0.89		680	30x50	0.20	1.70		
	330	22x45	0.15	1.09			35x40	0.20	1.69		
		25x35	0.15	1.05		820	30x55	0.20	1.95		
		30x25	0.15	1.02			35x45	0.20	1.95		
	390	22x50	22x50	0.15		1.25	450 (500)	120	22x25	0.20	0.55
			25x40	0.15		1.21		180	22x30	0.20	0.72
			30x30	0.15		1.20		220	25x25	0.20	0.72
			35x25	0.15		1.23			22x35	0.20	0.85
		470	25x45	0.15		1.40		270	25x30	0.20	0.86
			30x35	0.15		1.40			22x45	0.20	1.06
		560	30x40	0.15		1.62			25x35	0.20	1.02
35x30			0.15	1.58	30x25	0.20		0.99			
680	30x45	0.15	1.87	330	22x50	0.20		1.23			
	35x35	0.15	1.85		25x40	0.20		1.19			
820	35x40	0.15	2.14		30x30	0.20		1.18			
	1000	35x50	0.15	2.50	25x45	0.20		1.37			
420(470)	150	22x25	0.20	0.50	390	30x35		0.20	1.36		
		22x30	0.20	0.59		35x30		0.20	1.41		
		25x25	0.20	0.59		470		25x50	0.20	1.57	
	220	22x35	0.20	0.69	30x40			0.20	1.58		
		22x40	0.20	0.81	35x35		0.20	1.64			
	270	25x30	0.20	0.78	560	30x45	0.20	1.82			
		30x25	0.20	0.80		35x40	0.20	1.89			
	330	22x45	0.20	0.95	680	30x50	0.20	2.09			
		25x35	0.20	0.92		35x45	0.20	2.16			
	390	25x40	0.20	1.05	820	30x60	0.20	2.49			
		30x30	0.20	1.04		35x50	0.20	2.51			

Jamicon Series : LM

Teapo Series : LM

Downsized · Low profile · Long Life Series



- Endurance: 105°C 3000hours
- Recommended Applications : Smoothing circuit, TV/Monitor,Adapter, SMPS
- Corresponding product to RoHS

■ SPECIFICATIONS

Item	Characteristics			
Category Temperature Range	-25 ~ +105°C			
Rated Voltage Range	400 ~ 450VDC			
Rated Capacitance Range	82 ~ 1000 µF			
Capacitance Tolerance	± 20 % (120Hz , 20°C)			
Leakage Current (20°C)	I = √ CV. (After rated voltage applied for 5 minutes) I : Max. leakage current (µA), C : Nominal capacitance (µF), V : Rated voltage (V)			
Dissipation Factor(MAX) (tan δ) (120Hz ,20°C)	WV	400	420	450
	tan δ	0.15	0.20	0.20
Low Temperature Stability Impedance Ratio (MAX)	Measurement frequency : 120Hz			
	Rated voltage(V)	400	420	450
	Z-25°C / Z+20°C	4	8	8
	Z-40°C / Z+20°C	—	—	—
Endurance	After applying rated voltage with rated Ripple current for 3000hrs at 105°C, the capacitor shall meet the following requirement.			
	Capacitance change	Within ± 20% of initial value		
	D.F. (tan δ)	Not more than 200% of specified value		
	Leakage current	Not more than the specified value		
Shelf Life	The following specifications shall be satisfied when the capacitors are restored to 20°C after exposing them for 1,000 hours at 105°C without voltage applied. Before the measurement, the capacitor shall be preconditioned by applying voltage according to item 4.1 of JIS C 5101-4.			

■ Dimensions [mm]

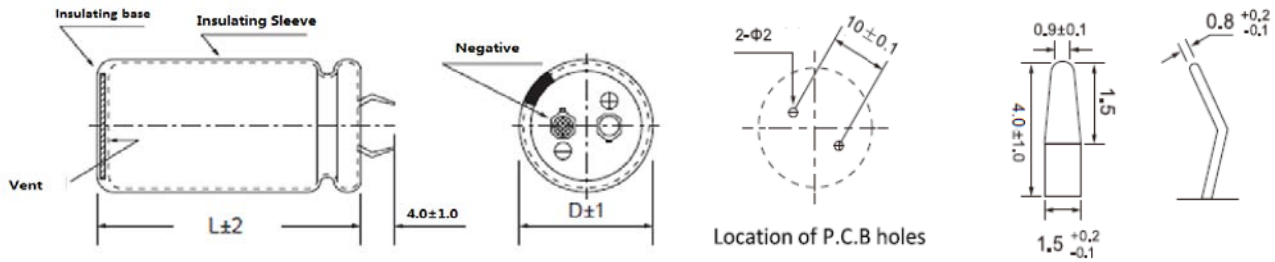

※When the code 11~13 of part number is S1G, the terminal length of standard capacitor is 4.0±1.0mm, and when it is S1A, the terminal length of standard capacitor is 5.8±1.0mm.

■ Multiplier for Ripple Current

Freq. (Hz)	50	120	300	1K	10K	50K
400~450V	0.77	1.00	1.16	1.30	1.41	1.43

Jamicon Series : LM

Teapo Series : LM

■ STANDARD RATINGS

Rated Voltage (SurageVoltage) (V)	Cap (μ F)	Case size Φ DxL(mm)	$\tan \delta$	Ripple current (A/rms105°C) (120Hz)	Rated Voltage (SurageVoltage) (V)	Cap (μ F)	Case size Φ DxL(mm)	$\tan \delta$	Ripple current (A/rms105°C) (120Hz)
400 (450)	120	22x25	0.15	0.77	420(470)	330	35x30	0.20	1.55
	150	22x30	0.15	0.9		390	30x45	0.20	1.70
	180	22x35	0.15	1.02		470	35x35	0.20	1.71
		25x25	0.15	0.99			30x50	0.20	1.90
	220	22x40	0.15	1.15		35x40	0.20	1.95	
		25x30	0.15	1.13		560	35x45	0.20	2.17
	270	22x45	0.15	1.29	680	35x50	0.20	2.45	
			25x35	0.15	1.30	450 (500)	82	22x25	0.20
		30x25	0.15	1.29	120		22x30	0.20	0.81
	22x50	0.15	1.47	22x35			0.20	0.83	
	330	25x40	0.15	1.47			25x25	0.20	0.81
		30x30	0.15	1.45	150		22x40	0.20	0.94
		35x25	0.15	1.52			25x30	0.20	0.93
	390	25x45	0.15	1.63	180		22x45	0.20	1.06
			25x50	0.15			1.66	25x35	0.20
		30x35	0.15	1.61			30x25	0.20	1.06
	470	30x40	0.15	1.82	220		22x50	0.20	1.20
		35x30	0.15	1.85		25x40	0.20	1.20	
	560	30x45	0.15	2.04		30x30	0.20	1.18	
		30x50	0.15	2.07		35x25	0.20	1.24	
35x35		0.15	2.05	270	25x45	0.20	1.36		
680	35x40	0.15	2.34		25x50	0.20	1.38		
	35x45	0.15	2.40		30x35	0.20	1.34		
820	35x50	0.15	2.69		35x30	0.20	1.40		
1000	35x60	0.15	2.75	330	30x40	0.20	1.52		
420(470)	220	22x45	0.20	1.17	390	30x45	0.20	1.70	
		22x50	0.20	1.20		30x50	0.20	1.73	
		25x35	0.20	1.18		35x35	0.20	1.71	
		30x30	0.20	1.18		470	35x40	0.20	1.95
	270	25x40	0.20	1.33	35x45		0.20	1.99	
		25x45	0.20	1.36	560	35x50	0.20	2.22	
		35x25	0.20	1.38		680	35x55	0.20	2.30
	330	25x50	0.20	1.52		820	35x60	0.20	2.42
		30x35	0.20	1.48		1000	35x65	0.20	2.77
		30x40	0.20	1.52					

Jamicon Series : LA

Teapo Series : LA

Charge-Discharge Facility Series



- Endurance:105°C 3000 hours
- Suitable for high frequency of regenerative voltage of AC servo motor and general inverter
- Most suitable for high frequency power on/off applications and applications where the power supply voltage varies greatly
- Can withstand DC charge and discharge for 50 million cycles
- Corresponding product to RoHS

SPECIFICATIONS

Item	Characteristics			
Category Temperature Range	-25 ~ +105°C			
Rated Voltage Range	350~ 450VDC			
Rated Capacitance Range	100 ~ 820 μF			
Capacitance Tolerance	± 20 % (120Hz , 20°C)			
Leakage Current (20°C)	$I = \sqrt{CV}$. (After rated voltage applied for 5minutes) I : Max. leakage current (μA), C : Nominal capacitance (μF), V : Rated voltage (V)			
Dissipation Factor(MAX) (tan δ) (120Hz ,20°C)	WV	350~400	420~450	
	tan δ	0.15	0.20	
Charge discharge condition	Frequency	6Hz		
	Cycle	50 million cycles		
Voltage waveform				
	<p>0V</p>			
Low Temperature Stability Impedance Ratio (MAX)	Measurement frequency : 120Hz			
	Rated voltage(V)	350	400	420
Z-25°C / Z+20°C	8	8	8	8
Endurance	After applying rated voltage with rated Ripple current for 3000hrs at 105°C, the capacitor shall meet the following requirement.			
	Capacitance change	Within ± 20% of initial value		
	D.F. (tan δ)	Not more than 200% of specified value		
Leakage current	Not more than the specified value			
Shelf Life	The following specifications shall be satisfied when the capacitors are restored to 20°C after exposing them for 1,000 hours at 105°C without voltage applied. Before the measurement, the capacitor shall be preconditioned by applying voltage according to item 4.1 of JIS C 5101-4.			

Dimensions [mm]

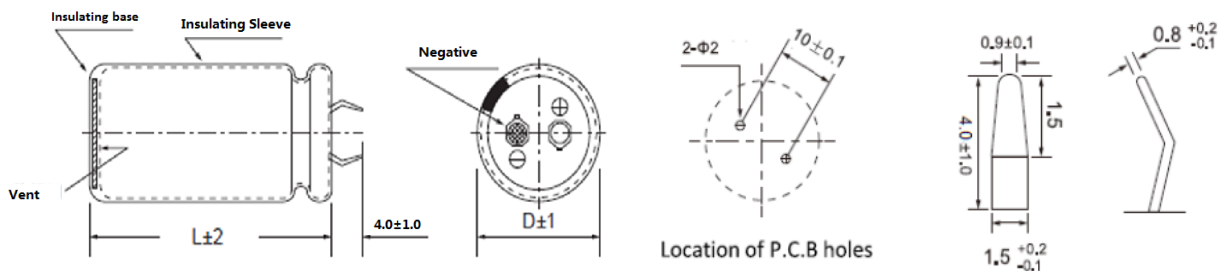

※When the code 11~13 of part number is S1G, the terminal length of standard capacitor is 4.0±1.0mm, and when it is S1A, the terminal length of standard capacitor is 5.8±1.0mm.

Multiplier for Ripple Current

Freq. (Hz)	50	120	300	1K	10K	≥ 50K
350~450V	0.77	1.00	1.16	1.30	1.41	1.43

Jamicon Series : LA

Teapo Series : LA

■ STANDARD RATINGS

Rated Voltage (SurageVoltage) (V)	Cap (μ F)	Case size Φ DxL(mm)	$\tan \delta$	Ripple current (A/rms105°C) (120Hz)	Rated Voltage (SurageVoltage) (V)	Cap (μ F)	Case size Φ DxL(mm)	$\tan \delta$	Ripple current (A/rms105°C) (120Hz)
350(400)	120	22x25	0.15	0.75	420(470)	100	22x25	0.20	0.66
	150	22x30	0.15	0.82		120	22x30	0.20	0.81
	180	25x25	0.15	0.90		150	25x25	0.20	0.81
	220	22x35	0.15	1.00		150	22x35	0.20	0.84
		25x30	0.15	1.00			25x30	0.20	0.84
	270	22x40	0.15	1.10		180	22x40	0.20	0.91
		25x35	0.15	1.10			25x30	0.20	0.91
		30x25	0.15	1.10			30x25	0.20	0.91
	330	22x45	0.15	1.20		220	22x45	0.20	1.05
		25x40	0.15	1.20			25x35	0.20	1.05
		30x30	0.15	1.20			30x30	0.20	1.05
	390	25x45	0.15	1.30		270	25x40	0.20	1.25
		30x35	0.15	1.30			30x30	0.20	1.25
	470	25x50	0.15	1.40		330	35x25	0.20	1.25
		30x40	0.15	1.40			25x50	0.20	1.42
		35x30	0.15	1.40			30x35	0.20	1.42
560	30x45	0.15	1.50	390	35x30	0.20	1.42		
	35x35	0.15	1.50		30x40	0.20	1.61		
680	30x50	0.15	1.70	470	35x35	0.20	1.61		
	35x40	0.15	1.70		30x45	0.20	1.86		
820	35x45	0.15	1.90	35x40	0.20	1.86			
400(450)	100	22x25	0.15	0.68	560	35x45	0.20	1.98	
	120	22x30	0.15	0.73	680	35x50	0.20	2.20	
	150	22x35	0.15	0.85	450(500)	100	22x30	0.20	0.69
	180	22x35	0.15	0.95		120	22x25	0.20	0.69
		25x30	0.15	0.95			22x35	0.20	0.72
	220	30x25	0.15	0.95		150	22x40	0.20	0.79
		22x45	0.15	1.10			25x30	0.20	0.79
		25x35	0.15	1.10			30x25	0.20	0.79
	270	30x25	0.15	1.10		180	22x45	0.20	0.87
		22x50	0.15	1.22			25x35	0.20	0.87
		25x40	0.15	1.22			30x30	0.20	0.87
		30x30	0.15	1.22			25x40	0.20	1.05
	330	35x25	0.15	1.22		220	30x30	0.20	1.05
		25x45	0.15	1.44			35x25	0.20	1.05
		30x35	0.15	1.44			25x50	0.20	1.23
	390	25x50	0.15	1.55		270	30x35	0.20	1.23
30x40		0.15	1.55	35x30			0.20	1.23	
470	35x30	0.15	1.55	330		30x40	0.20	1.38	
	30x45	0.15	1.68		35x35	0.20	1.38		
560	35x35	0.15	1.68	390	30x50	0.20	1.61		
	30x50	0.15	1.90		35x40	0.20	1.61		
680	35x40	0.15	1.90	470	35x45	0.20	1.78		
680	35x50	0.15	2.12	560	35x50	0.20	1.99		

Jamicon Series : HV

Teapo Series : GD

No Spark with DC Overvoltage Series

■ Endurance: 105°C 3000hours

■ Recommended Applications: Smoothing circuit, TV/Monitor, Adapter, SMPS

■ Corresponding product to RoHS

■ SPECIFICATIONS



Item	Characteristics		
Category Temperature Range	-25 ~ +105°C		
Rated Voltage Range	200~400 VDC		
Rated Capacitance Range	68~1500 μ F		
Capacitance Tolerance	$\pm 20\%$ (120Hz, 20°C)		
Leakage Current (20°C)	$I = \sqrt[3]{CV}$. (After rated voltage applied for 5 minutes) I : Max. leakage current (μ A), C : Nominal capacitance (μ F), V : Rated voltage (V)		
Dissipation Factor(MAX) (tan δ) (120Hz, 20°C)	WV	200	400
	tan δ	0.15	0.15
Low Temperature Stability Impedance Ratio (MAX)	Measurement frequency : 120Hz		
	Rated voltage(V) Z-25°C / Z+20°C	200	400
Endurance	After applying rated voltage with rated ripple current for 3000 hours at 105°C, the capacitors shall meet the following requirements.		
	Capacitance change	Within $\pm 20\%$ of initial value	
	D.F. (tan δ)	Not more than 200% of specified value	
Shelf Life	Leakage current	Not more than the specified value	
	The following specifications shall be satisfied when the capacitors are restored to 20°C after exposing them for 1,000 hours at 105°C without voltage applied. Before the measurement, the capacitor shall be preconditioned by applying voltage according to item 4.1 of JIS C 5101-4.		

■ Dimensions [mm]

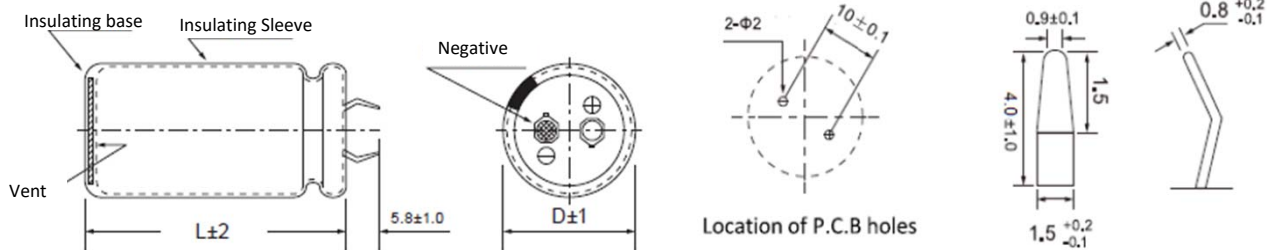

■ Multiplier for Ripple Current

Freq. (Hz)	60	120	400	1K	10K
200V	0.80	1.00	1.10	1.30	1.40
400WV	0.80	1.00	1.10	1.30	1.40

Jamicon Series : HV

Teapo Series : GD

■ **STANDARD RATINGS**

Rated Voltage (Surge Voltage) (V)	Cap (μF)	Case size Φ D×L(mm)	tan δ	Ripple current (A/rms105°C) (120Hz)	Rated Voltage (Surge Voltage) (V)	Cap (μF)	Case size Φ D×L(mm)	tan δ	Ripple current (A/rms105°C) (120Hz)
200V (250)	270	22x25	0.15	0.89	400V (450)	82	25x25	0.15	0.52
	330	22x30	0.15	1.06		100	22x35	0.15	0.65
		25x25	0.15	1.01			25x30	0.15	0.62
	390	22x35	0.15	1.24		120	22x40	0.15	0.76
		25x30	0.15	1.18			25x30	0.15	0.68
	470	22x40	0.15	1.44			30x25	0.15	0.67
		25x30	0.15	1.30		150	22x45	0.15	0.89
		30x25	0.15	1.34			25x35	0.15	0.82
	560	22x45	0.15	1.65			30x30	0.15	0.81
		25x35	0.15	1.51		180	22x50	0.15	1.03
		30x30	0.15	1.58			25x40	0.15	0.95
	680	22x50	0.15	1.91			30x30	0.15	0.89
		25x40	0.15	1.76			35x25	0.15	0.91
		30x35	0.15	1.85		220	25x45	0.15	1.11
	820	25x50	0.15	2.13			30x35	0.15	1.04
	30x35	0.15	2.03		35x30	0.15	1.08		
	35x30	0.15	2.03	270	25x50	0.15	1.28		
1000	30x45	0.15	2.50		30x40	0.15	1.22		
	35x35	0.15	2.38		35x35	0.15	1.27		
1200	30x50	0.15	2.86		30x45	0.15	1.42		
	35x40	0.15	2.75	330	35x35	0.15	1.40		
1500	35x45	0.15	3.11		30x50	0.15	1.62		
400V (450)	68	22x25	0.15	0.46	390	35x40	0.15	1.61	
	82	22x30	0.15	0.55	470	35x45	0.15	1.86	

■ **DC OVERVOLTAGE TEST CONDITION**

The vent will be operated and the capacity shall become an open circuit without burning the material when the following excess DC voltage is applied.

Rated Voltage	Capacitance	Current	Test DC Voltage
200VDC	< 330 μF	4A	300/375 VDC
	330 ≤ C < 470 μF	5A	
	≥ 470 μF	7A	
400VDC	< 100 μF	2A	500/600 VDC
	100 ≤ C < 220 μF	4A	
	≥ 220 μF	7A	

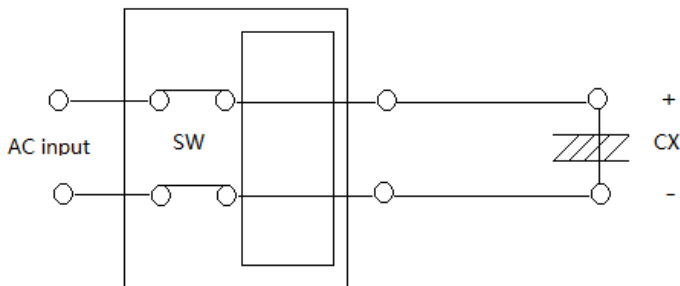

Constant DC voltage/current power supply

Jamicon Series : KP

Teapo Series : KP Standard Series

- Endurance:85°C 2000hours
- Recommended Applications :UPS、service system、press working equipment、charging equipment、inverter、converter
- Corresponding product to RoHS



■ SPECIFICATIONS

Item	Characteristics											
Category Temperature Range	-40 ~ +85°C	-25 ~ +85°C										
Rated Voltage Range	6.3~ 100VDC	160~450VDC										
Capacitance Tolerance	± 20 % (120Hz, 20°C)											
Leakage Current (20°C)	I ≤ 0.02CV or 5mA whichever is greater. (After rated voltage applied for 5 minutes) I : Max. leakage current (μA), C : Nominal capacitance (μF), V : Rated voltage (V)											
Dissipation Factor(MAX) (tan δ) (120Hz, 20°C)	WV	6.3~10	16	25	35	50	63	80	100	160~250	350~450	
	tan δ	φ 35	0.75	0.60	0.40	0.30	0.25	0.20	0.20	0.15	0.15	0.20
		φ 51	1.00	0.70	0.50	0.50	0.30	0.25	0.20	0.20	0.15	0.20
		φ 64	1.30	0.80	0.70	0.60	0.50	0.30	0.25	0.25	0.20	0.25
		φ 77	1.50	1.00	0.80	0.70	0.60	0.40	0.30	0.25	0.20	0.25
φ 90	1.50	1.00	0.80	0.70	0.60	0.40	0.30	0.25	0.20	0.25		
Low Temperature Stability Impedance Ratio (MAX)	Measurement frequency : 120Hz		Rated voltage(V)		10~100	160~450						
	Z-25°C / Z+20°C				-	8						
	Z-40°C / Z+20°C				12	-						
Endurance	After applying rated voltage with ripple current for 2000 hours at 85°C, the capacitors shall meet the following requirements.											
	Capacitance change		Within ± 15% of initial value									
	D.F. (tan δ)		Not more than 175% of specified value									
Shelf Life	Leakage current		Not more than the specified value									
	The following specifications shall be satisfied when the capacitors are restored to 20°C after exposing them for 1,000 hours at 105°C without voltage applied. Before the measurement, the capacitor shall be preconditioned by applying voltage according to item 4.1 of JIS C 5101-4.											

■ Dimensions [mm]

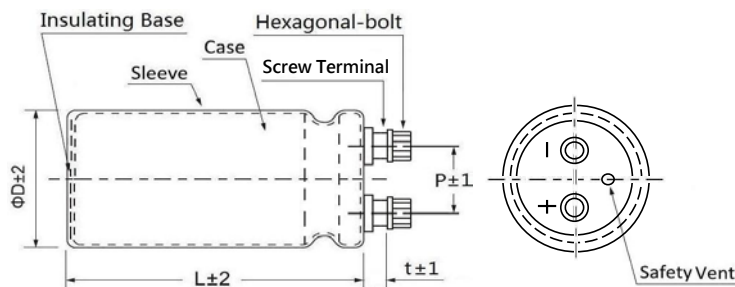

ΦD	P	t	Hexagonal-bolt
35	12.7	6.3	M5 × 0.8 × 10
51	21.8	6.3	M5 × 0.8 × 10
64	28.2	6.3	M5 × 0.8 × 10
77	31.4	5.8	M5 × 0.8 × 10
90	31.4	5.8	M5 × 0.8 × 10

■ Multiplier for Ripple Current

Freq. (Hz)	60	120	1K	10K	100K
W.V	coefficient				
6.3~35V	0.90	1.00	1.05	1.10	1.10
50~100V	0.90	1.00	1.10	1.15	1.15
160~450V	0.80	1.00	1.20	1.40	1.40

Temperature	≤ 60	70	85
coefficient	1.8	1.6	1.00

Jamicon Series : KP

Teapo Series : KP

■ STANDARD RATINGS

Rated Voltage (Surge Voltage) (V)	Cap (μF)	Case size Φ D×L(mm)	tan δ	R.C (A/rms,85°C) (120Hz)	Rated Voltage (Surge Voltage) (V)	Cap (μF)	Case size Φ D×L(mm)	tan δ	R.C (A/rms,85°C) (120Hz)
6.3 (8)	47000	35x50	0.75	4.94	35(44)	10000	35x50	0.30	3.53
	56000	35x60	0.75	4.96		12000	35x50	0.30	3.87
	68000	35x60	0.75	5.47		15000	35x60	0.30	3.96
	82000	35x80	0.75	6.82		18000	35x60	0.30	4.34
	100000	35x80	0.75	7.53		22000	35x80	0.30	4.93
	120000	35x121	0.75	9.15		27000	35x80	0.30	5.46
	150000	51x80	1.00	9.51		33000	35x121	0.30	7.20
	180000	51x80	1.00	10.42		39000	35x121	0.30	7.83
	220000	51x100	1.00	12.39		47000	51x80	0.50	8.26
	270000	64x100	1.30	13.68		56000	51x80	0.50	9.02
	330000	64x100	1.30	15.12		68000	51x100	0.50	10.35
	390000	64x121	1.30	16.97		82000	51x100	0.50	11.36
	470000	64x121	1.30	18.63		100000	64x100	0.60	11.48
	560000	77x121	1.50	18.80		120000	64x121	0.60	13.13
680000	77x121	1.50	20.71	150000	64x144	0.60	15.42		
10 (13)	33000	35x50	0.75	4.14	180000	64x144	0.60	16.89	
	39000	35x50	0.75	4.50	220000	77x144	0.70	17.79	
	47000	35x60	0.75	5.35	50(63)	6800	35x50	0.25	3.26
	56000	35x80	0.75	6.63		8200	35x50	0.25	3.58
	68000	35x80	0.75	7.31		10000	35x60	0.25	4.27
	82000	35x80	0.75	8.02		12000	35x60	0.25	4.68
	100000	35x121	0.75	9.21		15000	35x80	0.25	5.94
	120000	51x80	1.00	9.23		18000	35x80	0.25	6.51
	150000	51x80	1.00	10.32		22000	35x121	0.25	6.70
	180000	51x90	1.00	11.50		27000	35x121	0.25	7.42
	220000	51x121	1.00	13.66		33000	51x80	0.30	7.55
	270000	51x121	1.00	15.13		39000	51x80	0.30	8.20
	330000	64x121	1.30	17.25		47000	51x100	0.30	9.80
	390000	64x121	1.30	18.75		56000	51x100	0.30	10.70
470000	77x121	1.50	19.25	68000		64x100	0.50	11.34	
560000	77x121	1.50	21.01	82000		64x100	0.50	12.46	
16 (20)	22000	35x50	0.60	4.16	100000	64x144	0.50	12.81	
	33000	35x60	0.60	5.51	120000	64x144	0.50	14.03	
	39000	35x80	0.60	6.80	150000	77x144	0.60	15.86	
	47000	35x80	0.60	7.47	63 (79)	5600	35x50	0.20	2.97
	56000	35x100	0.60	9.03		6800	35x50	0.20	3.28
	68000	35x121	0.60	9.88		8200	35x60	0.20	3.89
	82000	35x121	0.60	10.85		10000	35x80	0.20	4.77
	100000	51x80	0.70	10.86		12000	35x80	0.20	5.23
	120000	51x90	0.70	11.74		15000	35x100	0.20	5.88
	150000	51x121	0.70	12.48		18000	35x121	0.20	6.16
	180000	51x121	0.70	13.67		22000	51x80	0.25	7.73
	220000	64x100	0.80	14.75		27000	51x80	0.25	8.56
	270000	64x115	0.80	17.37		33000	51x100	0.25	8.76
	330000	77x121	1.00	18.19		39000	51x121	0.25	10.22
390000	77x121	1.00	19.78	47000		64x100	0.30	11.88	
25(32)	18000	35x50	0.40	3.35		56000	64x100	0.30	12.96
	22000	35x60	0.40	4.01		68000	64x144	0.30	13.63
	27000	35x80	0.40	5.04	100000	77x144	0.40	15.86	
	33000	35x80	0.40	5.58	80 (100)	4700	35x50	0.20	2.72
	39000	35x80	0.40	6.06		5600	35x60	0.20	3.22
	47000	35x121	0.40	7.54		6800	35x80	0.20	4.03
	56000	35x121	0.40	8.23		8200	35x80	0.20	4.42
	68000	51x100	0.50	9.13		10000	35x100	0.20	5.41
	82000	51x100	0.50	10.03		12000	35x121	0.20	6.47
	100000	51x121	0.50	11.27		15000	51x80	0.20	7.63
	120000	51x121	0.50	12.33		18000	51x80	0.20	8.35
	150000	64x100	0.70	12.69		22000	51x100	0.20	8.76
	180000	64x100	0.70	13.89		27000	51x100	0.20	9.70
	220000	64x144	0.70	16.05		33000	64x100	0.25	10.22
270000	77x115	0.80	17.80	39000		64x100	0.25	11.11	
330000	77x144	0.80	20.38	47000		64x144	0.25	14.33	

Jamicon Series : KP

Teapo Series : KP

■ STANDARD RATINGS

Rated Voltage (Surge Voltage) (V)	Cap (μ F)	Case size Φ DxL(mm)	$\tan \delta$	R.C (A/rms,85°C) (120Hz)	Rated Voltage (Surge Voltage) (V)	Cap (μ F)	Case size Φ DxL(mm)	$\tan \delta$	R.C (A/rms,85°C) (120Hz)
80 (100)	56000	64x144	0.25	15.64	250 (300)	820	35x60	0.15	2.37
	68000	77x144	0.30	16.27		1000	35x80	0.15	2.87
100 (125)	2200	35x50	0.15	2.15		1200	35x80	0.15	3.15
	2700	35x50	0.15	2.38		1500	35x100	0.15	3.49
	3300	35x50	0.15	2.64		1800	35x100	0.15	3.83
	3900	35x60	0.15	3.10		2200	51x70	0.15	4.28
	4700	35x80	0.15	3.87		2700	51x70	0.15	4.74
	5600	35x80	0.15	4.22		3300	51x90	0.15	5.38
	6800	35x100	0.15	5.15		3900	51x115	0.15	6.23
	8200	35x121	0.15	5.83		4700	64x96	0.20	7.06
	10000	51x80	0.20	6.03		5600	64x96	0.20	7.71
	12000	51x80	0.20	6.60		6800	64x115	0.20	9.19
	15000	51x121	0.20	8.86		8200	64x115	0.20	10.09
	18000	51x121	0.20	9.71		10000	64x130	0.20	11.76
	22000	64x100	0.25	9.79		12000	77x115	0.20	13.01
	27000	64x100	0.25	10.85		15000	77x130	0.20	14.70
33000	64x144	0.25	12.80	18000		77x155	0.20	17.40	
39000	77x115	0.25	13.11	22000		90x157	0.20	20.19	
47000	77x144	0.25	14.81	350 (400)		390	35x50	0.20	1.74
160 (200)	1200	35x50	0.15			2.64	470	35x80	0.20
	1500	35x60	0.15		3.20	560	35x80	0.20	2.57
	1800	35x70	0.15		3.63	680	35x80	0.20	2.83
	2200	35x80	0.15		4.26	820	35x100	0.20	3.18
	2700	35x100	0.15		4.68	1000	35x100	0.20	3.51
	3300	35x121	0.15		5.22	1200	51x70	0.20	3.94
	3900	51x70	0.15		5.70	1500	51x70	0.20	4.41
	4700	51x70	0.15		6.26	1800	51x90	0.20	5.38
	5600	51x90	0.15		7.00	2200	51x90	0.20	5.95
	6800	51x90	0.15		7.72	2700	51x130	0.20	6.91
	8200	51x115	0.15		9.04	3300	51x130	0.20	7.63
	10000	64x96	0.20		10.30	3900	64x115	0.25	8.71
	12000	64x96	0.20		11.29	4700	64x130	0.25	9.81
	15000	64x130	0.20		13.83	5600	77x115	0.25	11.26
	18000	64x130	0.20		15.15	6800	77x130	0.25	13.08
	22000	77x130	0.20		18.57	8200	77x155	0.25	15.53
	27000	77x130	0.20		20.58	10000	90x157	0.25	17.71
	33000	90x131	0.20		23.90	12000	90x157	0.25	19.40
39000	90x157	0.20	28.10		15000	90x196	0.25	23.93	
200 (250)	680	35x50	0.15	1.99	18000	90x236	0.25	28.51	
	820	35x50	0.15	2.19	400 (450)	330	35x80	0.20	1.97
	1000	35x60	0.15	2.62		390	35x80	0.20	2.14
	1200	35x60	0.15	2.87		470	35x80	0.20	2.35
	1500	35x80	0.15	3.52		560	35x80	0.20	2.57
	1800	35x80	0.15	3.85		680	35x100	0.20	2.90
	2200	35x100	0.15	4.23		820	35x100	0.20	3.18
	2700	35x121	0.15	4.72		1000	51x70	0.20	3.60
	3300	51x70	0.15	5.24		1200	51x70	0.20	3.94
	3900	51x70	0.15	5.70		1500	51x90	0.20	4.91
	4700	51x90	0.15	6.42		1800	51x90	0.20	5.38
	5600	51x115	0.15	7.47		2200	51x130	0.20	6.23
	6800	51x130	0.15	8.70		2700	64x96	0.25	7.09
	8200	64x96	0.20	9.33		3300	64x115	0.25	8.01
	10000	64x96	0.20	10.30		3900	64x130	0.25	8.94
	12000	77x96	0.20	12.56		4700	77x115	0.25	10.32
	15000	77x96	0.20	14.04		5600	77x130	0.25	11.87
	18000	77x130	0.20	16.80		6800	77x155	0.25	14.14
22000	77x155	0.20	20.07	8200		90x157	0.25	16.03	
27000	90x131	0.20	21.62	10000		90x157	0.25	17.71	
33000	90x157	0.20	25.85	12000		90x196	0.25	21.40	
250 (300)	470	35x50	0.15	1.66	15000	90x236	0.25	26.02	
	560	35x50	0.15	1.81	450 (500)	270	35x50	0.20	1.45
	680	35x50	0.15	1.99		330	35x80	0.20	1.97

Jamicon Series : KP

Teapo Series : KP

■ STANDARD RATINGS

Rated Voltage (SurageVoltage) (V)	Cap (μ F)	Case size Φ D \times L(mm)	tan δ	R.C (A/rms,85°C) (120Hz)
450 (500)	390	35x80	0.20	2.14
	470	35x80	0.20	2.35
	560	35x100	0.20	2.63
	680	35x100	0.20	2.90
	820	51x70	0.20	3.26
	1000	51x70	0.20	3.60
	1200	51x90	0.20	4.39
	1500	51x115	0.20	5.17
	1800	51x130	0.20	5.64
	2200	64x96	0.25	6.40

Rated Voltage (SurageVoltage) (V)	Cap (μ F)	Case size Φ D \times L(mm)	tan δ	R.C (A/rms,85°C) (120Hz)
450 (500)	2700	64x115	0.25	7.25
	3300	64x130	0.25	8.22
	3900	77x115	0.25	9.40
	4700	77x130	0.25	10.88
	5600	77x155	0.25	12.83
	6800	90x157	0.25	14.60
	8200	90x157	0.25	16.03
	10000	90x196	0.25	19.53
	12000	90x236	0.25	23.28

Jamicon Series : WP

Teapo Series : WP

Standard · High Ripple Series



- Endurance: 85°C 2000hours
- Recommended Applications : UPS · service system · press working equipment · charging equipment · inverter · converter
- Corresponding product to RoHS

SPECIFICATIONS

Item	Characteristics					
Category Temperature Range	-25 ~ +85°C					
Rated Voltage Range	160 ~ 550VDC					
Capacitance Tolerance	± 20 % (120Hz , 20°C)					
Leakage Current (20°C)	I ≤ 0.02CV or 5mA whichever is greater. (After rated voltage applied for 5 minutes) I : Max. leakage current (μA), C : Nominal capacitance (μF), V : Rated voltage (V)					
Dissipation Factor(MAX) (tan δ) (120Hz , 20°C)	WV	160	200	250	350~450	500~550
	tan δ	0.15	0.15	0.15	0.15	0.20
Low Temperature Stability Impedance Ratio (MAX)	Measurement frequency : 120Hz					
	Rated voltage(V)	160~550				
	Z-25°C / Z+20°C	8				
Endurance	After applying rated voltage with ripple current for 2000 hours at 85°C, the capacitors shall meet the following requirements.					
	Capacitance change	Within ± 20% of initial value				
	D.F. (tan δ)	Not more than 200% of specified value				
	Leakage current	Not more than the specified value				
Shelf Life	The following specifications shall be satisfied when the capacitors are restored to 20°C after exposing them for 1,000 hours at 85°C without voltage applied. Before the measurement, the capacitor shall be preconditioned by applying voltage according to item 4.1 of JIS C 5101-4.					

Dimensions [mm]

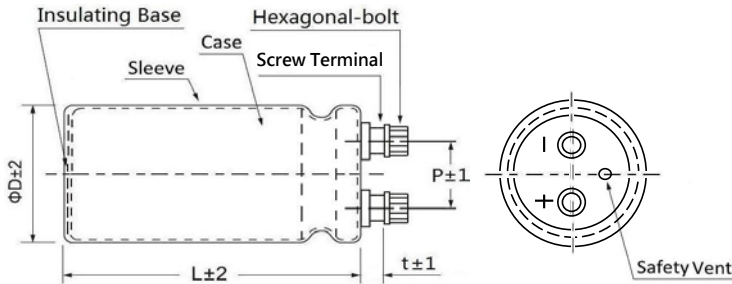

ΦD	P	t	Hexagonal-bolt
51	22.2	6.3	M5 × 0.8 × 10
64	28.5	6.3	M5 × 0.8 × 10
77	31.8	5.8	M5 × 0.8 × 10
90	31.6	5.8	M6 × 1.0 × 10

Multiplier for Ripple Current

Freq. (Hz)	60	120	300	1K	≥ 10K
coefficient	0.70	1.00	1.10	1.30	1.40

Temperature	40	60	85
coefficient	1.89	1.67	1.00

Jamicon Series : WP

Teapo Series : WP

■ STANDARD RATINGS

Rated Voltage (Surage Voltage) (V)	Cap (μ F)	Case size Φ DxL(mm)	$\tan \delta$	Ripple current (A/rms 85°C) (120Hz)	Rated Voltage (Surage Voltage) (V)	Cap (μ F)	Case size Φ DxL(mm)	$\tan \delta$	Ripple current (A/rms 85°C) (120Hz)	
160 (200)	3900	51x75	0.15	7.51	400 (450)	18000	90x236	0.15	40.25	
	4700	51x75	0.15	8.25		1000	51x75	0.15	4.76	
	5600	51x96	0.15	10.02		1200	51x80	0.15	5.36	
	6800	51x96	0.15	11.04		1500	51x96	0.15	6.48	
	8200	51x115	0.15	13.15		1800	51x96	0.15	7.10	
	10000	64x96	0.15	14.27		2200	51x130	0.15	9.00	
	12000	64x96	0.15	15.64		2700	64x96	0.15	9.64	
	15000	64x130	0.15	19.96		3300	64x115	0.15	11.53	
	18000	64x130	0.15	21.87		3900	64x130	0.15	13.23	
	22000	77x130	0.15	25.91			77x96	0.15	11.90	
	27000	77x130	0.15	28.71		4700	77x115	0.15	14.10	
	33000	90x131	0.15	33.60		5600	77x130	0.15	16.23	
	39000	90x157	0.15	39.50		6800	77x155	0.15	19.32	
200 (250)	3300	51x75	0.15	6.91	8200	90x157	0.15	22.64		
	3900	51x75	0.15	7.51	10000	90x157	0.15	25.00		
	4700	51x96	0.15	9.18	12000	90x196	0.15	30.22		
	5600	51x115	0.15	10.86	15000	90x236	0.15	36.74		
	6800	51x130	0.15	12.65	450 (500)	820	51x75	0.15	4.31	
	8200	64x96	0.15	12.93		1000	51x80	0.15	4.89	
	10000	64x100	0.15	14.53		1200	51x96	0.15	5.8	
	12000	77x96	0.15	16.82		1500	51x115	0.15	7.03	
	15000	77x96	0.15	18.80		1800	54x130	0.15	8.14	
	18000	77x130	0.15	23.44		2200	64x100	0.15	8.86	
	22000	77x155	0.15	28.00		2700	64x115	0.15	10.43	
	27000	90x131	0.15	30.39		3300	64x130	0.15	12.17	
	33000	90x157	0.15	36.33		3900	77x115	0.15	12.85	
250 (300)	2200	51x75	0.15	5.64		4700	77x130	0.15	14.87	
	2700	51x75	0.15	6.25		5600	77x155	0.15	17.54	
	3300	51x96	0.15	7.69		6800	90x157	0.15	20.62	
	3900	51x115	0.15	9.07		8200	90x157	0.15	22.64	
	4700	64x96	0.15	9.79	10000	90x196	0.15	27.58		
	5600	64x96	0.15	10.68	12000	90x236	0.15	32.87		
	6800	64x115	0.15	12.73	500 (550)	470	51x75	0.20	2.96	
	8200	64x115	0.15	13.98		680	51x96	0.20	3.97	
	10000	64x130	0.15	16.30		820	51x115	0.20	4.72	
	12000	77x115	0.15	18.15		1000	51x130	0.20	5.52	
	15000	77x130	0.15	21.40			64x96	0.20	5.34	
	18000	77x155	0.15	25.33		1500	64x115	0.20	7.08	
	22000	90x157	0.15	29.67			77x96	0.20	6.75	
350 (400)	1200	51x75	0.15	5.21		1800	64x130	0.20	8.18	
	1500	51x80	0.15	5.99		2200	77x115	0.20	8.82	
	1800	51x96	0.15	7.10		2700	77x155	0.20	11.13	
	2200	51x96	0.15	7.85		3900	90x157	0.20	14.29	
	2700	51x130	0.15	9.97		550 (600)	390	51x75	0.20	2.70
	3300	51x130	0.15	11.02			560	51x96	0.20	3.60
		64x96	0.15	10.66	64x96			0.20	4.00	
	3900	64x115	0.15	12.53	680		51x115	0.20	4.30	
		64x130	0.15	14.53			64x115	0.20	4.76	
	4700	77x96	0.15	13.07	820		51x130	0.20	4.99	
		77x115	0.15	15.39			64x130	0.20	5.52	
	5600	77x130	0.15	17.89	1200		77x96	0.20	6.04	
	6800	77x155	0.15	21.22	1500		77x115	0.20	7.28	
8200	77x155	0.15	21.22	1800	77x130		0.20	8.41		
10000	90x157	0.15	25.00	2200	77x155		0.20	10.05		
12000	90x157	0.15	27.39	3300	90x157		0.20	13.15		
15000	90x196	0.15	33.78							

Jamicon Series : QP

Teapo Series : QP Standard · High Ripple Series

- Endurance:105°C 2000hours
- Recommended Applications :UPS · service system · press working equipment · charging equipment · inverter · converter
- Corresponding product to RoHS



■ SPECIFICATIONS

Item	Characteristics					
Category Temperature Range	-25~ +105°C					
Rated Voltage Range	160 ~ 500VDC					
Capacitance Tolerance	± 20 % (120Hz , 20°C)					
Leakage Current (20°C)	I ≤ 0.02CV or 5mA whichever is greater. (After rated voltage applied for 5 minutes) I : Max. leakage current (μA), C : Nominal capacitance (μF), V : Rated voltage (V)					
Dissipation Factor(MAX) (tan δ) (120Hz ,20°C)	WV	160	200	250	350	400~500
	tan δ	0.15	0.15	0.15	0.15	0.15
Low Temperature Stability Impedance Ratio (MAX)	Measurement frequency : 120Hz					
	Rated voltage(V)	160~500				
	Z-25°C / Z+20°C	8				
Endurance	After applying rated voltage with ripple current for 2000 hours at 105°C, the capacitors shall meet the following requirements.					
	Capacitance change	Within ± 20% of initial value				
	D.F. (tan δ)	Not more than 200% of specified value				
	Leakage current	Not more than the specified value				
Shelf Life	The following specifications shall be satisfied when the capacitors are restored to 20°C after exposing them for 1,000 hours at 105°C without voltage applied. Before the measurement, the capacitor shall be preconditioned by applying voltage according to item 4.1 of JIS C 5101-4.					

■ Dimensions [mm]

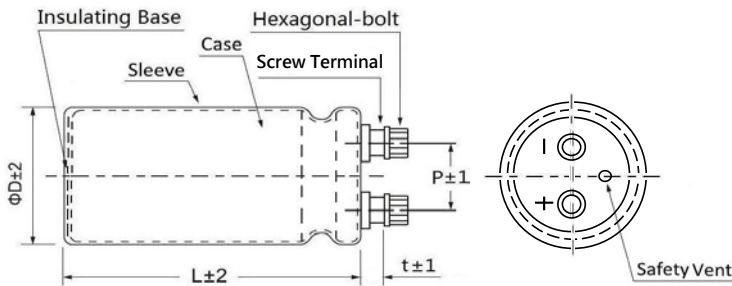

ΦD	P	t	Hexagonal-bolt
51	22.2	6.3	M5 × 0.8 × 10
64	28.5	6.3	M5 × 0.8 × 10
77	31.8	5.8	M5 × 0.8 × 10
90	31.6	5.8	M6 × 1.0 × 10

■ Multiplier for Ripple Current

Freq. (Hz)	60	120	300	1K	≥ 10K
coefficient	0.70	1.00	1.10	1.30	1.40

Temperature	40	60	85	105
coefficient	2.44	2.16	2.00	1.00

Jamicon Series : QP

Teapo Series : QP

■ STANDARD RATINGS

Rated Voltage (SurageVoltage) (V)	Cap (μ F)	Case size Φ DxL(mm)	$\tan \delta$	Ripple current (A/rms105°C) (120Hz)	Rated Voltage (SurageVoltage) (V)	Cap (μ F)	Case size Φ DxL(mm)	$\tan \delta$	Ripple current (A/rms105°C) (120Hz)	
160 (200)	4700	51x80	0.15	6.81	350 (400)	8200	77x155	0.15	18.11	
	5600	51x96	0.15	8.05		10000	90x157	0.15	21.94	
	6800	64x96	0.15	8.80	400 (450)	1000	51x75	0.15	4.08	
	8200	64x96	0.15	9.66		1200	51x96	0.15	4.97	
	10000	77x96	0.15	11.34		1500	51x96	0.15	5.56	
	15000	77x130	0.15	15.81		2200	64x96	0.15	7.65	
22000	90x131	0.15	19.87	3300		64x130	0.15	10.70		
200 (250)	3300	51x80	0.15	5.23		3900	64x155	0.15	12.59	
	4700	51x96	0.15	6.76		4700	77x130	0.15	14.16	
	5600	64x96	0.15	7.99		5600	77x155	0.15	16.70	
	6800	64x115	0.15	9.52	6800	90x157	0.15	16.83		
	8200	77x66	0.15	10.27	8200	90x157	0.15	18.48		
	10000	77x115	0.15	12.24	10000	90x196	0.15	22.52		
250 (300)	15000	90x131	0.15	16.47	450 (500)	1000	51x96	0.15	4.54	
	2200	51x75	0.15	4.53		1200	51x115	0.15	5.39	
	3300	51x96	0.15	6.18		1500	51x115	0.15	6.02	
	3900	64x96	0.15	6.69		2200	64x115	0.15	8.28	
	4700	64x115	0.15	7.94		3300	64x130	0.15	10.70	
	5600	77x96	0.15	8.91		3900	77x121	0.15	12.50	
	6800	77x115	0.15	10.60		4700	77x144	0.15	14.81	
	8200	77x130	0.15	12.27		5600	90x145	0.15	15.49	
	10000	77x155	0.15	14.65		6800	90x196	0.15	19.50	
	15000	90x157	0.15	17.81		8200	90x196	0.15	21.41	
350 (400)	1000	51x75	0.15	4.08	500 (550)	820	51x115	0.20	3.86	
	1200	51x75	0.15	4.47		1000	51x130	0.20	4.50	
	1500	51x96	0.15	5.56			64x96	0.2	4.37	
	1800	51x96	0.15	6.09		1200	64x115	0.20	5.18	
	2200	51x115	0.15	7.29		1500	64x130	0.20	6.12	
	2700	64x96	0.15	8.48			77x96	0.2	5.66	
	3300	64x115	0.15	10.13		1800	77x115	0.20	6.69	
	3900	64x115	0.15	11.02		2700	77x155	0.20	9.33	
	4700	64x130	0.15	12.77		1900	90x157	0.20	11.70	
	5600	77x130	0.15	15.46		6800	90x236	0.20	18.54	
	6800	77x130	0.15	17.03						

Jamicon Series : RP

Teapo Series : RP Wide temperature range standard Series



- Endurance: 105°C 2000hours
- Recommended Applications :UPS、service system、press working equipment、charging equipment、inverter、converter
- Corresponding product to RoHS

■ SPECIFICATIONS

Item	Characteristics		
Category Temperature Range	-40 ~ +105°C		-25 ~ +105°C
Rated Voltage Range	10~ 100VDC		160~450VDC
Capacitance Tolerance	± 20 % (120Hz, 20°C)		
Leakage Current (20°C)	I ≤ 0.02CV or 5mA whichever is greater. (After rated voltage applied for 5 minutes) I : Max. leakage current (μA), C : Nominal capacitance (μF), V : Rated voltage (V)		
Dissipation Factor(MAX) (tan δ) (120Hz, 20°C)	Shown in the table of standard rating		
Low Temperature Stability Impedance Ratio (MAX)	Measurement frequency : 120Hz		
	Rated voltage(V)	10~100	160~450
	Z-25°C / Z+20°C	-	8
Z-40°C / Z+20°C	12	-	
Endurance	After applying rated voltage with ripple current for 2000 hours at 105°C, the capacitors shall meet the following requirements.		
	Capacitance change	Within ± 20% of initial value	
	D.F. (tan δ)	Not more than 200% of specified value	
	Leakage current	Not more than the specified value	
Shelf Life	The following specifications shall be satisfied when the capacitors are restored to 20°C after exposing them for 1,000 hours at 105°C without voltage applied. Before the measurement, the capacitor shall be preconditioned by applying voltage according to item 4.1 of JIS C 5101-4.		

■ Dimensions [mm]

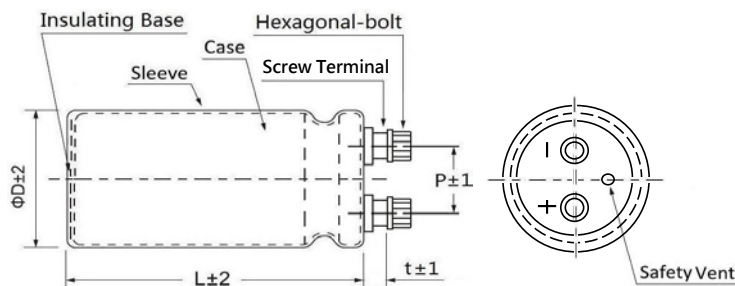

ΦD	P	t	Hexagonal-bolt
35	12.7	6.3	M5 × 0.8 × 10
51	21.8	6.3	M5 × 0.8 × 10
64	28.2	6.3	M5 × 0.8 × 10
77	31.4	5.8	M5 × 0.8 × 10
90	31.4	5.8	M5 × 0.8 × 10

■ Multiplier for Ripple Current

Freq. (Hz)	120	1K	10K	100K
W.V	coefficient			
10~35V	1.00	1.05	1.10	1.10
50~100V	1.00	1.10	1.15	1.15
160~450V	1.00	1.20	1.30	1.35
Temperature	55	70	85	105
coefficient	≤ 250V	2.50	2.00	1.40
	≥ 350V	2.00	1.50	1.20

Jamicon Series : RP

Teapo Series : RP

■ STANDARD RATINGS

Rated Voltage (SurageVoltage) (V)	Cap (μF)	Case size Φ DxL(mm)	tan δ	R.C (A/rms,105°C) (120Hz)	Rated Voltage (SurageVoltage) (V)	Cap (μF)	Case size Φ DxL(mm)	tan δ	R.C (A/rms,105°C) (120Hz)	
10 (13)	33000	35x50	0.80	3.72	100 (125)	47000	90x131	0.25	15.05	
	47000	35x60	0.80	4.81		160 (200)	1000	35x50	0.15	1.50
	56000	35x70	0.80	5.61			1500	35x60	0.15	1.98
	68000	35x80	0.80	6.57			2200	35x70	0.15	2.57
	100000	51x70	1.00	7.67			3300	35x90	0.15	3.52
	150000	51x90	1.00	10.46			4700	51x80	0.15	4.54
	220000	64x96	1.20	13.53			5600	51x90	0.15	5.22
	330000	64x115	1.20	17.92			6800	64x96	0.15	5.89
16 (20)	22000	35x50	0.70	3.25			8200	64x96	0.15	6.46
	33000	35x60	0.70	4.31			10000	77x96	0.15	7.56
	47000	35x80	0.70	5.84			15000	77x130	0.15	10.54
	56000	35x90	0.70	6.72		22000	90x131	0.15	13.30	
	68000	51x70	0.90	6.66		200 (250)	1000	35x60	0.15	1.62
	100000	51x90	0.90	9.00			1500	35x70	0.15	2.12
	150000	64x96	1.00	11.22			2200	35x90	0.15	2.88
	220000	64x115	1.00	14.69			3300	51x80	0.15	3.49
330000	77x115	1.20	18.24	4700	51x90		0.15	4.38		
25 (32)	22000	35x60	0.35	4.59	5600		64x96	0.15	5.34	
	33000	35x80	0.35	6.39	6800		64x115	0.15	6.37	
	47000	35x90	0.35	8.04	8200		77x96	0.15	6.85	
	56000	51x70	0.40	8.31	10000		77x115	0.15	8.16	
	68000	51x90	0.40	10.21	15000		90x131	0.15	10.98	
	100000	64x96	0.40	11.28	250 (300)	1000	35x70	0.15	1.73	
	150000	64x115	0.80	12.94		1500	35x90	0.15	2.38	
	220000	77x115	1.00	14.83		2200	51x70	0.15	2.94	
330000	90x131	1.00	19.94	3300		51x90	0.15	4.01		
35 (44)	15000	35x60	0.30	4.09		3900	64x96	0.15	4.46	
	22000	35x80	0.30	5.63		4700	64x115	0.15	5.29	
	33000	51x70	0.45	6.56		5600	77x96	0.15	5.94	
	47000	51x80	0.45	8.29		6800	77x115	0.15	7.07	
	56000	51x90	0.45	9.53		8200	77x130	0.15	8.18	
	68000	51x115	0.50	11.11		10000	77x155	0.15	9.76	
	100000	64x115	0.60	12.20	15000	90x157	0.15	11.87		
	150000	77x115	0.70	13.90	350 (400)	1000	51x65	0.15	2.40	
220000	90x131	0.70	17.42	1500		51x70	0.15	3.03		
50 (63)	8200	35x60	0.25	3.18		2200	51x96	0.15	4.21	
	10000	35x70	0.25	3.75		3300	64x96	0.15	5.47	
	15000	35x80	0.25	4.88		3900	64x115	0.15	6.43	
	22000	51x70	0.35	5.57		4700	64x130	0.15	7.45	
	33000	51x90	0.35	7.60		5600	77x115	0.15	7.94	
	47000	64x96	0.40	9.48		6800	77x130	0.15	9.23	
	56000	64x96	0.40	10.34		8200	77x155	0.15	10.95	
	68000	64x115	0.45	11.62		10000	90x157	0.15	12.25	
	100000	77x115	0.50	14.14	400 (450)	1000	51x70	0.15	2.47	
	150000	90x131	0.50	19.02		1500	51x90	0.15	3.38	
63 (79)	6800	35x70	0.20	3.31		2200	64x96	0.15	4.46	
	8200	35x80	0.20	3.86		3300	64x130	0.15	6.24	
	10000	35x90	0.20	4.50		3900	64x155	0.15	7.34	
	15000	51x70	0.25	4.95		4700	77x130	0.15	7.97	
	22000	51x90	0.25	6.68		5600	77x155	0.15	9.39	
	33000	64x96	0.30	8.73		6800	90x157	0.15	10.94	
	47000	64x115	0.35	10.43		8200	90x157	0.15	12.01	
	56000	77x96	0.40	10.96		10000	90x196	0.15	14.64	
	68000	77x115	0.40	13.03	450 (500)	1000	51x90	0.15	2.94	
	100000	90x131	0.40	17.36		1500	51x115	0.15	4.02	
100 (125)	5600	35x90	0.15	4.59		2200	64x115	0.15	5.17	
	6800	51x70	0.15	5.16		3300	64x130	0.15	6.69	
	8200	51x80	0.15	6.00		3900	77x121	0.15	7.82	
	10000	51x90	0.15	6.97		4700	77x144	0.15	9.26	
	15000	64x96	0.15	7.57		5600	90x145	0.15	11.06	
	22000	77x96	0.25	8.69		6800	90x196	0.15	13.93	
	33000	77x130	0.25	12.11						

Jamicon Series : MP

Teapo Series : MP High voltage · Long life Series

- Endurance:85°C 5000hours
- Recommended Applications :UPS · service system · press working equipment · charging equipment · inverter · converter
- Corresponding product to RoHS



■ SPECIFICATIONS

Item	Characteristics			
Category Temperature Range	-40 ~ +85°C			
Rated Voltage Range	350 ~ 450VDC			
Capacitance Tolerance	± 20 % (120Hz, 20°C)			
Leakage Current (20°C)	I ≤ 0.02CV or 5mA whichever is greater. (After rated voltage applied for 5 minutes) I : Max. leakage current (µA), C : Nominal capacitance (µF), V : Rated voltage (V)			
Dissipation Factor(MAX) (tan δ) (120Hz, 20°C)	WV	350	400	450
	tan δ	0.15	0.15	0.15
Low Temperature Stability Impedance Ratio (MAX)	Rated voltage(V)			
	Rated voltage(V)	350~450		
Endurance	After applying rated voltage with ripple current for 5000 hours at 85°C, the capacitors shall meet the following requirements.			
	Capacitance change	Within ± 20% of initial value		
	D.F. (tan δ)	Not more than 200% of specified value		
Shelf Life	The following specifications shall be satisfied when the capacitors are restored to 20°C after exposing them for 1,000 hours at 85°C without voltage applied. Before the measurement, the capacitor shall be preconditioned by applying voltage according to item 4.1 of JIS C 5101-4.			
	Leakage current	Not more than the specified value		

■ Dimensions [mm]

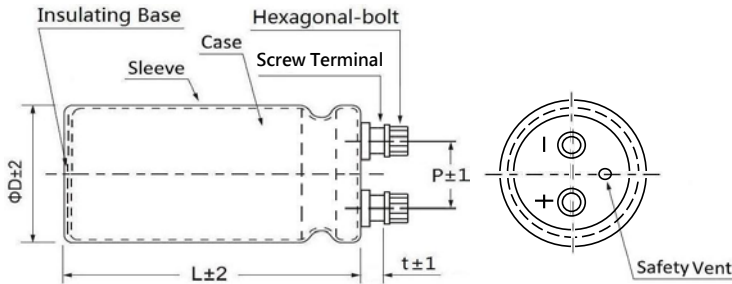

ΦD	P	t	Hexagonal-bolt
51	22.2	6.3	M5 × 0.8 × 10
64	28.5	6.3	M5 × 0.8 × 10
77	31.8	5.8	M5 × 0.8 × 10
90	31.6	5.8	M6 × 1.0 × 10

■ Multiplier for Ripple Current

Freq. (Hz)	60	120	300	1K	≥ 10K
coefficient	0.70	1.00	1.10	1.30	1.40

Temperature	40	60	85
coefficient	1.89	1.67	1.00

Jamicon Series : MP

Teapo Series : MP

■ STANDARD RATINGS

Rated Voltage (SurageVoltage) (V)	Cap (μ F)	Case size Φ DxL(mm)	$\tan \delta$	Ripple current (A/rms85°C) (120Hz)	Rated Voltage (SurageVoltage) (V)	Cap (μ F)	Case size Φ DxL(mm)	$\tan \delta$	Ripple current (A/rms85°C) (120Hz)
350 (400)	1200	51x75	0.15	5.21	400 (450)	4700	64x155	0.15	15.72
	1500	51x75	0.15	5.82			77x115	0.15	14.10
	1800	51x96	0.15	7.1		5600	64x195	0.15	19.06
	2200	51x96	0.15	7.85			77x130	0.15	16.23
	2700	51x130	0.15	9.97		6800	77x155	0.15	19.33
	3300	51x130	0.15	11.02		8200	90x157	0.15	22.64
	3900	64x115	0.15	12.5		10000	90x157	0.15	25.00
	4700	64x130	0.15	14.53		12000	90x196	0.15	30.22
	5600	64x155	0.15	17.16		15000	90x236	0.15	36.74
		77x115	0.15	15.39		450 (500)	1000	51x75	0.15
	6800	64x195	0.15	21	1200		51x96	0.15	6.1
		77x130	0.15	17.88	1500		51x115	0.15	7.4
	8200	77x155	0.15	21.22	1800		51x130	0.15	8.54
	10000	90x157	0.15	25	2200		64x96	0.15	8.93
	12000	90x157	0.15	27.39	2700		64x115	0.15	10.69
	15000	90x196	0.15	33.78	3300		64x130	0.15	12.48
18000	90x236	0.15	40.25	3900	64x155		0.15	14.68	
					77x115		0.15	13.56	
400 (450)	1000	51x75	0.15	4.76	4700		64x195	0.15	17.91
	1200	51x75	0.15	5.21		77x130	0.15	15.69	
	1500	51x96	0.15	6.48	5600	77x155	0.15	18.51	
	1800	51x96	0.15	7.10	6800	90x157	0.15	21.21	
	2200	51x130	0.15	8.99	8200	90x157	0.15	23.29	
	2700	64x96	0.15	9.64	10000	90x196	0.15	28.37	
	3300	64x115	0.15	11.53	12000	90x236	0.15	33.80	
	3900	64x130	0.15	13.23					

Jamicon Series : XP

Teapo Series : XP High voltage · Long life Series

- Endurance:105°C 5000hours
- Recommended Applications :UPS · service system · press working equipment · charging equipment · inverter · converter
- Corresponding product to RoHS



■ SPECIFICATIONS

Item	Characteristics												
Category Temperature Range	-40 ~ +105°C												
Rated Voltage Range	200 ~ 450VDC												
Capacitance Tolerance	± 20 % (120Hz, 20°C)												
Leakage Current (20°C)	$I \leq 0.02CV$ or 5mA whichever is greater. (After rated voltage applied for 5 minutes) I : Max. leakage current (μA), C : Nominal capacitance (μF), V : Rated voltage (V)												
Dissipation Factor(MAX) (tan δ) (120Hz, 20°C)	<table border="1"> <tr> <td>WV</td> <td>200</td> <td>250</td> <td>350</td> <td>400</td> <td>450</td> </tr> <tr> <td>tan δ</td> <td>0.15</td> <td>0.15</td> <td>0.15</td> <td>0.15</td> <td>0.15</td> </tr> </table>	WV	200	250	350	400	450	tan δ	0.15	0.15	0.15	0.15	0.15
WV	200	250	350	400	450								
tan δ	0.15	0.15	0.15	0.15	0.15								
Low Temperature Stability Impedance Ratio (MAX)	Measurement frequency : 120Hz <table border="1"> <tr> <td>Rated voltage(V)</td> <td>200~450</td> </tr> <tr> <td>Z-25°C / Z+20°C</td> <td>8</td> </tr> </table>	Rated voltage(V)	200~450	Z-25°C / Z+20°C	8								
Rated voltage(V)	200~450												
Z-25°C / Z+20°C	8												
Endurance	After applying rated voltage with ripple current for 5000 hours at 105°C, the capacitors shall meet the following requirements. <table border="1"> <tr> <td>Capacitance change</td> <td>Within ± 20% of initial value</td> </tr> <tr> <td>D.F. (tan δ)</td> <td>Not more than 200% of specified value</td> </tr> <tr> <td>Leakage current</td> <td>Not more than the specified value</td> </tr> </table>	Capacitance change	Within ± 20% of initial value	D.F. (tan δ)	Not more than 200% of specified value	Leakage current	Not more than the specified value						
Capacitance change	Within ± 20% of initial value												
D.F. (tan δ)	Not more than 200% of specified value												
Leakage current	Not more than the specified value												
Shelf Life	The following specifications shall be satisfied when the capacitors are restored to 20°C after exposing them for 1,000 hours at 105°C without voltage applied. Before the measurement, the capacitor shall be preconditioned by applying voltage according to item 4.1 of JIS C 5101-4.												

■ 尺寸图

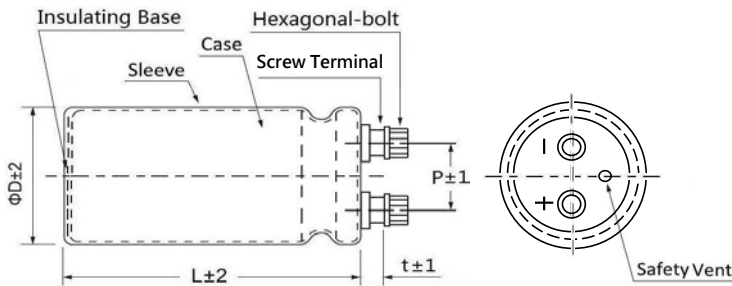

ΦD	P	t	Hexagonal-bolt
51	22.2	6.3	M5 × 0.8 × 10
64	28.5	6.3	M5 × 0.8 × 10
77	31.8	5.8	M5 × 0.8 × 10
90	31.6	5.8	M6 × 1.0 × 10

■ 纹波电流频率修正系数

Freq. (Hz)	60(50)	120	300	1K	≥ 10K
coefficient	0.70	1.00	1.10	1.30	1.40

Temperature	40	60	85	105
coefficient	2.44	2.16	2.00	1.00

Jamicon Series : XP

Teapo Series : XP

■ STANDARD RATINGS

Rated Voltage (SurageVoltage) (V)	Cap (μ F)	Case size Φ DxL(mm)	$\tan \delta$	Ripple current (A/rms105°C) (120Hz)	Rated Voltage (SurageVoltage) (V)	Cap (μ F)	Case size Φ DxL(mm)	$\tan \delta$	Ripple current (A/rms105°C) (120Hz)
200 (250)	2200	51x80	0.20	2.92	400 (450)	1200	51x96	0.15	4.14
	3300	51x100	0.20	3.94		1500	51x115	0.15	5.02
	4700	64x100	0.20	5.13		1800	51x130	0.15	5.81
	6800	64x121	0.20	6.71		2200	51x130	0.15	6.43
	10000	77x121	0.20	8.31			64x96	0.15	6.22
	15000	77x144	0.20	10.98		2700	64x115	0.15	7.45
	22000	90x145	0.20	11.40		3300	64x130	0.15	8.69
	33000	90x236	0.20	17.34		3900	64x155	0.15	10.23
250 (300)	1500	51x80	0.20	2.41			77x115	0.15	9.18
	2200	51x100	0.20	3.21		4700	64x195	0.15	12.47
	3300	64x100	0.20	4.47			77x130	0.15	10.62
	4700	64x121	0.20	5.80		5600	64x195	0.15	13.61
	6800	77x121	0.20	7.15			77x155	0.15	12.53
	10000	90x145	0.20	9.36		6800	90x157	0.15	14.73
	15000	90x171	0.20	12.36		8200	90x157	0.15	16.17
	22000	90x236	0.20	17.30		10000	90x196	0.15	19.70
350 (400)	1000	51x75	0.15	3.06	12000	90x236	0.15	23.48	
	1200	51x75	0.15	3.35	450 (500)	1000	51x96	0.15	4.25
	1500	51x96	0.15	4.17		1200	51x115	0.15	5.05
	1800	51x96	0.15	4.57		1500	51x130	0.15	5.97
	2200	51x130	0.15	5.78		1800	64x96	0.15	6.20
	2700	64x96	0.15	6.00		2200	64x115	0.15	7.41
	3300	64x115	0.15	7.18		2700	64x130	0.15	8.67
	3900	64x130	0.15	8.24			77x115	0.15	8.69
	4700	64x155	0.15	9.79		3300	64x155	0.15	10.37
		77x115	0.15	8.95			77x130	0.15	10.14
	5600	64x196	0.15	11.87		3900	64x195	0.15	12.53
		77x130	0.15	10.30		4700	77x155	0.15	13.07
	6800	77x130	0.15	12.27		5600	77x195	0.15	15.82
	8200	90x157	0.15	13.86			90x157	0.15	14.89
	10000	90x157	0.15	15.31		6800	90x196	0.15	18.10
	12000	90x196	0.15	18.50		8200	90x196	0.15	19.88
15000	90x236	0.15	22.50	10000		90x236	0.15	23.88	
400 (450)	1000	51x75	0.15	3.40					

Jamicon Series : JP

Teapo Series : JP High voltage · Long life Series

- Endurance:85°C 10000hours
- Recommended Applications :UPS · service system · press working equipment · charging equipment · inverter · converter
- Corresponding product to RoHS



■ SPECIFICATIONS

Item	Characteristics								
Category Temperature Range	-40 ~ +85°C								
Rated Voltage Range	350 ~ 450VDC								
Capacitance Tolerance	± 20 % (120Hz , 20°C)								
Leakage Current (20°C)	$I \leq 0.02CV$ or 5mA whichever is greater. (After rated voltage applied for 5 minutes) I : Max. leakage current (μA), C : Nominal capacitance (μF), V : Rated voltage (V)								
Dissipation Factor(MAX) (tan δ) (120Hz ,20°C)	<table border="1"> <tr> <td>WV</td> <td>350</td> <td>400</td> <td>450</td> </tr> <tr> <td>tan δ</td> <td>0.15</td> <td>0.15</td> <td>0.15</td> </tr> </table>	WV	350	400	450	tan δ	0.15	0.15	0.15
WV	350	400	450						
tan δ	0.15	0.15	0.15						
Low Temperature Stability Impedance Ratio (MAX)	Measurement frequency : 120Hz <table border="1"> <tr> <td>Rated voltage(V)</td> <td>350~450</td> </tr> <tr> <td>Z-25°C / Z+20°C</td> <td>8</td> </tr> </table>	Rated voltage(V)	350~450	Z-25°C / Z+20°C	8				
Rated voltage(V)	350~450								
Z-25°C / Z+20°C	8								
Endurance	After applying rated voltage with ripple current for 10000 hours at 85°C, the capacitors shall meet the following requirements. <table border="1"> <tr> <td>Capacitance change</td> <td>Within ± 20% of initial value</td> </tr> <tr> <td>D.F. (tan δ)</td> <td>Not more than 200% of specified value</td> </tr> <tr> <td>Leakage current</td> <td>Not more than the specified value</td> </tr> </table>	Capacitance change	Within ± 20% of initial value	D.F. (tan δ)	Not more than 200% of specified value	Leakage current	Not more than the specified value		
Capacitance change	Within ± 20% of initial value								
D.F. (tan δ)	Not more than 200% of specified value								
Leakage current	Not more than the specified value								
Shelf Life	The following specifications shall be satisfied when the capacitors are restored to 20°C after exposing them for 1,000 hours at 105°C without voltage applied. Before the measurement, the capacitor shall be preconditioned by applying voltage according to item 4.1 of JIS C 5101-4.								

■ Dimensions [mm]

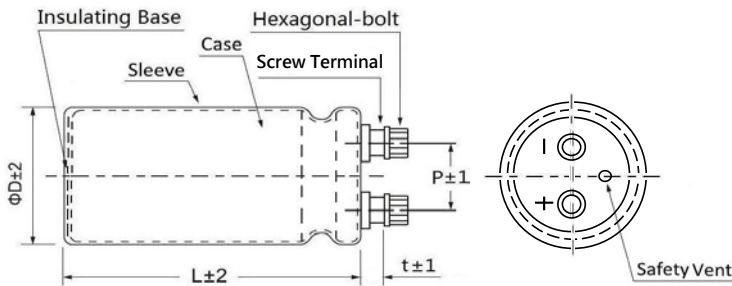

ΦD	P	t	Hexagonal-bolt
51	22.2	6.3	M5 × 0.8 × 10
64	28.5	6.3	M5 × 0.8 × 10
77	31.8	5.8	M5 × 0.8 × 10
90	31.6	5.8	M6 × 1.0 × 10

■ Multiplier for Ripple Current

Freq. (Hz)	60	120	300	1K	≥ 10K
coefficient	0.70	1.00	1.10	1.30	1.40

Temperature	40	60	85
coefficient	1.89	1.67	1.00

Jamicon Series : JP

Teapo Series : JP

■ STANDARD RATINGS

Rated Voltage (SurageVoltage) (V)	Cap (μ F)	Case size Φ DxL(mm)	$\tan \delta$	Ripple current (A/rms85°C) (120Hz)	Rated Voltage (SurageVoltage) (V)	Cap (μ F)	Case size Φ DxL(mm)	$\tan \delta$	Ripple current (A/rms85°C) (120Hz)
350 (400)	1000	51x75	0.15	5.7	400 (450)	3900	77x115	0.15	12.8
	1200	51x75	0.15	6.3		4700	64x195	0.15	16.6
	1500	51x96	0.15	7.8			77x130	0.15	14.9
	1800	51x96	0.15	8.5		5600	64x195	0.15	17.6
	2200	51x130	0.15	10.8			77x155	0.15	17.0
	2700	64x96	0.15	11.5		6800	90x157	0.15	19.8
	3300	64x115	0.15	13.7		8200	90x157	0.15	21.7
	3900	64x130	0.15	15.8		10000	90x196	0.15	25.5
	4700	64x155	0.15	18.7		12000	90x236	0.15	20.4
		77x115	0.15	17.6		450 (500)	1000	51x96	0.15
	5600	64x195	0.15	22	1200		51x115	0.15	7
		77x130	0.15	20.3	1500		51x130	0.15	8.3
	6800	77x155	0.15	23.4	1800		64x96	0.15	8.7
	8200	90x157	0.15	27.2	2200		64x115	0.15	10.5
	10000	90x157	0.15	30	2700		64x130	0.15	12.2
12000	90x196	0.15	36.3	77x115			0.15	12.5	
15000	90x236	0.15	42.5	3300	64x155		0.15	14.6	
400 (450)	1000	51x75	0.15		4.6		77x130	0.15	14.5
	1200	51x96	0.15	5.6	3900		64x195	0.15	17.7
	1500	51x115	0.15	6.7	4700		77x155	0.15	18.1
	1800	51x130	0.15	7.8	5600		77x195	0.15	21.9
	2200	64x96	0.15	8.3			90x157	0.15	21.00
	2700	64x115	0.15	9.9	6800		90x196	0.15	25.40
	3300	64x130	0.15	11.6	8200		90x196	0.15	28
	3900	64x155	0.15	13.6	10000	90x236	0.15	32.4	

Jamicon Series : EP

Teapo Series : EP High voltage · Long life Series

- Endurance:105°C 10000hours
- Recommended Applications :UPS · service system · press working equipment · charging equipment · inverter · converter
- Corresponding product to RoHS



■ SPECIFICATIONS

Item	Characteristics								
Category Temperature Range	-40 ~ +105°C								
Rated Voltage Range	350 ~ 450VDC								
Rated Capacitance Range	1000 ~ 15000 µF								
Capacitance Tolerance	± 20 % (120Hz , 20°C)								
Leakage Current (20°C)	$I \leq 0.02CV$ or 5mA whichever is greater. (After rated voltage applied for 5 minutes) I : Max. leakage current (µA), C : Nominal capacitance (µF), V : Rated voltage (V)								
Dissipation Factor(MAX) (tan δ) (120Hz ,20°C)	<table border="1"> <tr> <td>WV</td> <td>350</td> <td>400</td> <td>450</td> </tr> <tr> <td>tan δ</td> <td>0.15</td> <td>0.15</td> <td>0.15</td> </tr> </table>	WV	350	400	450	tan δ	0.15	0.15	0.15
	WV	350	400	450					
tan δ	0.15	0.15	0.15						
Low Temperature Stability Impedance Ratio (MAX)	Measurement frequency : 120Hz								
	<table border="1"> <tr> <td>Rated voltage(V)</td> <td>350~450</td> </tr> <tr> <td>Z-25°C / Z+20°C</td> <td>8</td> </tr> </table>	Rated voltage(V)	350~450	Z-25°C / Z+20°C	8				
Rated voltage(V)	350~450								
Z-25°C / Z+20°C	8								
Endurance	After applying rated voltage with ripple current for 10000 hours at 105°C, the capacitors shall meet the following requirements.								
	<table border="1"> <tr> <td>Capacitance change</td> <td>Within ± 20% of initial value</td> </tr> <tr> <td>D.F. (tan δ)</td> <td>Not more than 200% of specified value</td> </tr> <tr> <td>Leakage current</td> <td>Not more than the specified value</td> </tr> </table>	Capacitance change	Within ± 20% of initial value	D.F. (tan δ)	Not more than 200% of specified value	Leakage current	Not more than the specified value		
	Capacitance change	Within ± 20% of initial value							
D.F. (tan δ)	Not more than 200% of specified value								
Leakage current	Not more than the specified value								
Shelf Life	The following specifications shall be satisfied when the capacitors are restored to 20°C after exposing them for 1,000 hours at 105°C without voltage applied. Before the measurement, the capacitor shall be preconditioned by applying voltage according to item 4.1 of JIS C 5101-4.								

■ Dimensions [mm]

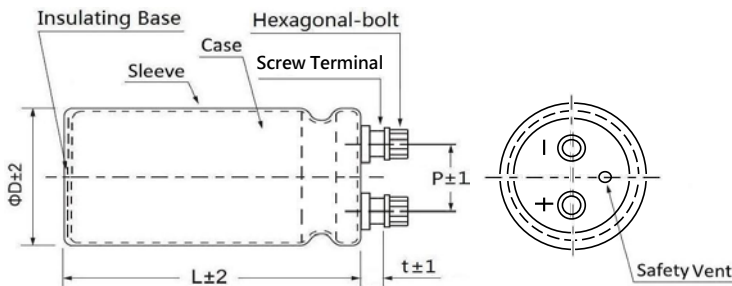

ΦD	P	t	Hexagonal-bolt
51	22.2	6.3	M5 × 0.8 × 10
64	28.5	6.3	M5 × 0.8 × 10
77	31.8	5.8	M5 × 0.8 × 10
90	31.6	5.8	M6 × 1.0 × 10

■ Multiplier for Ripple Current

Freq. (Hz)	60(50)	120	300	1K	≥ 10K
coefficient	0.70	1.00	1.10	1.30	1.40

Temperature	40	60	85	105
coefficient	2.44	2.16	2.00	1.00

Jamicon Series : EP

Teapo Series : EP

■ STANDARD RATINGS

Rated Voltage (SurageVoltage) (V)	Cap (μ F)	Case size Φ DxL(mm)	$\tan \delta$	Ripple current (A/rms105°C) (120Hz)	Rated Voltage (SurageVoltage) (V)	Cap (μ F)	Case size Φ DxL(mm)	$\tan \delta$	Ripple current (A/rms105°C) (120Hz)
350 (400)	1000	51x75	0.15	5.6	400 (450)	3900	77x115	0.15	15.3
	1200	51x75	0.15	6.1		4700	64x195	0.15	19.8
	1500	51x96	0.15	7.6			77x130	0.15	17.7
	1800	51x96	0.15	8.3		5600	64x195	0.15	21.6
	2200	51x130	0.15	10.5			77x155	0.15	20.9
	2700	64x96	0.15	10.9		6800	90x157	0.15	23.7
	3300	64x115	0.15	13.1		8200	90x157	0.15	26.1
	3900	64x130	0.15	15.0		10000	90x196	0.15	31.8
	4700	64x155	0.15	17.8		12000	90x236	0.15	37.8
		77x115	0.15	16.8		450 (500)	1000	51x96	0.15
	5600	64x195	0.15	21.6	1200		51x115	0.15	7.4
		77x130	0.15	19.3	1500		51x130	0.15	8.7
	6800	77x144	0.15	22.3	1800		64x115	0.15	9.7
	8200	90x157	0.15	26.1	2200		64x115	0.15	10.7
	10000	90x157	0.15	28.8	2700		64x130	0.15	12.5
12000	90x196	0.15	34.8	77x115			0.15	12.7	
15000	90x236	0.15	42.3	3300	64x155		0.15	14.9	
400 (450)	1000	51x75	0.15		5.6		77x130	0.15	14.8
	1200	51x96	0.15	6.8	3900		64x195	0.15	18
	1500	51x115	0.15	8.2	4700		77x155	0.15	19.1
	1800	51x130	0.15	9.5	5600		77x195	0.15	23.20
	2200	64x96	0.15	9.7			90x157	0.15	21.50
	2700	64x115	0.15	11.8	6800		90x196	0.15	26.2
	3300	64x130	0.15	13.8	8200		90x196	0.15	28.8
	3900	64x155	0.15	16.2	10000	90x236	0.15	34.5	

Quality and Environmental Management
System Certification

TEAPO ELECTRONIC (DONGGUAN) CO., LTD

Standara	Certificate Number
ISO 9001 : 2015	N° 2018/79091.1
IATF 16949 : 2016	N° 79086 N° IATF : 0304774
IECQ QC080000 : 2017	IECQ-H AFNOR 18.0006
ISO 14001 : 2015	IAS21E003R0
ISO 45001:2018	IAS21S002R0
CQC	201300103010100174

SUZHOU KAIMEI ELECTRONIC CO., LTD

Standara	Certificate Number
ISO9001 : 2015	15/18Q0960R00
IATF 16949 : 2016	289488
ISO14001 : 2015	15/18E5742R41
ISO45001 : 2018	15/20S0504R00

JAMICON TEAPO



凯美电机股份有限公司

KAIMEI ELECTRONIC CORP.

Tel : +886-2-2698-1010 Fax: +886-2-2698-0386

Email : sales@jamicon.teapo.com

地址:新北市汐止区新台五路一段81号13楼-3
13th. FL., No.81, SEC. 1, XINTAI 5th RD. XIZHI DIST.
New Taipei City 22101, Taiwan R.O.C



智宝电子（东莞）有限公司

TEAPO ELECTRONIC (DONGGUAN) CO., LTD

Tel : +86-769-8791-4676 Fax : +86-769-8791-4770

Email : sales@jamicon.teapo.com

地址:广东省东莞市塘厦镇高丽工业区高丽一路6A2.6A3号
No. 6A3.6A2, Gaoli 1st Rd. Gaoli Ind. Zone, Tangxia Town,
Dongguan City, Guangdong 523726, China.



苏州凯美电子有限公司

SUZHOU KAIMEI ELECTRONIC CO., LTD

Tel : +86-512-6636-8640 Fax : +86-512-6538-1888

Email : sales@jamicon.teapo.com

地址 : 江苏省苏州市相城区望亭镇聚福路2号
No. 2 Jufu Road, Wangting Town, Xiangcheng District,
Suzhou City, Jiang Su, China.